

Vacuum Unit

ZK2 Series

Vacuum Ejector

Vacuum Pump System



RoHS

Energy saving ejector

Digital pressure switch for vacuum with energy saving function cuts supply air when the pressure reached the desired vacuum.

Air consumption 90% reduction*

*Based on SMC's measuring conditions

More efficient ejector

Suction flow 50% increase

Air consumption 30% reduction

(Compared to other SMC single stage ejectors)

Two-stage ejector

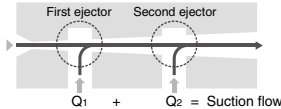

Compact / Lightweight

Volume 88 cm³ 28% reduction

Weight 81g 59% reduction

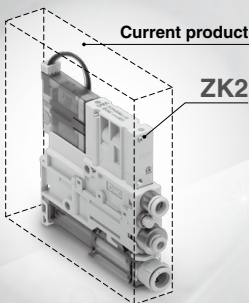

Reduced-wiring

D-sub connector/Flat ribbon cable/Individual wiring

High-noise reduction silencer added

Low noise: 46 dB^{*1}(A)

**Suction flow rate:
Improved by up to approx. 20%*2**

*1 Nozzle size: $\phi 0.7$

*2 Nozzle size: $\phi 1.5$

(Based on SMC's measuring conditions)

**High-noise reduction
silencer**

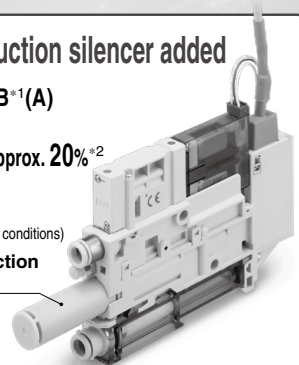

ZK2
ZQ
ZR
ZB
ZA
ZX
ZM
ZL
ZH
ZH-X267
ZHP
ZU
VQD-V

Energy saving ejector

Digital pressure switch with energy saving function

reduces air consumption by 90%*.

*Based on SMC's measuring conditions

Digital pressure switch for vacuum with energy saving function

While the suction signal is ON, the ON/OFF operation of the supply valve is also performed automatically within the set value.

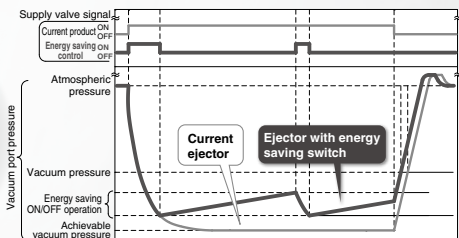
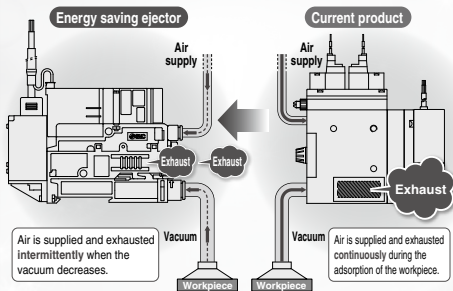

Power consumption cost per year reduced by 70,594 JPY/year

The energy saving function shortens the exhaust time, which reduces the annual power consumption cost.

	Power consumption cost per year	Engerizing time per year	Exhaust time	Compressor's consumption per unit time
ZK2/With energy saving function	5,344 JPY/year	1875 h/year	0.6 s	0.19 kWh
Current product	75,938 JPY/year	18750 h/year	6 s	0.27 kWh

With energy saving function

Cost conditions

- Electric power charge: 15 JPY/kWh, Operating hours: 10 hours/day, Operating days: 250 days/year, When 10 units are used
- Power consumption of the compressor is the theoretical value from the air consumption of each product at 0.35 MPa.

Energy saving efficiency

Improved low noise and suction flow by adoption of a high-noise reduction silencer

Low noise

46 dB*(A)

*Nozzle size: $\phi 0.7$

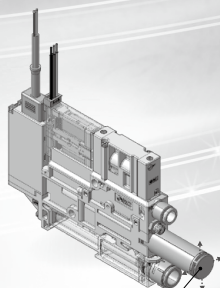

High-noise reduction silencer

The exhaust is discharged directly to atmosphere, cutting off the unpleasant frequency while exhibiting the maximum possible vacuum performance.

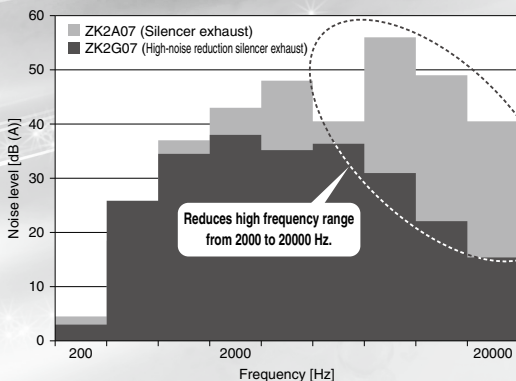

Suction flow rate

Improved by up to approx. 20%

Nozzle size	Exhaust type	Maximum suction flow rate [L/min (ANR)]	
		40	80
$\phi 1.5$	High-noise reduction silencer exhaust	67	83
	Silencer exhaust	67	67

Annotation: Approx. 20% increase in suction flow rate for the high-noise reduction silencer exhaust at 80 L/min ANR.

All in One Piping Wiring Installation time reduced!!

Dual 2 port valve (Release valve/Supply valve)

■ Supply valve: Self-holding

Even if there is a power cut, the vacuum is maintained as long as there is supply air.

① The vacuum is maintained during power failure as long as air is supplied.

This can prevent the workpiece from being dropped.

② The unit turns on by instantaneous energizing (minimum 20 ms.). Continuous energizing is not necessary.

This can reduce the power consumption.

■ Linked supply and release valves operation

The self-holding type supply valve will be turned off by turning on the release valve. It is not necessary to send a signal to stop the vacuum, which simplifies the wiring and programming. (Current double solenoid and latching type require a signal to stop the vacuum.)

■ Power saving pilot valve

Supply and release valve are low power consumption type. (0.35 W)

Pressure sensor/switch

Variations

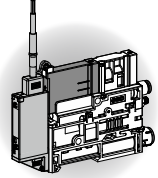

With digital pressure switch for vacuum with energy saving function

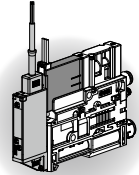

Digital pressure switch for vacuum

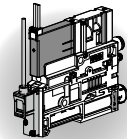

Pressure sensor

ZK2

ZQ

ZR

ZB

ZA

ZX

ZM

ZL

ZH

ZH

ZH-X267

ZHP

ZU

VQD-V

One-touch fitting

Air supply

Vacuum break flow adjusting needle

Vacuum

Suction filter

Silencer exhaust

Easier maintenance

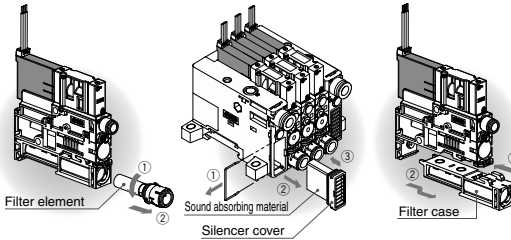

• Transparent filter case allows visual check of the contamination.

• Filter element and the sound absorbing material can be installed/removed without using screws.

• If there is dirt inside the case, it is possible to remove the case and clean it.

Digital pressure switch for vacuum*

■ Set value copy function:

Reduction in setting work/Prevention of mistakes in setting

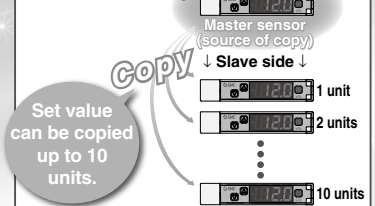

* Copy function is not available for switches with the energy saving function.

Mounting

■ Options

Single unit bracket mounting

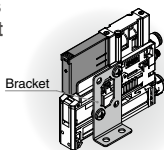

Single unit DIN rail mounting

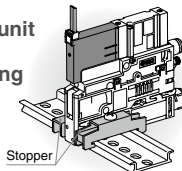

Manifold DIN rail mounting

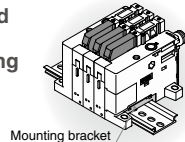

Vacuum Unit Variations

Single Unit Variations

Vacuum Ejector

Nozzle size

ø0.7, ø1.0, ø1.2, ø1.5

Air pressure supply (PV) port

ø6, ø1/4" One-touch fittings

Vacuum break flow adjusting needle

Round lock nut type (Option)



Screwdriver operation type (Option)



Vacuum (V) port

ø6, ø8 One-touch fittings
ø1/4", ø5/16" One-touch fittings

Vacuum switch

- Pressure sensor
- Pressure switch for vacuum
- Pressure switch for vacuum with energy saving function
- Without vacuum switch

Combination of supply valve and release valve

Supply valve	Release valve
N.C	N.C
N.C	None
Self-holding release valve linked	N.C
None	None

Supply valve/Release valve: Rated voltage
12, 24 VDC

With individual release pressure supply (PD) port*

PD port (M3)

*Option

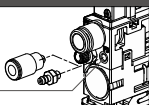

Vacuum Pump System

Vacuum pressure supply (PV) port

ø6, ø1/4" One-touch fittings

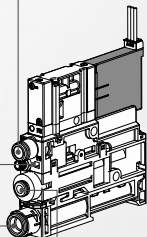

Pilot pressure supply (PS) port

ø4, ø5/16" One-touch fittings

Vacuum (V) port

ø6, ø8 One-touch fittings
ø1/4", ø5/16" One-touch fittings

Manifold Variations

Manifold stations

1 to 10 stations

Wiring type

- D-sub connector
- Flat ribbon cable
- Individual wiring

Exhaust type

- Complex exhaust^{Note)}
- Port exhaust
- High-noise reduction silencer exhaust

Air pressure supply (PV) port

ø8, ø5/16"

- Common supply
- Individual supply (Option)

Vacuum pressure (PV) port

ø8, ø5/16"

- Common supply

Individual wiring

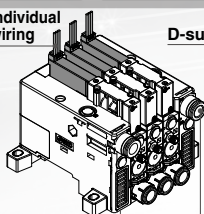

Complex exhaust^{Note)}

D-sub connector

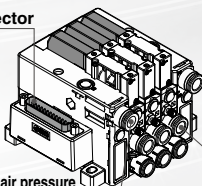

Individual port exhaust

Common air pressure supply (PV) port

Note) The complex exhaust is a combined exhaust method of the common exhaust from the end plate and the direct exhaust from each station.

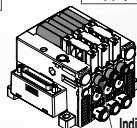

Individual air pressure supply (PV) port (Option)

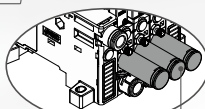

High-noise reduction silencer exhaust

Common pilot pressure supply (PS) port

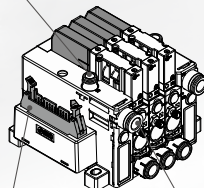

Flat ribbon cable connector

Common vacuum pressure supply (PV) port

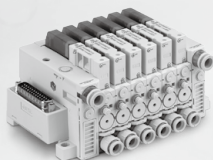

D-sub connector

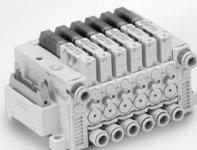

Flat ribbon cable

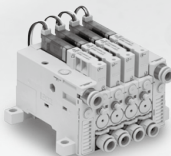

Individual wiring

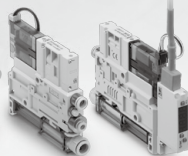

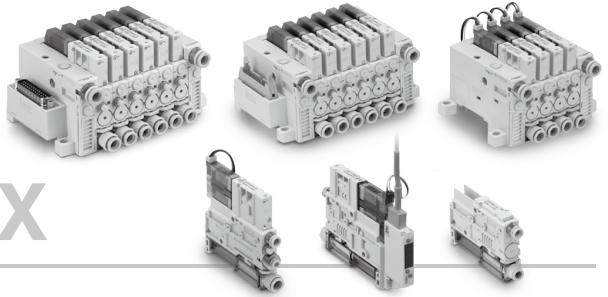

INDEX

How to Order

How to Order Single Unit.....	60, 62
How to Order Manifold.....	64

Specifications/Flow Rate Characteristics

Specifications, Weight.....	67
Exhaust Characteristics, Flow Rate Characteristics.....	68
Vacuum Pump System Flow Rate Characteristics, Vacuum Release Flow Rate Characteristics, How to Read Flow Rate Characteristics Graph.....	70
Pressure Sensor/Digital Pressure Switch for Vacuum Specifications.....	71
Digital Pressure Switch for Vacuum Specifications, Description, Internal Circuit and Wiring Example.....	72

Port Layout

Standard Products.....	73
Option -D.....	75
Option -L.....	78

Construction

Construction.....	80
Replacement Parts/How to Order.....	81

Exploded View of Manifold..... 82

Dimensions..... 84

Electrical Wiring Specifications, Optional Specifications/Functions/Applications.....	91
Cable Assembly.....	92

Specific Product Precautions..... 93

ZK2
ZQ
ZR
ZB
ZA
ZX
ZM
ZL
ZH
ZH
ZH-X267
ZHP
ZU
VQD-V

Vacuum Unit

ZK2 Series



Ejector System

How to Order Single Unit

Refer to page 64 for How to Order Manifold.

With Valve

ZK2 **A** **12** **K** **5** **A** **L** - **08** - □

Without Valve

ZK2 **A** **12** **N** **0** **N** **N** - **08** - □

① ② ③ ④ ⑤ ⑥ ⑦ ⑧

Remains blank when no option is selected.

① System/Body Type

Symbol	System	Body type	Exhaust type
A	Single unit	Single unit	Silencer exhaust
			Port exhaust <small>Note 1)</small>
			High-noise reduction silencer exhaust
G	Ejector system	Single unit	With silencer
			Complex exhaust <small>Note 2)</small>
F	For manifold	For manifold	Individual port exhaust <small>Note 1)</small>
H			High-noise reduction silencer exhaust <small>Note 1)</small>

Note 1) Port size of exhaust port: mm: ø8
inch: ø5/16"

Note 2) The complex exhaust is a combined exhaust method of the common exhaust from the end plate and the direct exhaust from each station.

② Nominal Nozzle Size

Symbol	System	Nominal size
07	Ejector system <small>Note 3)</small>	ø0.7
10		ø1.0
12		ø1.2
15		ø1.5

Note 3) Standard supply pressure for nozzle size 07 to 12 is 0.35 MPa, 15 is 0.4 MPa

④ Rated Voltage Note 7)

Symbol	Voltage
5	24 VDC
6	12 VDC
0	When ⑤ is "N"

Note 7) Rated voltage for the supply and release valve

③ Combination of Supply Valve and Release Valve Note 4)

Symbol	Supply valve	Release valve	
K	N.C.	N.C.	
J	N.C.	None	
R	Self-holding release valve linked <small>Note 5)</small>	N.C.	
N	None	None	

Note 4) Only non-locking type is available for the manual override for "K, J, R".

Note 5) Self-holding type maintains vacuum by instantaneous energization (20 ms or more). Stopping the vacuum turns on the release valve. (signal to stop vacuum not needed)

Note 6) When the digital pressure switch for vacuum with energy saving function is selected, select "K" for ⑤ Pressure Sensor/Digital Pressure Switch for Vacuum Specifications.

⑤ Pressure Sensor/Digital Pressure Switch for Vacuum Specifications

Symbol	Type	Pressure range (kPa)	Specifications	Pressure sensor
P	Pressure sensor	0 to -101	Analog output 1 to 5 V	
T		-100 to 100	Analog output 1 to 5 V	
A	Digital pressure switch for vacuum	0 to -101	NPN Unit selection function <small>Note 8)</small>	
B			SI unit only <small>Note 9)</small>	
C			PNP Unit selection function <small>Note 8)</small>	
D			SI unit only <small>Note 9)</small>	
E		-100 to 100	NPN Unit selection function <small>Note 8)</small>	
F			SI unit only <small>Note 9)</small>	
H			PNP Unit selection function <small>Note 8)</small>	
J			SI unit only <small>Note 9)</small>	
K	Digital pressure switch for vacuum with energy saving function <small>Note 10)</small>	-100 to 100	NPN Unit selection function <small>Note 8)</small>	
Q			SI unit only <small>Note 9)</small>	
S			PNP Unit selection function <small>Note 8)</small>	
N	Without pressure sensor/digital pressure switch for vacuum			

Note 8) Unit selection function is not available in Japan due to new measurement law.

Note 9) Fixed unit: kPa

Note 10) When "K, Q, R, S" is selected, select "K" for ③ Combination of Supply Valve and Release Valve. Select "W" or "L3" for ⑧.

- PV: Air pressure supply port/Port for vacuum source (Vacuum pump)
 - PS: Pilot pressure supply port
 - PD: Individual release pressure supply port
 - V: Vacuum port
 - EXH: Exhaust port
 - PE: Pilot pressure exhaust port
- For details => Page 79

6 Supply Valve/Release Valve/Digital Pressure Switch for Vacuum Connector Specifications

Symbol	3 For supply valve/release valve Connector type	Note 11 Lead wire with connector	5 Lead wire with connector for pressure switch/ sensor	Note 14		
C	Common wiring (Plug-in) (For manifold)	×	○ Note 15			
C1			×	Note 16		
L	L-type plug connector	○ Note 12	○ Note 15			
L1		×	Note 13	○ Note 15		
L2		○ Note 12	×	Note 16		
L3		×	Note 13	×	Note 16	
W		With lead wire for switch with energy saving function				
Y	Non-valve (without supply/ release valve) When "N" is selected for 3		○ Note 15			
Y1			×			
N	When "N" is selected for both 3 (Combination of Supply Valve and Release Valve) and 5 (Pressure Sensor/Digital Pressure Switch for Vacuum Specifications) (without supply/release valve, without switch, pressure sensor)					

7 Vacuum (V) Port Note 17

Symbol	Type	Port size	
06	Metric size	ø6	
08		ø8	
07	Inch size	ø1/4"	
09		ø5/16"	
		One-touch fitting	

Note 17) Supply port (PV) size of single unit:
 ø6 (mm), ø1/4" (inch)

- Note 11) Solenoid valve with light/surge voltage suppressor
 Note 12) Standard lead wire length for solenoid valve is 300 mm.
 Note 13) For lead wire lengths other than standard, select "L1 or L3", and order the connector assembly with desired length. (Refer to page 81.)
 Note 14) Standard lead wire length for pressure sensor is 3 m. Standard lead wire length with connector for pressure switch for vacuum and the lead wire length for switch with energy saving function is 2 m.
 Note 15) Select "C, L, L1, Y" when the pressure sensor (P, T) is selected for 5 Pressure Sensor/Digital Pressure Switch for Vacuum Specifications.
 Since only grommet type is available for the pressure sensor, sensor without lead wire cannot be selected.
 Note 16) Select when no pressure switch for vacuum, pressure sensor, or pressure switch for vacuum with connector without lead wire is used.

8 Optional Specifications Note 18

Symbol	Type	Symbol	Type
N11	Without option	L	Manifold individual supply specification <small>Note 20</small>
B	With one bracket for mounting a single unit (Mounting screw is attached)	P	Manifold common release pressure supply specification <small>Note 21</small>
D	With individual release pressure supply (PD) port <small>Note 19</small>	W	With exhaust interference prevention valve <small>Note 22, 23, 24, 25</small>
J	Vacuum break flow adjusting needle Round lock nut type		
K	Vacuum break flow adjusting needle Screwdriver operation type		

- Note 18) When more than one option is selected, list the option symbols in an alphabetical order.
 Example) -BJ
 Refer to page 91 for Function/Application.
 Note 19) Only M3 is available for PD port size. Use One-touch fitting (M-3AU-4) or barb fitting for piping. (O.D.: within ø6.2)
 Note 20) Select body for manifold. Select "L" for manifold type. When the common supply and individual supply are mixed, please contact SMC.
 Note 21) When "D" is selected for manifold option, select "-P" option for the single unit model number.
 Note 22) To prevent backflow of the manifold common exhaust, not for holding vacuum. This option does not completely stop the backflow of the exhaust air. Select port exhaust type depending on purpose.
 Note 23) When "J" is selected for 3 Combination of Supply Valve and Release Valve and "W" (with exhaust interference prevention valve) is selected for 8 Optional Specifications, install a release valve or vacuum breaker.
 Note 24) When "K, Q, R, S" is selected for 5 Pressure Sensor/Digital Pressure Switch for Vacuum Specifications, models with exhaust interference prevention valve is provided. So, it is not necessary to select "W".
 Note 25) For high-noise reduction silencer exhaust, "W" (With exhaust interference prevention valve) cannot be selected.
 Note 26) For 1 System/Body type "F" or "H," when "L" is selected for 8 Option, the vacuum break flow-adjusting needle option "K" or "JK" can be additionally selected for increased workability.

Single Unit and Options Note 27

1 System/ Body type	2 Nominal nozzle size	3 Combination of supply valve and release valve	4 Rated voltage	5 Pressure sensor/digital pressure switch for vacuum specifications	6 Supply valve/release valve/digital pressure switch for vacuum connector specifications	7 Vacuum (V) port	8 Optional specifications		
A/B/G	07 10 12 15	K	5 6	P/T	L/L1	06 08 07 09	B/D/J/K/W		
				A/B/C/D/E/F/H/J	L/L1/L2/L3		B/D/J/K		
				N	L2/L3				
		R	P/T	L/L1					
			A/B/C/D/E/F/H/J	L/L1/L2/L3	B/D/J/K/W				
			N	L2/L3					
C/F/H	07 10 12 15	J	0	P/T	L/L1	06 08 07 09	B/W		
				A/B/C/D/E/F/H/J	L/L1/L2/L3		B/W		
				N	L2/L3				
		K	5 6	R	0	P/T	Y/Y1	06 08 07 09	B/W
						A/B/C/D/E/F/H/J	N		B/W
						N	C/L/L1		
				J	A/B/C/D/E/F/H/J	C/C1/L/L1/L2/L3	J/K/L/P/W		
					N	C1/L2/L3	J/K/L/P		
					K/Q/R/S	L3/W	J/K/L/P		
R	5 6	J	0	P/T	C/L/L1	06 08 07 09	J/K/L/P/W		
				A/B/C/D/E/F/H/J	C/C1/L/L1/L2/L3		J/K/L/P/W		
				N	C1/L2/L3				
N	0	J	0	P/T	C/L/L1	06 08 07 09	L/W		
				A/B/C/D/E/F/H/J	C/C1/L/L1/L2/L3		L/W		
				N	C1/L2/L3				
N	0	J	0	P/T	Y	06 08 07 09	L/W		
				A/B/C/D/E/F/H/J	Y/Y1		L/W		
				N	N				

Note 27) When "J" is selected for 3 Combination of Supply Valve and Release Valve, "J" or "K" cannot be selected for 8 Optional Specifications.
 For options not in the table, please contact SMC.
 *Refer to page 97 when mounting a single unit onto the DIN rail.

Vacuum Unit

ZK2 Series

Vacuum Pump System



How to Order Single Unit

Refer to page 64 for How to Order Manifold.

Vacuum Pump System

ZK2 **P** 00 **K** **5** **A** **L** - **08** -

1
 2 3 4 5
 6
 7

Remains blank when no option is selected.

1 System/Body Type

Symbol	System	Body type	Exhaust type	Note 1)
P	Vacuum pump system	Single unit	—	
		For manifold	—	

Note 1) PS port size of pump system: mm: $\phi 4$
inch: $\phi 5/32$ "

2 Combination of Supply Valve and Release Valve ^{Note 2)}

Symbol	Supply valve	Release valve	^{Note 2)} Supply valve Release valve
K	N.C.	N.C.	
J	N.C. ^{Note 3)}	None	
R	Self-holding release valve linked ^{Note 4)}	N.C.	

Note 2) Only non-locking type is available for the manual override for "K, J, R".
 Note 3) When "J" is selected for vacuum pump system, install a release valve or vacuum breaker.
 Note 4) Self-holding type maintains vacuum by instantaneous energization (20 ms or more). Stopping the vacuum turns on the release valve. (signal to stop vacuum not needed)

3 Rated Voltage ^{Note 5)}

Symbol	Voltage
5	24 VDC
6	12 VDC

Note 5) Rated voltage for the supply and release valve

4 Pressure Sensor/Digital Pressure Switch for Vacuum Specifications

Symbol	Type	Pressure range [kPa]	Specifications	Pressure sensor
P	Pressure sensor	0 to -101	Analog output 1 to 5 V	
T		-100 to 100	Analog output 1 to 5 V	
A	Digital pressure switch for vacuum	0 to -101	NPN 2 outputs Unit selection function ^{Note 6)}	
B			SI unit only ^{Note 7)}	
C			PNP 2 outputs Unit selection function ^{Note 6)}	
D			SI unit only ^{Note 7)}	
E			NPN 2 outputs Unit selection function ^{Note 6)}	
F			SI unit only ^{Note 7)}	
H	-100 to 100		PNP 2 outputs Unit selection function ^{Note 6)}	
J			SI unit only ^{Note 7)}	
N	Without pressure sensor/ Digital pressure switch for vacuum			

Note 6) Unit selection function is not available in Japan due to new measurement law.
 Note 7) Fixed unit: kPa

- PV: Air pressure supply port/Port for vacuum source (Vacuum pump)
 - PS: Pilot pressure supply port
 - PD: Individual release pressure supply port
 - V: Vacuum port
 - EXH: Exhaust port
 - PE: Pilot pressure exhaust port
- For details ⇒ Page 79

5 Supply Valve/Release Valve/Digital Pressure Switch for Vacuum Connector Specifications

Symbol	② For supply valve/release valve <small>Note 8)</small>		④ Lead wire with connector for pressure switch/sensor <small>Note 11)</small>	Image
	Connector type	Lead wire with connector		
C	Common wiring (Plug-in) (For manifold)	×	○ <small>Note 12)</small>	
C1			×	×
L	L-type plug connector	○ <small>Note 9)</small>	○ <small>Note 12)</small>	
L1		×	○ <small>Note 12)</small>	
L2		○ <small>Note 9)</small>	×	
L3		×	×	

- Note 8) Solenoid valve with light/surge voltage suppressor
 Note 9) Standard lead wire length for solenoid valve is 300 mm.
 Note 10) For lead wire lengths other than standard, select "L1" or L3", and order the connector assembly with desired length. (Refer to page 81.)
 Note 11) Standard lead wire length for pressure sensor is 3 m. Standard lead wire length with connector for switch for vacuum and the lead wire length for switch with energy saving function is 2 m.
 Note 12) Select "C, L, L1" when the pressure sensor (P, T) is selected for ④ Pressure Sensor/Digital Pressure Switch for Vacuum Specifications. Since only grommet type is available for the pressure sensor, sensor without lead wire cannot be selected.
 Note 13) Select when no pressure switch for vacuum, pressure sensor, or pressure switch for vacuum with connector without lead wire is used.

6 Vacuum (V) Port Note 14)

Symbol	Type	Port size	
06	Metric size	ø6	
08		ø8	
07	Inch size	ø1/4"	
		ø5/16"	

Note 14) Supply port (PV) size of single unit: ø6 (mm), ø1/4" (inch)

- ZK2
- ZQ
- ZR
- ZB
- ZA
- ZX
- ZM
- ZL
- ZH
- ZH
- ZH-X267
- ZHP
- ZU
- VQD-V

7 Optional Specifications Note 15, 18)

Symbol	Type	Symbol	Type
Nil	Without option	J	Vacuum break flow adjusting needle Round lock nut type
B	With one bracket for mounting a single unit (Mounting screw is attached.)		K
C	Pump system PE port female thread specification(M3) <small>Note 15)</small>	P	
D	With individual release pressure supply (PD) port <small>Note 16)</small>		

- Note 15) When more than one option is selected, list the option symbols in an alphabetical order. Example) -BJ
 Note 16) Only M3 is available for PD port size. Use One-touch fitting (M-3AU-4) or barb fitting for piping. (O.D.: within ø6.2)
 Note 17) When "-D" is selected for manifold option, select "-P" option for the single unit model number.
 Note 18) Refer to page 91 for Function/Application.
 Note 19) Use One-touch fitting (M-3AU-4) or barb fitting for piping. (O.D.: within ø5.8)

Single Unit and Options Note 19)

① System/Body type	Vacuum pump system part number	② Combination of supply valve and release valve	③ Rated voltage	④ Pressure sensor/digital pressure switch for vacuum specifications	⑤ Supply valve/release valve/digital pressure switch for vacuum connector specifications	⑥ Vacuum (V) port	⑦ Optional specifications	
P	00	K/R	5 6	P/T	L/L1	06 08 07 09	B/C/D/J/K	
				A/B/C/D/E/F/H/J	L/L1/L2/L3			
		N		L2/L3				
		P/T		L/L1				
Q	00	J		A/B/C/D/E/F/H/J	L/L1/L2/L3		B/C	
				N	L2/L3			
		K/R		A/B/C/D/E/F/H/J	C/C1/L/L1/L2/L3			C/J/K/P
				N	C1/L2/L3			
Q	00	J	P/T	C/L/L1	C			
			A/B/C/D/E/F/H/J	C/C1/L/L1/L2/L3				
		K/R	N	C1/L2/L3				
			P/T	C/L/L1				

- Note 19) When "J" is selected for ② Combination of Supply Valve and Release Valve, "J or K" cannot be selected for ⑦ Optional Specifications.
 For options not in the table, please contact SMC.
 *Refer to page 97 when mounting a single unit onto the DIN rail.

How to Order Manifold

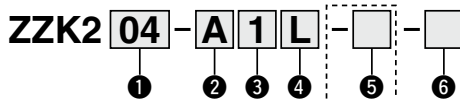

Remains blank when no option is selected.

1 Stations Note 1)

Symbol	Stations
01	1 station
02	2 stations
⋮	⋮
10	10 stations

Note 1) In the case of an ejector, for an adequate performance, the number of stations when operated simultaneously depends on the nozzle diameter. (Refer to Maximum Number of Manifold Stations that Can Operate Simultaneously on page 67.)

2 System (Port combination) Note 2)

Symbol	System	Port	Standard
P	Vacuum pump system	Common PV: $\phi 8$, Common PS: $\phi 6$	Metric size
A	Ejector system	Common PV: $\phi 8$	
PN	Vacuum pump system	Common PV: $\phi 5/16"$, Common PS: $\phi 1/4"$	Inch size
AN	Ejector system	Common PV: $\phi 5/16"$	

Note 2) Refer to pages 73 to 79 for the port layout of standard port combinations and options.

Note 3) Common PS port and common PD port are connected inside. Connect One-touch fitting to one of ports so that piping becomes easier. (Connected to PS port initially)

Note 4) Common PV = Common PS = Common PD. Pressure is equal.

3 Exhaust

Symbol	Exhaust type	
2	Vacuum pump system	Without silencer
1	Ejector system	Complex exhaust <small>Note 7)</small> <small>Note 5)</small> (End plate on both sides)
		Individual exhaust (Individual port exhaust, High-noise reduction silencer exhaust) <small>Note 6)</small>

Note 5) Select "C" for 1 System/Body Type for the single unit model number.

Air is exhausted not only from the end plate, but also from the exhaust of each station.

Note 6) Select "F" or "H" for 1 System/Body Type for the single unit model number.

Note 7) The complex exhaust is a combined exhaust method of the common exhaust from the end plate and the direct exhaust from each station.

4 Wiring Note 8)

Symbol	Type
L	Individual wiring specification <small>Note 9)</small>
F	D-sub connector <small>Note 10)</small> (25 pins)
P	Flat ribbon cable <small>Note 10)</small> (26 pins)
N	No wiring (No valve)

Note 8) Common wiring is available only for solenoid valve wiring. Individual wiring is specified for vacuum switches and sensors.

Note 9) Select "L, L□, or W" for 6 Supply Valve/Release Valve/Digital Pressure Switch for Connector Specifications for the single unit model number.

Note 10) Select "C, C1" for 6 Supply Valve/Release Valve/Digital Pressure Switch for Connector Specifications for the single unit model number.

5 Option Note 11)

Symbol	Type
Nil	Without option
B	With DIN rail mounting bracket <small>Note 12)</small>
D	With common release pressure supply (PD) port <small>Note 13)</small>
L	Manifold individual supply specification <small>Note 14)</small>

Note 11) When more than one option is selected, list the option symbols in an alphabetical order.

Example) -BD

Note 12) DIN rail should be ordered separately. (Refer to page 82.)

Note 13) When "-D" is selected for the manifold model number, select "-P" for ③ Optional Specifications for the ejector system single unit model number and ⑦ Optional Specifications for the vacuum pump system single unit model number. Refer to pages 73 to 79 for port layout.

Note 14) When "-L (individual supply)" is selected for ③ Optional Specifications for the single unit model number, specify "-L" for manifold, too.

6 Manifold Assembly (Delivery condition)

Symbol	Type
Nil	Individual units assembled delivered as a manifold
A	Delivered as individual parts (not assembled) <small>Note 15)</small>

Note 15) Kit consists of end plates for both ends and tension bolts.

Manifold parts when not assembled

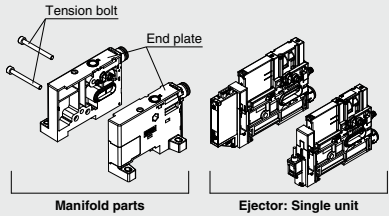

ZZK202-A1L-A.....1 set (Manifold part number)
 ZK2C10K5BL3-08.....1 set (Single unit part number)
 ZK2C10K5PL1-08.....1 set (Single unit part number)
 ↳ Do not add "s"

Manifold Type and Options

	1	2	3	4	5	6
ZK2K	01	P	2	L	•	Nil
	10	PN	2	FF	•	
	A		1	L	•	A
	AN		2	FF	•	

How to Order Valve Manifold Assembly

Example

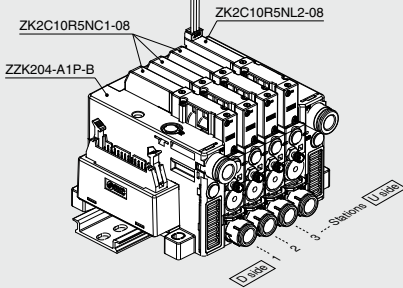

ZZK204-A1P-B.....1 set (Manifold part number)
 * ZK2C10R5NC1-08.....3 sets (Common wiring specification)
 * ZK2C10R5NL2-08.....1 set (Individual wiring specification)
 ↳ * The asterisk denotes the symbol for assembly.
 ↳ * Prefix to the single unit part number.

- When the manifold is viewed from V port, the first station starts from the left (D side).
- After the manifold part number, specify the installed single unit from the first station.
- Complex exhaust and individual port exhaust cannot be mixed in the ejector system manifold.
- DIN rail should be ordered separately. (Page 82)

ZK2

ZQ

ZR

ZB

ZA

ZX

ZM

ZL

ZH

ZH

ZH

-X267

ZHP

ZU

VQD-V

Specifications

General Specifications

Operating temperature range		-5 to 50°C (with no condensation)
Fluid		Air
Vibration resistance	Note 1) 30 m/s ²	Without pressure sensor/switch for vacuum With pressure sensor
	20 m/s ²	With switch for vacuum
Impact resistance	Note 2) 150 m/s ²	Without pressure sensor/switch for vacuum With pressure sensor
	100 m/s ²	With switch for vacuum

Note 1) The characteristics are satisfied when tested for 2 hours in each of the X, Y and Z directions at 10 to 500 Hz without energization. (Initial value)

Note 2) The characteristics are satisfied when tested one time in each of the X, Y and Z directions without energization. (Initial value)

Valve Common Specifications

Valve model ^{Note 3)}	ZK2-VA□R	ZK2-VA□K	ZK2-VA□J
Type of actuation ^{Note 4)}	Self-holding supply valve Release valve N.C. (Linked)	Supply valve N.C. Release valve N.C.	Supply valve N.C. Without release valve
Valve configuration	Pilot operated dual 2 port		Pilot operated 2 port
Operating pressure range	0.3 to 0.6 MPa		
Valve construction	Poppet seal		
Manual override	Push type		
Rated voltage	24 VDC, 12 VDC		
Power consumption	0.35 W		
Lead wire (ZK2-LV***A)	Cross section: 0.2 mm ² (AWG24)		
	Insulator O.D.: 1.4 mm		

Note 3) Refer to ⑥ Valve assembly on page 81 for the valve model number.

Note 4) ZK2-VA□R: After instantaneous energization of the supply valve (20 ms or more), ON state is maintained without energization. Supply valve turns off simultaneously when the release valve turns on.

ZK2-VA□K: Supply valve turns off when is not energized. Select this type when energy saving switch is used.

Ejector Specifications

Item		Model	ZK2□07	ZK2□10	ZK2□12	ZK2□15
Nozzle diameter		[mm]	0.7	1.0	1.2	1.5
Max. suction flow ^{Note 5)}	Port exhaust	[L/min (ANR)]	34	56	74	89
	Silencer exhaust/Complex exhaust	[L/min (ANR)]	29	44	61	67
	High-noise reduction silencer exhaust	[L/min (ANR)]	34	56	72	83
Air consumption ^{Note 5)}		[L/min (ANR)]	24	40	58	90
Maximum vacuum pressure ^{Note 5)}		[kPa]	-91			
Supply pressure range		[MPa]	0.3 to 0.6			
Standard supply pressure ^{Note 6)}		[MPa]	0.35		0.4 (0.37)	

Note 5) Values at the standard supply pressure. Values are based on standard of SMC measurements. They depend on atmospheric pressure (weather, altitude, etc.) and measurement method.

Note 6) The value in () is for without valve. For nozzle size 07 to 12, the value is common to the ejectors with valve and without valve.

Maximum Number of Manifold Stations that Can Operate Simultaneously^{Note 7)}

Item		Model (Nozzle size)	ZK2□07	ZK2□10	ZK2□12	ZK2□15
Air pressure supply (PV) port ø8, ø5/16"	Complex exhaust	Supply from one side	8	5	4	3
		Supply from both sides	10	7	5	5
	Individual port exhaust, High-noise reduction silencer exhaust	Supply from one side	8	6	6	3
		Supply from both sides	10	9	9	6

Note 7) As long as the number of stations operated simultaneously is the value on the table or less, then the manifold is available up to 10 stations.

Noise level (Reference values)

Item		Model	ZK2□07	ZK2□10	ZK2□12	ZK2□15
Noise level [dB(A)]	ZK2G (High-noise reduction silencer exhaust)		46	55	63	69
	ZK2A (Silencer exhaust)		59	66	75	76

Actual values based on SMC's measurement conditions (Not guaranteed values)

Weight

Single Unit

Single unit model	Weight [g]
ZK2P00K□□ (Vacuum pump system, Single unit, Without pressure sensor/switch for vacuum)	83
ZK2A□□K□□ (Ejector system, Single unit, Without pressure sensor/switch for vacuum)	81
ZK2A□□NONN (Ejector system, Single unit, Without valve)	54
ZK2 (One station for manifold, Without pressure sensor/switch for vacuum)	85

Pressure Sensor/Pressure Switch for Vacuum

Pressure sensor/Pressure switch for vacuum model	Weight [g]
ZK2-PS□-A (Except cable portion)	5
ZK2-ZS□-A (Except lead wire assembly with connector)	14
ZK2-ZSV□-A (Except special lead wire assembly with connector)	

Manifold Base

	1 station	2 stations	3 stations	4 stations	5 stations	6 stations	7 stations	8 stations	9 stations	10 stations
Weight [g]	129	132	135	138	141	144	147	149	152	155

● Calculation of Weight for the Manifold Type

(Single unit weight x Number of stations) + (Pressure sensor/Pressure switch for vacuum weight x Number of stations) + Manifold base

Example) 5-station manifold with pressure sensors 85 g x 5 pcs. + 5 g x 5 pcs. + 141 g = 591 g

ZK2 Series

Ejector Exhaust Characteristics/Flow Rate Characteristics (Representative value)

*The flow rate characteristics correspond to the standard supply pressure.

ZK2□07

Exhaust Characteristics

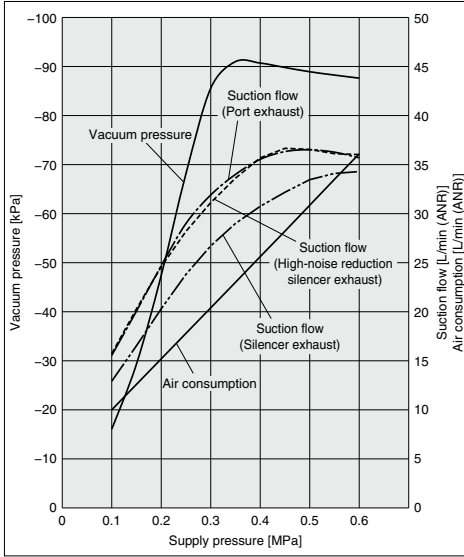

Flow Rate Characteristics

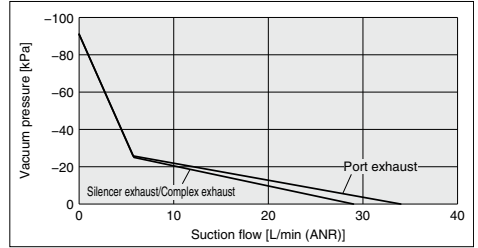

Flow Rate Characteristics

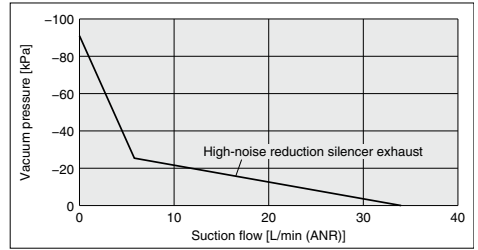

ZK2□10

Exhaust Characteristics

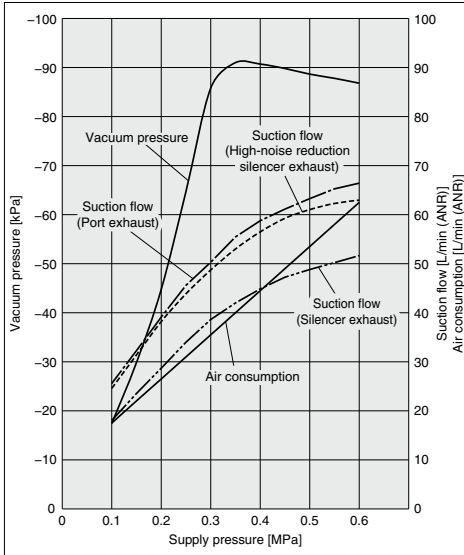

Flow Rate Characteristics

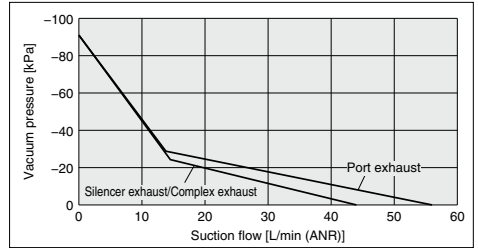

Flow Rate Characteristics

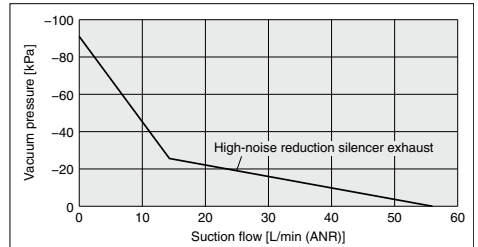

Ejector Exhaust Characteristics/Flow Rate Characteristics (Representative value)

*The flow rate characteristics correspond to the standard supply pressure.

ZK2□12

Exhaust Characteristics

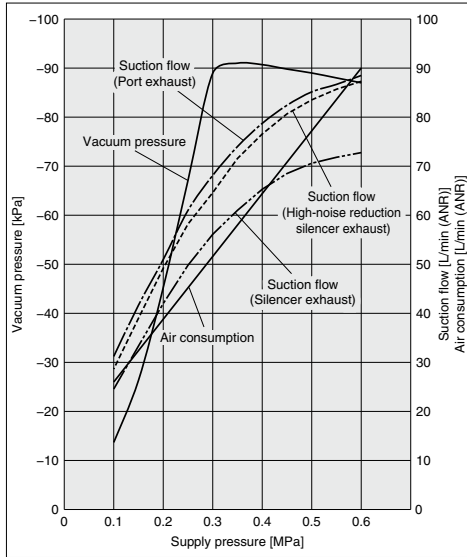

Flow Rate Characteristics

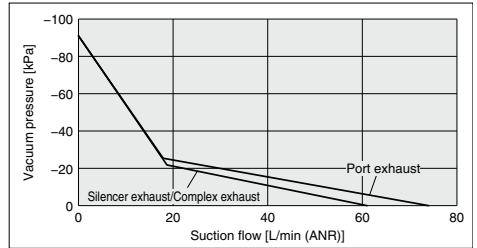

Flow Rate Characteristics

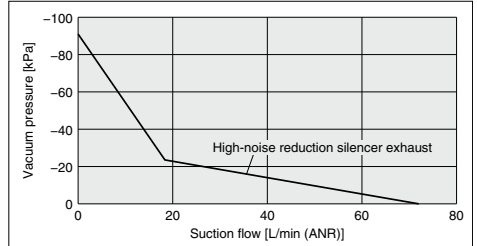

ZK2□15 Note 8) The following graphs show the characteristics of the ejector with valve. (Please contact SMC for models without valve.)

Exhaust Characteristics

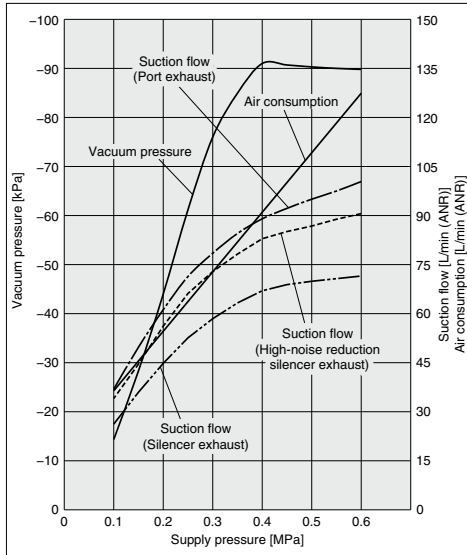

Flow Rate Characteristics

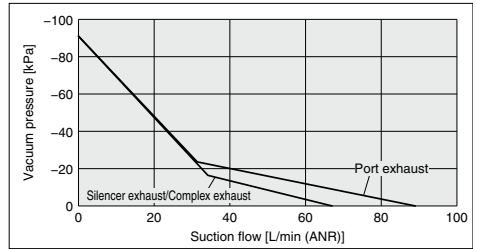

Flow Rate Characteristics

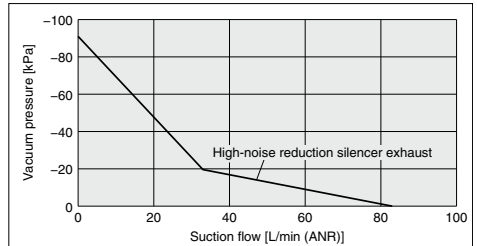

- ZK2
- ZQ
- ZR
- ZB
- ZA
- ZX
- ZM
- ZL
- ZH
- ZH-X267
- ZHP
- ZU
- VQD-V

ZK2 Series

Vacuum Pump System Flow Rate Characteristics/ZK2P00

The graph shows the suction flow rate characteristics of the vacuum pump system at different vacuum pressures.

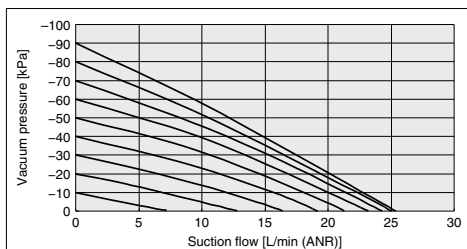

The actual suction flow at the point of suction varies depending on the piping conditions to the vacuum port. (The above graph shows the value when V port is ø8.)

Vacuum Release Flow Rate Characteristics

The graph shows the flow rate characteristics at different supply pressures when the vacuum break flow adjusting needle is open from the fully closed state.

ZK2□□□(Ejector System)

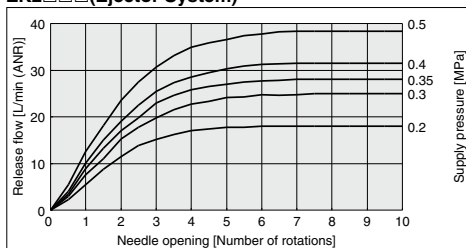

The actual suction flow at the point of suction varies depending on the piping conditions to the vacuum port. (The above graph shows the value of the ZK2B07.)

ZK2□□□(Pump System)

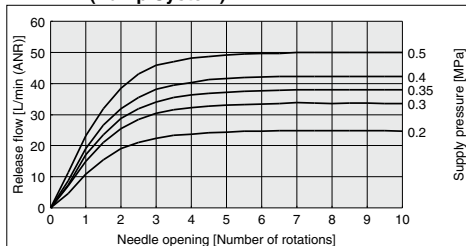

The actual suction flow at the point of suction varies depending on the piping conditions to the vacuum port.

Vacuum Pump System Flow Rate Characteristics of Flow Path and Vacuum Release

Port size		Flow rate characteristics of V → PV (Vacuum side)			Flow rate characteristics of PS → V (Vacuum release side) ^(*)		
PV port	V port	C[dm ³ /(s·bar)]	b	Cv	C[dm ³ /(s·bar)]	b	Cv
ø6	ø8	0.39	0.14	0.09	0.20	0.06	0.04

(*) When needle is fully open

How to Read Flow Rate Characteristics Graph

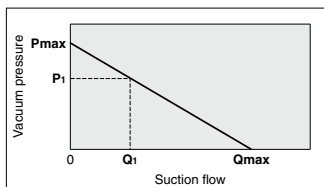

Flow rate characteristics are expressed in ejector vacuum pressure and suction flow. If suction flow changes, the vacuum pressure will also be changed. Normally this relationship is expressed in ejector standard operating pressure use. In graph, **Pmax** is maximum vacuum pressure and **Qmax** is maximum suction flow. The values are specified according to catalog use. Changes in vacuum pressure are expressed in the below order.

1. When ejector suction port is covered and made airtight, suction flow becomes zero and vacuum pressure is at maximum value (**Pmax**).
2. When suction port is opened gradually, air can flow through, (air leakage), suction flow increases, but vacuum pressure decreases. (condition **P1** and **Q1**)
3. When suction port is opened further and fully opened, suction flow moves to maximum value (**Qmax**), but vacuum pressure is near zero (atmospheric pressure).

As described above, the vacuum pressure changes when the suction flow changes. In other words, when there is no leakage from the vacuum (V) port, the vacuum pressure can reach its maximum, but as the amount of leakage increases, the vacuum pressure decreases. When the amount of leakage and the maximum suction flow become equal, the vacuum pressure becomes almost zero. In the case when ventilative or leaky work should be adsorbed, take note that vacuum pressure will not rise.

Pressure Sensor/Digital Pressure Switch for Vacuum Specifications

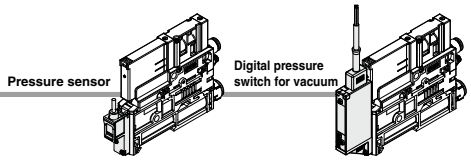

Pressure Sensor/ZK2-PS□-A (For details, refer to the PSE series in the Best Pneumatics No. 8 catalog, and the Operation Manual.)

Model (Sensor unit: Standard model number)	ZK2-PS1-A (PSE541)	ZK2-PS3-A (PSE543)
Rated pressure range	0 to -101 kPa	-100 to 100 kPa
Proof pressure	500 kPa	
Applicable fluid	Air/Non-corrosive gas/Incombustible gas	
Output voltage	1 to 5 VDC	
Output impedance	Approx. 1 kΩ	
Power supply voltage	10 to 24 VDC ±10%, Ripple (P-P) 10% or less	
Current consumption	15 mA or less	
Accuracy	±2% F.S. (Ambient temperature at 25°C)	
Linearity	±0.4% F.S. or less	
Repeatability	±0.2% F.S. or less	
Effect of power supply voltage	±0.8% F.S. or less	
Temperature characteristics	±2% F.S. or less (Ambient temperature: 25°C reference)	
Material	Case	Resin case
	Pressure sensing section	Sensor pressure receiving area: Silicon, O-ring: HNBR
Lead wire	Oilproof heavy-duty cable 2.7 x 3.2 mm (Elliptic), 0.15 mm ² 3 cores 3 m	

Digital Pressure Switch for Vacuum/ZK2-ZS□□□□-A

(For details, refer to the ZSE/ISE10 series in the Best Pneumatics No. 8 catalog, and the Operation Manual.)

Model (Switch unit: Standard model number)	ZK2-ZSE□□□-A (ZSE10)	ZK2-ZSF□□□-A (ZSE10F)
Rated pressure range	0 to -101 kPa	-100 to 100 kPa
Set pressure range/Pressure display range	10 to -105 kPa	-105 to 105 kPa
Proof pressure	500 kPa	
Smallest settable increment	0.1 kPa	
Applicable fluid	Air/Non-corrosive gas/Incombustible gas	
Power supply voltage	12 to 24 VDC ±10%, Ripple (p-p) 10% or less (Protected against reverse connection)	
Current consumption	40 mA or less	
Switch output	NPN or PNP open collector 2 outputs (selectable)	
	Maximum load current	80 mA
	Maximum applied voltage	28 V (with NPN output)
	Residual voltage	2 V or less (with load current at 80 mA)
	Response time	2.5 ms or less (Anti-chattering function working: 20, 100, 500, 1000 or 2000 ms selected)
Short circuit protection	Yes	
Repeatability	±0.2% F.S. ±1 digit	
Hysteresis	Hysteresis mode	Variable (0 or above) ^{Note)}
	Window comparator mode	
Display	3 1/2 digit, 7-segment LED, 1-color display (Red)	
Display accuracy	±2% F.S. ±1 digit (Ambient temperature at 25 ±3°C)	
Indicator light	Lights up when output is turned ON, OUT1: Green, OUT2: Red	
Environmental resistance	Enclosure	IP40
	Operating temperature range	Operating: -5 to 50°C, Storage: -10 to 60°C (with no freezing or condensation)
	Operating humidity range	Operating/Storage: 35 to 85% RH (with no condensation)
	Withstand voltage	1000 VAC for 1 minute between terminals and housing
Insulation resistance	50 MΩ or more (500 VDC measured via megohmmeter) between terminals and housing	
Temperature characteristics	±2% F.S. (at 25°C in an operating temperature range of -5 and 50°C)	
Lead wire	Oilproof heavy-duty vinyl cable 5 cores, Cross section: 0.15 mm ² (AWG26), Insulator O.D.: 1.0 mm	
Standards	Compliant with CE marking, RoHS	

Note) If the applied pressure fluctuates around the set value, the hysteresis must be set to a value more than the fluctuating width, otherwise, chattering will occur.

ZK2

ZQ

ZR

ZB

ZA

ZX

ZM

ZL

ZH

ZH

ZH

ZHP

ZU

VQD-V

ZK2 Series

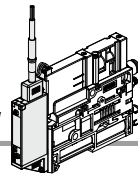

Digital pressure switch for vacuum with energy saving function

Digital Pressure Switch for Vacuum Specifications

Digital Pressure Switch for Vacuum Ejector with Energy Saving Function

Model		Specifications
Rated pressure range		-100 to 100 kPa
Set pressure range		-105 to 105 kPa
Proof pressure		500 kPa
Smallest settable increment		0.1 kPa
Applicable fluid		Air/Non-corrosive gas/Incombustible gas
Power supply voltage		12 to 24 VDC $\pm 10\%$ Ripple (P-P) 10% or less (Protected against reverse connection)
Current consumption		40 mA or less
Switch output		NPN or PNP open collector OOUT1: General purpose, OOUT2: Valve control
Maximum load current		80 mA
Maximum applied voltage		26.4 VDC
Residual voltage		2 V or less (with load current at 80 mA)
Response time		2.5 ms or less (Anti-chattering function working: 20, 100, 500, 1000 or 2000 ms selected)
Short circuit protection		Yes
Repeatability		$\pm 0.2\%$ F.S. ± 1 digit
Hysteresis		Variable (0 or above) ^{Note)}
Display		3 1/2 digit, 7-segment LED, 1-color display (Red)
Display accuracy		$\pm 2\%$ F.S. ± 1 digit (Ambient temperature at 25 $\pm 3^\circ\text{C}$)
Indicator light		Lights up when output is turned ON. OOUT1: Green, OOUT2: Red
Environmental resistance		Enclosure IP40
Operating humidity range		5 to 50°C
Withstand voltage		1000 VAC for 1 minute between terminals and housing
Insulation resistance		50 M Ω or more (500 VDC measured via megohmmeter) between terminals and housing
Temperature characteristics		$\pm 2\%$ F.S. (at 25°C in an operating temperature range of 5 and 50°C)
Lead wire		Cable: 5 cores $\phi 3.5$, 2 m Cross section: 0.15 mm ² (AWG26) Insulator O.D.: 1.0 mm
Standards		CE marking, RoHS

Note) If the applied pressure fluctuates around the set value, the hysteresis must be set to a value more than the fluctuating width, otherwise, chattering will occur.

Description (Pressure Switch for Vacuum)

Output (OOUT1) display (Green)	Lights up when OOUT1 is turned ON.
Output (OOUT2) display (Red)	Lights up when OOUT2 is turned ON.
LED display	Displays the current pressure, set mode and error code.
button (UP)	Selects the mode or increases the ON/OFF set-value. Use for switching to the peak display mode.
button (DOWN)	Selects the mode or decreases the ON/OFF set-value. Use for switching to the bottom display mode.
button (SET)	Use for changing the mode or setting the set-value.

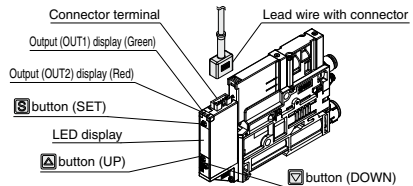

Internal Circuit and Wiring Example

■ Pressure Sensor ZK2-PS□□-A

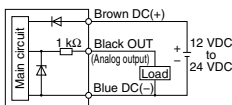

Voltage output type: 1 to 5 V
Output impedance: Approx. 1 k Ω

■ Pressure Switch for Vacuum ZK2-ZS□□□□-A NPN (2 Outputs)

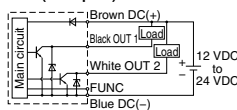

Max. 28 V, 80 mA
Residual voltage: 2 V or less

ZK2-ZS□□□□-A PNP (2 Outputs)

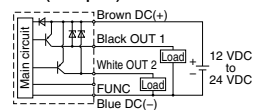

Max. 80 mA
Residual voltage: 2 V or less

*The FUNC terminal is connected when using the copy function. (Refer to the Operation Manual.)

■ Pressure Switch for Vacuum with Energy Saving Function ZK2-ZSVA□□□□-A NPN (Output)

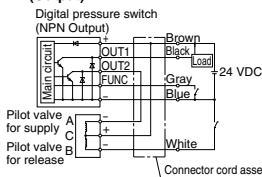

ZK2-ZSVB□□□□-A PNP (Output)

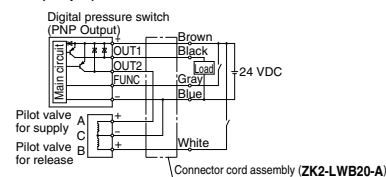

Port Layout

*System depends on vacuum source (vacuum pump/vacuum ejector).

Standard Products

Port layout No. 1

Single unit: ZK2P00□□□□-□

System	Vacuum pump
Body type	Single unit
Exhaust type	Without silencer
Application and purpose	Vacuum pressure — Exhaust — Release pressure Same pressure as PS

Port combination: PV ≠ PS = PD **Circuit example**

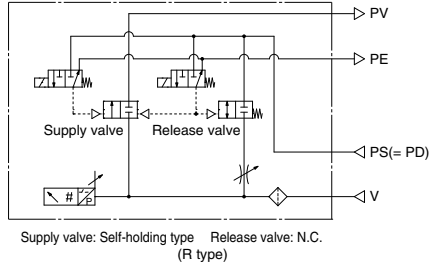

ZK2
ZQ
ZR
ZB
ZA
ZX
ZM
ZL
ZH

Port layout No. 2

Single unit: ZK2Q00□□□□-□
Manifold: ZK2□□-P2□

System	Vacuum pump
Body type	Manifold
Exhaust type	Without silencer
Application and purpose	Vacuum pressure Common for each station Exhaust — Release pressure Same pressure as common PS

Port combination: Common PV ≠ Common PS = Common PD **Circuit example**

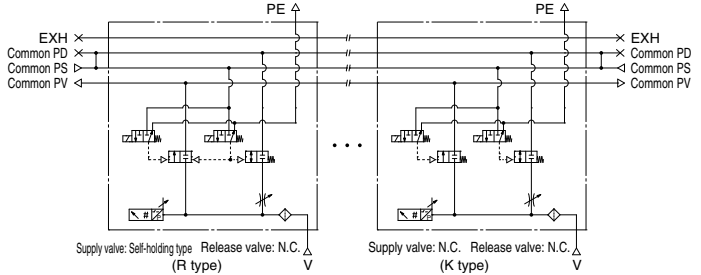

ZH
ZH
ZH
X267
ZHP
ZU
VQD-V

Port layout No. 3

Single unit: ZK2A□□□□□□-□

System	Ejector
Body type	Single unit
Exhaust type	Silencer exhaust
Application and purpose	Vacuum pressure — Exhaust Released in operating environment Release pressure Same pressure as PV

Port combination: PV = PS = PD **Circuit example**

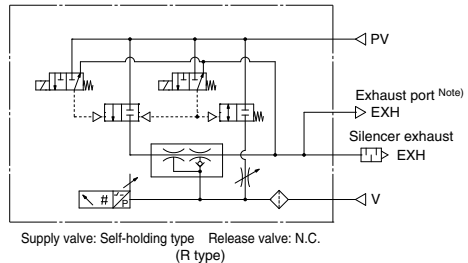

Refer to page 79 for the purpose of port and the operating pressure range.

ZK2 Series

Port Layout

*System depends on vacuum source (vacuum pump/vacuum ejector).

Standard Products

Port layout No. 4

Single unit: ZK2B□□□□□□□□

System	Ejector
Body type	Single unit
Exhaust type	Port exhaust
Application and purpose	Vacuum pressure — Exhaust After piping, individual exhaust is necessary Release pressure Same pressure as PV

Port combination: PV = PS = PD **Circuit example**

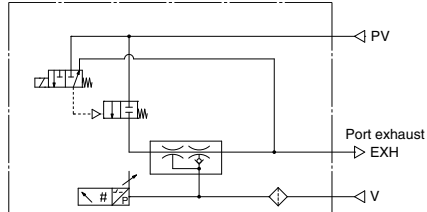

Supply valve: N.C. Release valve: Without release valve (J type)

Port layout No. 5

Single unit: ZK2G□□□□□□□□

System	Ejector
Body type	Single unit
Exhaust type	High-noise reduction silencer exhaust
Application and purpose	Vacuum pressure — Exhaust Released in operating environment Release pressure Same pressure as PV

Port combination: PV (= PS = PD) **Circuit example**

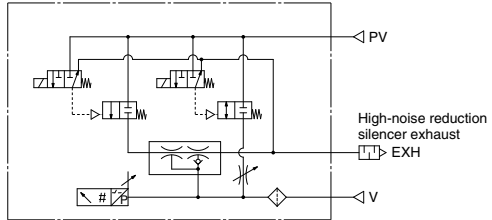

Supply valve: N.C. Release valve: N.C. (K type)

Port layout No. 6

Single unit: ZK2C□□□□□□□□
Manifold: ZZK2□□□-A1□

Note) The complex exhaust is a combined exhaust method of the common exhaust from the end plate and the direct exhaust from each station.

System	Ejector
Body type	Manifold
Exhaust type	Complex exhaust ^{Note)}
Application and purpose	Vacuum pressure Common for each station Exhaust Released in operating environment Release pressure Same pressure as common PV

Port combination: Common PV = Common PS = Common PD **Circuit example**

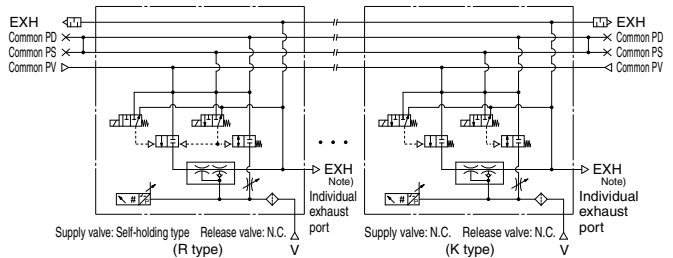

Refer to page 79 for the purpose of port and the operating pressure range.

Port Layout

*System depends on vacuum source (vacuum pump/vacuum ejector).

Standard Products

Port layout No. 7

Single unit: ZK2F□□□□□-□
Manifold: ZZK2□□-A2□

System	Ejector
Body type	Manifold
Exhaust type	Individual port exhaust
Application and purpose	Common for each station
Vacuum pressure	Common for each station
Exhaust	After piping, individual exhaust is necessary.
Release pressure	Same pressure as common PV

Port combination: Common PV = Common PS = Common PD

Circuit example

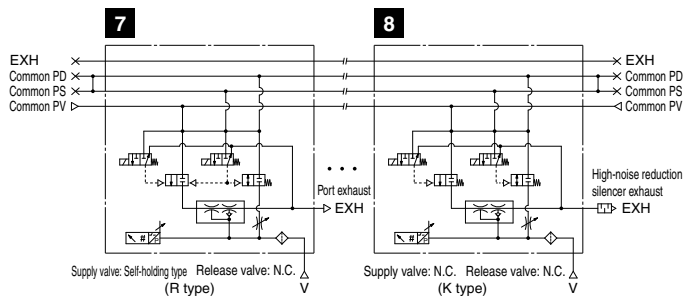

Port layout No. 8

Single unit: ZK2H□□□□□-□
Manifold: ZZK2□□-A2□

System	Ejector
Body type	Manifold
Exhaust type	High-noise reduction silencer exhaust
Application and purpose	Common for each station
Vacuum pressure	Common for each station
Exhaust	Released in operating environment
Release pressure	Same pressure as common PV

Option -D

Port layout No. 9

Single unit: ZK2P00□□□□□-D

System	Vacuum pump
Body type	Single unit
Exhaust type	Without silencer
Application and purpose	—
Vacuum pressure	—
Exhaust	—
Release pressure	PD pressure has to be supplied with PS pressure.

Port combination: PV ≠ PS ≠ PD

Circuit example

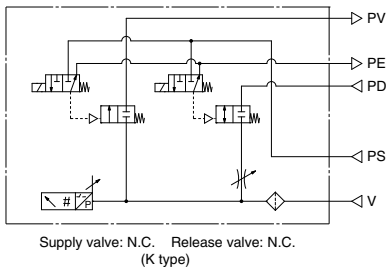

Refer to page 79 for the purpose of port and the operating pressure range.

ZK2

ZQ

ZR

ZB

ZA

ZX

ZM

ZL

ZH

ZH-X267

ZHP

ZU

VQD-V

ZK2 Series

Port Layout

*System depends on vacuum source (vacuum pump/vacuum ejector).

Option -D

Port layout No. 10

Single unit: ZK2Q00□□□□-□

Manifold: ZK2□□-P2□□-D

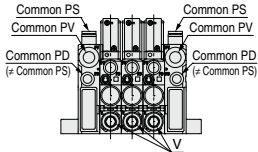

System	Vacuum pump
Body type	Manifold
Exhaust type	Without silencer
Application and purpose	Vacuum pressure: Common for each station
	Exhaust: —
	Release pressure: Common PD pressure has to be supplied with common PS

Port combination: Common PV ≠ Common PS ≠ Common PD

Circuit example

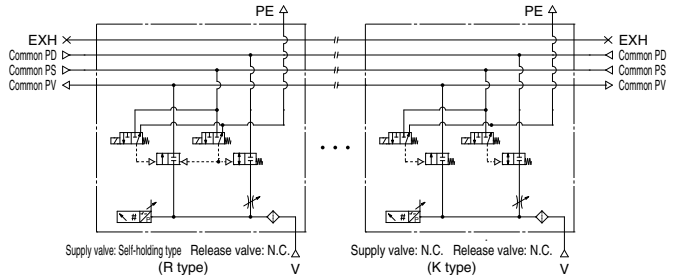

Port layout No. 11

Single unit: ZK2A□□□□□□-□-D

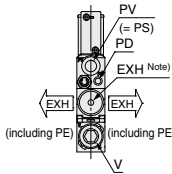

System	Ejector
Body type	Single unit
Exhaust type	Silencer exhaust
Application and purpose	Vacuum pressure: —
	Exhaust: Released in operating environment
	Release pressure: PD pressure has to be supplied with PV pressure.

Port combination: PV = PS ≠ PD

Circuit example

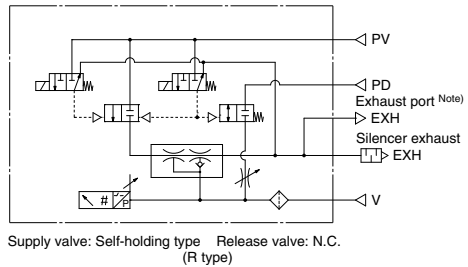

Note) Nozzle size: 12, 15

Port layout No. 12

Single unit: ZK2B□□□□□□-□-D

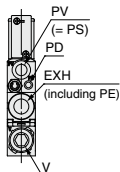

System	Ejector
Body type	Single unit
Exhaust type	Port exhaust
Application and purpose	Vacuum pressure: —
	Exhaust: After piping, individual exhaust is necessary
	Release pressure: PD pressure has to be supplied with PV pressure.

Port combination: PV = PS ≠ PD

Circuit example

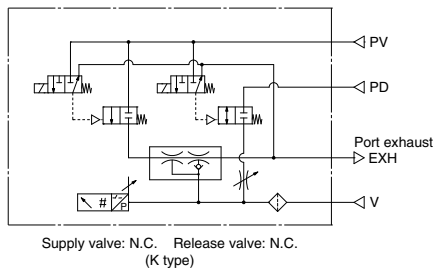

Refer to page 79 for the purpose of port and the operating pressure range.

Port Layout

*System depends on vacuum source (vacuum pump/vacuum ejector).

Option -D

Port layout No. **13**

Single unit: ZK2G□□□□□-□-**D**

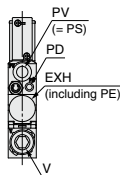

System	Ejector
Body type	Single unit
Exhaust type	High-noise reduction silencer exhaust
Vacuum pressure	Common for each station
Application and purpose	Exhaust: Released in operating environment
Release pressure	PD pressure has to be supplied with PV pressure.

Port combination: PV = PS ≠ PD

Circuit example

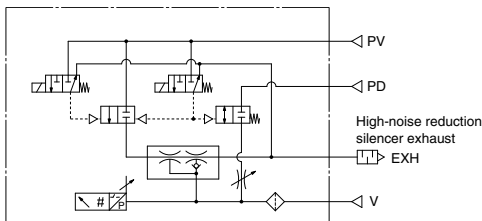

Supply valve: Self-holding type Release valve: N.C. (R type)

ZK2

ZQ

ZR

ZB

ZA

ZX

ZM

ZL

ZH

ZH

ZH-X267

ZHP

ZU

VQD-V

Port layout No. **14**

Single unit: ZK2C□□□□□-□-**P**
Manifold: ZK2□□-A1□-**D**

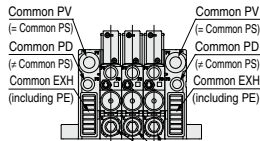

Note) The complex exhaust is a combined exhaust method of the common exhaust from the end plate and the direct exhaust from each station.

System	Ejector
Body type	Manifold
Exhaust type	Complex exhaust ^{Note)}
Vacuum pressure	Common for each station
Application and purpose	Exhaust: Released in operating environment
Release pressure	Common PD pressure has to be supplied with common PV.

Port combination: Common PV = Common PS ≠ Common PD

Circuit example

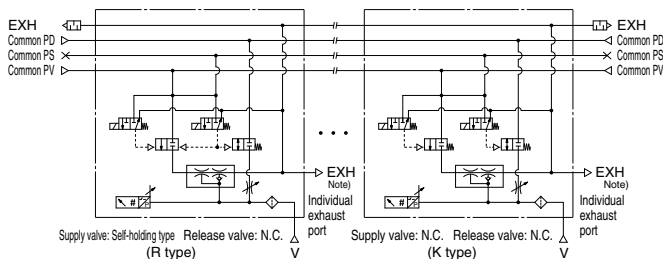

Note) For complex exhaust type, individual exhaust port is provided to each station.

Port layout No. **15**

Single unit: ZK2F□□□□□-□-**P**
Manifold: ZK2□□-A2□-**D**

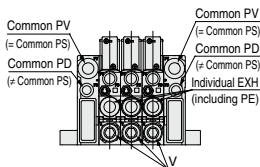

System	Ejector
Body type	Manifold
Exhaust type	Individual port exhaust
Vacuum pressure	Common for each station
Application and purpose	Exhaust: After spring, individual exhaust is necessary.
Release pressure	Common PD pressure has to be supplied with common PV.

Port combination: Common PV = Common PS ≠ Common PD

Circuit example

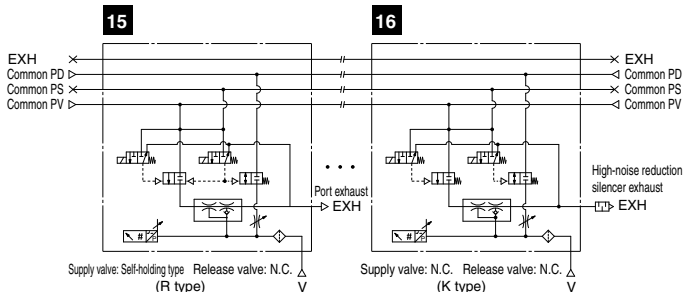

Refer to page 79 for the purpose of port and the operating pressure range.

ZK2 Series

Port Layout

*System depends on vacuum source (vacuum pump/vacuum ejector).

Option -D

Port layout No. 16

Single unit: ZK2H□□□□□□□-P
Manifold: ZZK2□□□-A2□□-D

System	Ejector	
Body type	Manifold	
Exhaust type	High-noise reduction silencer exhaust	
Application and purpose	Vacuum pressure	Common for each station
	Exhaust	Released in operating environment
	Release pressure	PD pressure has to be supplied with PV pressure.

Port combination: Common PV = Common PS ≠ Common PD

Circuit example

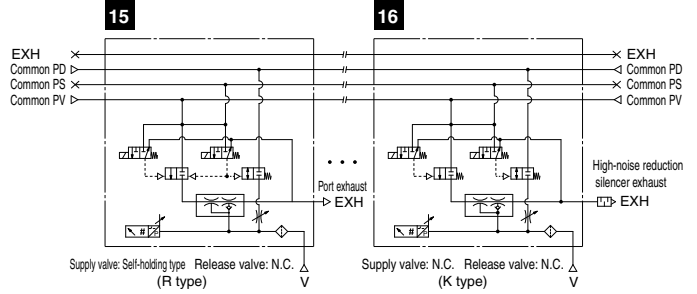

Option -L

Port layout No. 17

Single unit: ZK2C□□□□□□□□□-L
Manifold: ZZK2□□□-A1□□-L

Note) The complex exhaust is a combined exhaust method of the common exhaust from the end plate and the direct exhaust from each station.

System	Ejector	
Body type	Manifold	
Exhaust type	Complex exhaust ^{Note)}	
Application and purpose	Vacuum pressure	PV pressure can be changed per station.
	Exhaust	Released in operating environment
	Release pressure	Same pressure for common PS and common PD

Port combination: Individual PV ≠ Common PS = Common PD

Circuit example

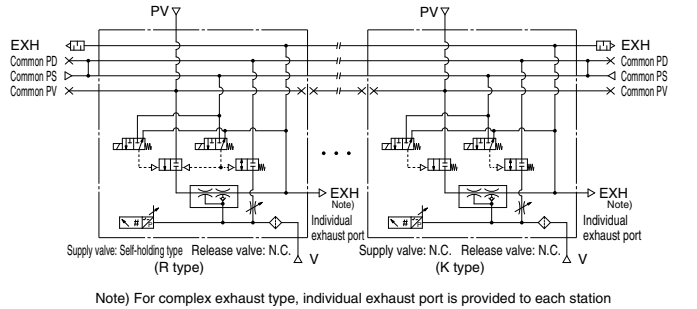

Port layout No. 18

Single unit: ZK2F□□□□□□□□□-L
Manifold: ZZK2□□□-A2□□-L

System	Ejector	
Body type	Manifold	
Exhaust type	Individual port exhaust	
Application and purpose	Vacuum pressure	PV pressure can be changed per station.
	Exhaust	After spring, individual exhaust is necessary.
	Release pressure	Same pressure for common PS and common PD

Port combination: Individual PV ≠ Common PS = Common PD

Circuit example

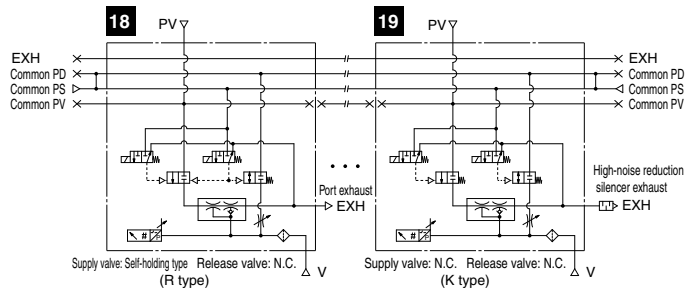

Refer to page 79 for the purpose of port and the operating pressure range.

Port Layout

*System depends on vacuum source (vacuum pump/vacuum ejector).

Option -L

Port layout No. **19**

Single unit: ZK2H□□□□□-L
Manifold: ZK2□□-A2□-L

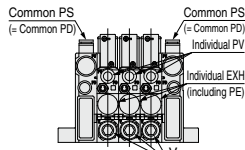

System		Ejector
Body type		Manifold
Exhaust type		High-noise reduction silencer exhaust
Application and purpose	Vacuum pressure	PV pressure can be changed per station.
	Exhaust	Released in operating environment
	Release pressure	Same pressure for common PS and common PD

Port combination: Individual PV ≠ Common PS = Common PD

Circuit example

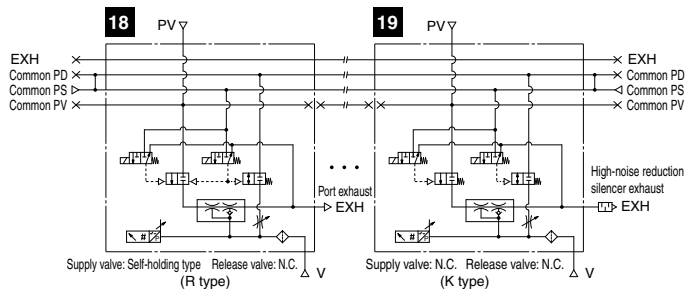

ZK2

ZQ

ZR

ZB

ZA

ZX

ZM

ZL

ZH

ZH

ZH
-X267

ZHP

ZU

VQD-V

Application and Operating Pressure Range of Each Port

Port	Description	Vacuum Ejector System	Vacuum Pump System
PV	Air pressure supply port (Operating pressure range)	Compressed air supply for operating ejector 0.3 to 0.6 MPa ^{*1)}	—
	Vacuum pressure supply port (Operating pressure range)	—	Vacuum source (Vacuum pump) 0 to -101 kPa
PS	Pilot pressure supply port (Operating pressure range)	—	Compressed air supply for pilot valve 0.3 to 0.6 MPa
PD	Individual release pressure supply port (Operating pressure range)	Release pressure Compressed air supply for individual setting (Option) 0 to 0.6 MPa (PD ≤ PV)	0 to 0.6 MPa (PD ≤ PS)
V	Vacuum port	For connecting adsorption equipment including pad	
EXH	Exhaust port	Exhaust when ejector operates ^{*2)}	—
PE	Pilot pressure exhaust port	Exhaust when valve operates ^{*3)}	

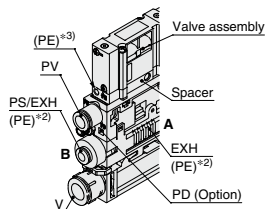

*1) For models without valve, pressure can be 0.3 MPa or less.

*2) For ejectors with silencer, air exhausts from A (slit on both sides). For port exhaust type, air exhausts from B.

*3) Pilot pressure for ejectors is exhausted from the ejector and the common exhaust. Pump system exhausts air from PE port on the spacer. (Female thread type (M3) is available by option (-C) for PE port of the pump system.)

ZK2 Series

Construction

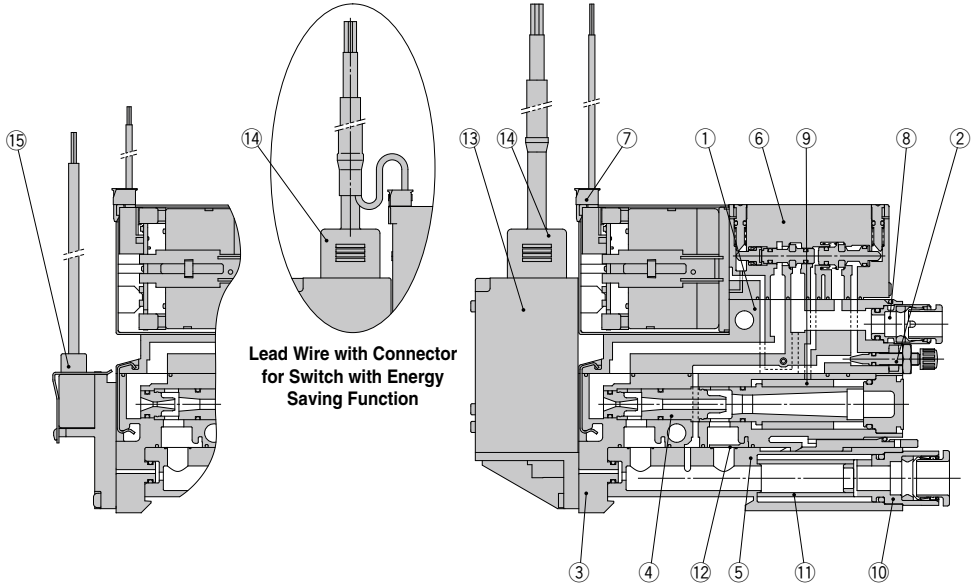

Lead Wire with Connector for Switch with Energy Saving Function

With Pressure Sensor

With Pressure Switch for Vacuum

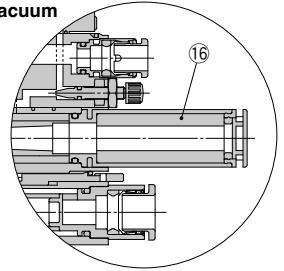

With High-noise Reduction Silencer

Component Parts

No.	Description	Material	Note
1	Valve body assembly	Resin	HNBR, NBR and steel are also used.
2	Needle assembly	Brass	Electroless nickel plated brass, resin, steel and NBR are used.
3	Ejector body assembly	Resin	HNBR, NBR and steel are also used.
4	Ejector assembly	Resin	NBR is also used.
5	Filter case assembly	Resin	Case body: Polycarbonate (Refer to Specific Product Precautions on page 95.)

Replacement Parts

No.	Description	Note
6	Valve assembly	
7	Connector assembly	Connector for solenoid valve 3 wire (For double), 2 wire (For single)
8	One-touch fitting assembly	Standard supply (PV) port: $\phi 6, \phi 1/4"$
9	Sound absorbing material	10 pcs. per set
10	Vacuum port adapter assembly	With One-touch fitting and filter element (Case material: Polycarbonate)
11	Filter element	Nominal filtration rating: 30 μm , 10 pcs. per set
12	Check valve	For replacement or addition for manifold exhaust interference prevention (10 pcs. per set)
13	Vacuum pressure switch assembly	With 2 screws and 1 gasket
14	Lead wire with connector	
15	Pressure sensor assembly	With 2 screws and 1 gasket
16	High-noise reduction silencer case assembly	With sound absorbing material (Part number: ZK2-SE3-6-A)

Replacement Parts/How to Order

⑥ Valve assembly

ZK2 - VA **A** **K** **5** **L** - A

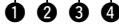

① Applicable system

A	For ejector system
P	For vacuum pump system

② Valve type

K	Supply valve N.C., Release valve N.C.
R	Supply valve, self-holding type (Linked to release valve)
J	Supply valve only (Single)

③ Rated voltage

5	24 VDC
6	12 VDC

④ Lead wire entry direction

C	For plug-in (Manifold common wiring)
L	L-type plug connector with lead wire (Individual wiring)
LO	L-type plug connector, without connector

Select the ZK2-VAACKL□□-A for a switch with energy saving function.
This assembly does not include special cable assembly for a switch with energy saving function.

⑦ Connector assembly

ZK2 - LV **W** □ - A

Applicable valve type

W	Valve type K/R (With supply valve and release valve)
S	Valve type J (Supply valve only)

Lead wire length

Nil	300 mm
6	600 mm
10	1000 mm
20	2000 mm
30	3000 mm

For single

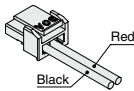

For double

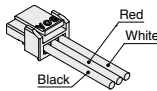

⑧ One-touch fitting assembly

(Purchasing order is available in units of 10 pieces.)

KJH **04** - C2

Port size

04	ø4 One-touch fitting (Straight)	Metric size
06	ø6 One-touch fitting (Straight)	Metric size
03	ø5/32" One-touch fitting (Straight)	Inch size
07	ø1/4" One-touch fitting (Straight)	Inch size

⑨ Sound absorbing material (10 pcs. per set)

ZK2 - SE1 - **1** - A

Sound absorbing material holes diameter

1	300 μm
----------	--------

⑩ Vacuum port adapter assembly

ZK2 - VA1S **8** - A

One-touch fitting size

6	ø6 One-touch fitting	Metric size
8	ø8 One-touch fitting	Metric size
7	ø1/4" One-touch fitting	Inch size
9	ø5/16" One-touch fitting	Inch size

⑪ Filter element (10 pcs. per set)

ZK2 - FE1 - **3** - A

Nominal filtration rating

3	30 μm
----------	-------

⑫ Check valve ^{Note)} (10 pcs. per set)

ZK2 - CV - A

Note) When mounting a check valve additionally, the workpiece may not be removed unless vacuum release pressure is applied.

⑬ Pressure switch for vacuum assembly

ZK2 - ZS **E** **A** **M** **G** □ - A

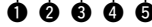

① Rated pressure range and function

E	0 to -101 kPa	Pressure switch for vacuum	Open collector 2 outputs
F	-100 to 100 kPa		
V	-100 to 100 kPa	Pressure switch with energy saving function	Open collector 1 output

② Output specifications

A	NPN
B	PNP

③ Unit specifications

Nil	Unit selection function ^{Note 1)}
M	SI unit only ^{Note 2)}

Note 1) Unit selection function is not available in Japan due to measurement law.

Note 2) Fixed unit: kPa

④ Lead wire with connector

Nil	None	
G	With lead wire	When 1 is E or F--For pressure switch for vacuum, Lead wire with connector (Length 2 m)
		When 1 is V--For switch with energy saving function, Lead wire with connector (Length 2 m)

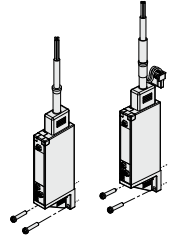

⑤ Mounting ^{Note)}

Nil	Mounted to the single unit
L	Mounted to the manifold

The screw length mounted to the ejector is different.

Note) When ordering an ejector without valve, select Nil for mounting.

⑭ Lead wire with connector for pressure switch for vacuum

(When individual lead wire is necessary, order with the port number below.)

- Lead wire with connector for pressure switch for vacuum **ZS - 39 - 5G**
- Lead wire with connector for switch with energy saving function **ZK2 - LW **A** 20 - A**

Output specifications

A	NPN open collector
B	PNP open collector

⑮ Pressure sensor assembly

ZK2 - PS **1** □ - A

Rated pressure range and specifications

1	0 to -101 kPa, Output: 1 to 5 V, Accuracy: ±2% F.S. or less
3	-100 to 100 kPa, Output: 1 to 5 V, Accuracy: ±2% F.S. or less

Mounting ^{Note)}

Nil	Mounted to the single unit
L	Mounted to the manifold

The screw length mounted to the ejector is different.

Note) When ordering an ejector without valve, select Nil for mounting.

⑯ High-noise reduction silencer case assembly

ZK2 - SC3 - **4** - A

Exhaust port size

4	ø4 For nozzle size 07, 10
6	ø6 For nozzle size 12, 15

ZK2

ZQ

ZR

ZB

ZA

ZX

ZM

ZL

ZH

ZH

ZH

ZH-X267

ZHP

ZU

VQD-V

Vacuum Unit

ZK2 Series

Exploded View of Manifold

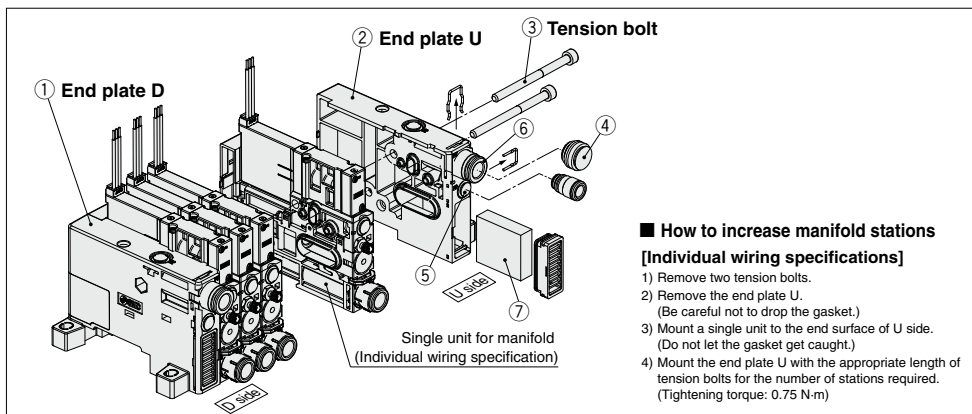

■ How to increase manifold stations [Individual wiring specifications]

- 1) Remove two tension bolts.
- 2) Remove the end plate U.
(Be careful not to drop the gasket.)
- 3) Mount a single unit to the end surface of U side.
(Do not let the gasket get caught.)
- 4) Mount the end plate U with the appropriate length of tension bolts for the number of stations required.
(Tightening torque: 0.75 N·m)

Component Parts

No.	Description	Material	Note
1	End plate D assembly	Resin	HNBR, NBR and steel are also used.
2	End plate U assembly	Resin	Electroless nickel plated brass, resin, steel and NBR are used.

Replacement Parts

No.	Description	Note
3	Tension bolt assembly	2 pcs. per set
4	Port plug assembly	Plug for changing PV port to single side supply type (Common for mm and inch type)
5	Port plug assembly	Plug for changing PS or PD port to single side supply type (Common for mm and inch type)
6	One-touch fitting assembly	Metric size: ø8, Inch size: ø5/16"
7	Sound absorbing material	2 pcs. per set - Material: Non-woven cloth (Silencer cover is not included.)
8	DIN rail	Refer to Dimensions (from page 88 and after) for the recommended length for each number of manifolds stations.
9	Connector housing assembly	Available connector is even number only. (If you need a connector for odd number, specify the connector of the number you need + 1 station.)

Note) When ordering a manifold "ZZK2-□-□-□-□-□-□-□-□" on page 64, ① to ③ are delivered as a set.

Replacement Parts/How to Order

③ Tension bolt assembly (2 pcs. per set)

ZK2 - TB1 - 05 - A

↓ Applicable stations

01	For 1 station manifold
⋮	
10	For 10 stations manifold

④ Port plug assembly
(Purchasing order is available in units of 1 piece.)

VVQZ2000 - CP

⑤ Port plug assembly
(Purchasing order is available in units of 1 piece.)

ZK2 - MP1C6 - A

⑥ One-touch fitting assembly
(Purchasing order is available in units of 10 pieces.)

VVQ1000 - 51A - C8

↓ Port size

C8	ø8 One-touch fitting
N9	ø5/16" One-touch fitting

⑦ Sound absorbing material (2 pcs. per set)

ZK2 - SE2 - 1 - A

⑧ DIN rail

AXT100 - DR - 5

↓ Length symbols ↓

1	to	40
L = 23	to	L = 510.5

[L = 12.5 x ■ + 10.5]

■: Length symbols 1 to 40

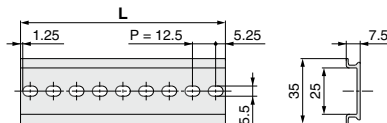

L Dimension

L = 12.5 x n + 10.5

No.	1	2	3	4	5	6	7	8	9	10
L Dimension	23	35.5	48	60.5	73	85.5	98	110.5	123	135.5
No.	11	12	13	14	15	16	17	18	19	20
L Dimension	148	160.5	173	185.5	198	210.5	223	235.5	248	260.5
No.	21	22	23	24	25	26	27	28	29	30
L Dimension	273	285.5	298	310.5	323	335.5	348	360.5	373	385.5
No.	31	32	33	34	35	36	37	38	39	40
L Dimension	398	410.5	423	435.5	448	460.5	473	485.5	498	510.5

■ How to increase manifold stations

[To increase the number of stations from odd number (1, 3, 5, 7, 9) in common wiring type to even number (2, 4, 6, 8, 10)]
 (Common wiring of odd number station has a vacant connector for one station. Easy to add a station.)

- 1) Remove the tension bolt.
- 2) Remove the end plate U.
- 3) Remove the valve assembly of a single unit for extra station(s) for manifold.
- 4) Remove the switch assembly if it is present. (Be careful not to drop the O-ring. Refer to **Fig.1**.)
- 5) Remove the junction box B (top) using a precision screwdriver. (Refer to **Fig.2**.)
- 6) Mount the extra connector to the junction box B. (Refer to **Fig.3**) (Engage the recess of the connector and the protrusion of the junction box B. (Refer to **Fig.3-A**.)
- 7) Mount a single unit for extra station(s) for manifold to the end surface of U side. (Do not let the gasket or lead wire get caught.)
- 8) Mount the end plate U with the appropriate length of tension bolts for the number of stations required. (Tightening torque: 0.75 N·m.)
- 9) Mount the junction box B to the junction box A.
- 10) Assemble the valve assembly. (Tightening torque: 0.15 N·m)
- 11) For products with a switch, mount the switch assembly. (Be careful not to drop the O-ring. Tightening torque: 0.08 to 0.10 N·m)

[To increase the number of stations from even number to odd number, or increase two stations or more]

- 1) Remove the valve assembly for all stations. (Single unit for extra station is also removed.)
- 2) Remove the switch assembly if it is present. (Be careful not to drop the O-ring. Refer to **Fig.1**.)
- 3) Remove the junction box B (top) for all stations using a precision screwdriver. (Refer to **Fig.2**.) (Remove the junction box B from D side.)
- 4) Remove all connectors mounted to the junction box B. (Be careful not to break the connector clip.)
- 5) Remove the tension bolt.
- 6) Remove the end plate D assembly.
- 7) Remove the connector housing assembly from the end plate D assembly. (Refer to **Fig.4**.)
- 8) Mount the connector housing assembly for extra station(s) to the end plate D assembly. (Refer to **Fig.4**.) (Insert two clips of the housing mounting surface to the square holes of the end plate, and slide the connector housing assembly.)
- 9) Remove the end plate U. (Be careful not to drop the gasket.)
- 10) Mount a single unit for extra station(s) for manifold to the end surface of U side. Do not let the gasket get caught.
- 11) Mount the end plate U and D with the appropriate length of tension bolts for the number of stations required. (Tightening torque: 0.75 N·m.)
- 12) Mount the connector for all stations to the junction box B. (Refer to **Fig.3**.) (Engage the recess of the connector and the protrusion of the junction box B. (Refer to **Fig.3-A**.)
- 13) Mount the junction box A to the junction box B. Push the wires down the side and mount the junction box A to the junction box B following a decreasing mark tube numbers from U side. (Do not let the lead wire get caught.)
- 14) Assemble the valve assembly. (Tightening torque: 0.15 N·m)
- 15) For products with a switch, mount the switch assembly. (Be careful not to drop the O-ring. Tightening torque: 0.08 to 0.10 N·m)

-When adding a pump system, the pump spacer for extra station is required separately.

Fig. 3-A
 Connector recess, The side with square hole faces the body, Protrusion of junction box B

Fig. 3
 Clip, Clip in.

Fig. 2
 How to remove the junction box B

Fig. 1
 Gasket

Fig. 4
 End plate D assembly, Square hole, U side, D side, Mark tube (Station number indication)

When ordering ejector for pump system, spacer is included.
 Pump spacer* (Part no.: ZK2-SS1-A)

Assembled unit

9 Connector housing assembly
ZK2-CH 2 04 - A

● Applicable stations

02	For 2 stations manifold
04	For 4 stations manifold
06	For 6 stations manifold
08	For 8 stations manifold
10	For 10 stations manifold

● Connector type

1	D sub-connector (25 pins)
2	Flat ribbon cable (26 pins)

■ Plug (For One-touch fitting) (Purchasing order is available in units of 10 pieces.)
 Mounted onto ports which are not used (PV, PS, PD, etc.)

KQ2P-06

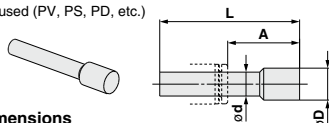

● Model and dimensions

Symbol	Applicable size ød	A	L	øD	Weight [g]	Note
06	ø6	18	35	8	1	White
08	ø8	20.5	39	10	2	White
07	ø1/4"	18	35	8.5	1	Orange
09	ø5/16"	20.5	39	10	2	Orange

ZK2 Series

Dimensions: Single Unit

ZK2^A_B□^K_R□NL2-□

Ejector system, Single unit, With supply valve/release valve, Without pressure sensor/switch

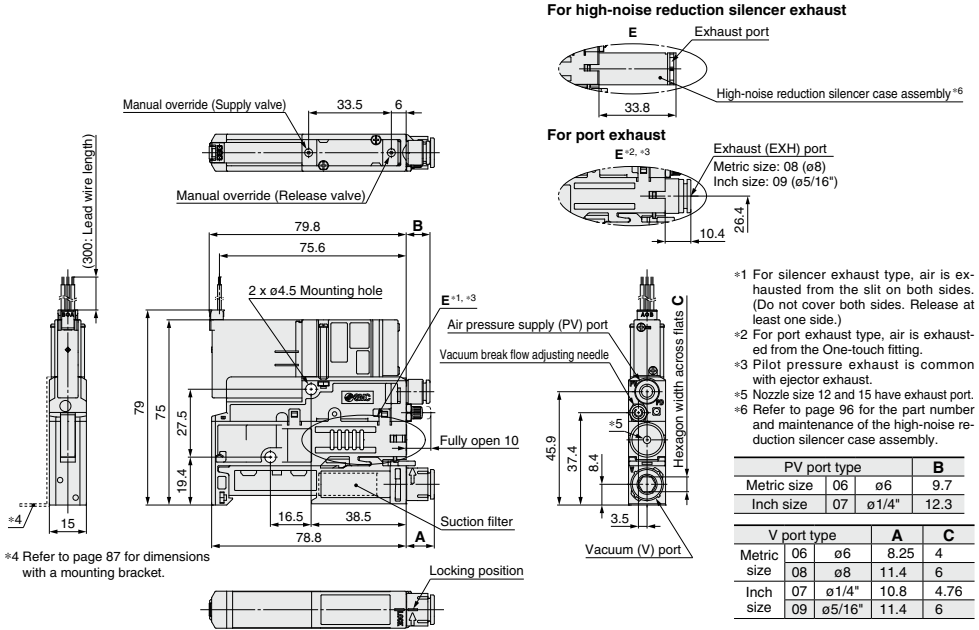

ZK2P00^K_R□NL2-□

Vacuum pump system, Single unit, With supply valve/release valve, Without pressure sensor/switch

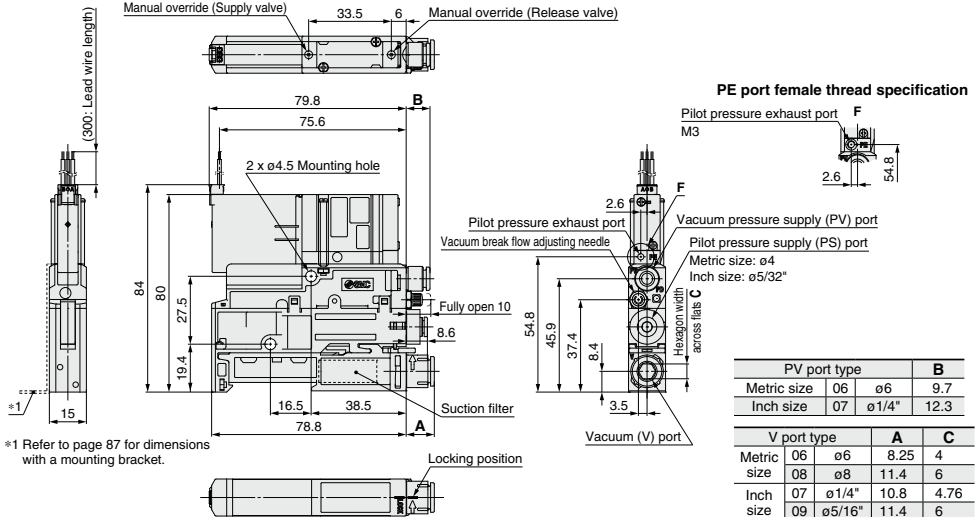

Dimensions: Single Unit

ZK2_B□□NL2-□

Ejector system, Single unit, With supply valve, Without pressure sensor/switch

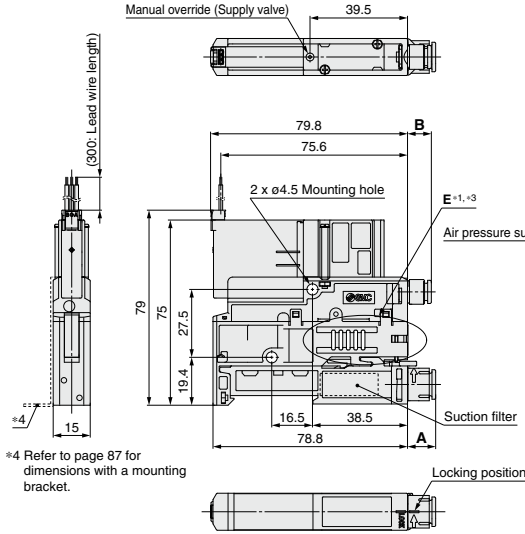

For high-noise reduction silencer exhaust

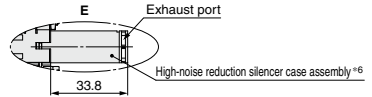

For port exhaust

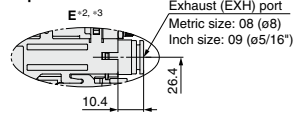

- *1 For silencer exhaust type, air is exhausted from the slit on both sides. (Do not cover both sides. Release at least one side.)
- *2 For port exhaust type, air is exhausted from the One-touch fitting.
- *3 Pilot pressure exhaust is common with ejector exhaust.
- *5 Nozzle size 12 and 15 have exhaust port.
- *6 Refer to page 96 for the part number and maintenance of the high-noise reduction silencer case assembly.

PV port type		B	
Metric size	06 $\phi 6$	8.25	9.7
Inch size	07 $\phi 1/4$ "	11.4	12.3

V port type		A	C
Metric size	06 $\phi 6$	8.25	4
Inch size	07 $\phi 1/4$ "	10.8	4.76
Inch size	09 $\phi 5/16$ "	11.4	6

ZK2_B□□N0NN-□

Ejector system, Single unit, Without valve, Without pressure sensor/switch

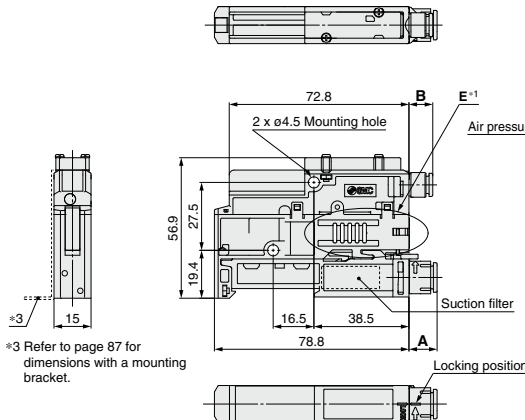

For high-noise reduction silencer exhaust

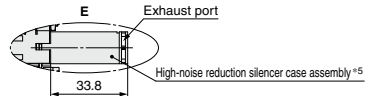

For port exhaust

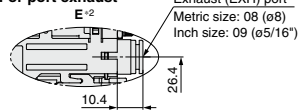

- *1 For silencer exhaust type, air is exhausted from the slit on both sides. (Do not cover both sides. Release at least one side.)
- *2 For port exhaust type, air is exhausted from the One-touch fitting.
- *4 Nozzle size 12 and 15 have exhaust port.
- *5 Refer to page 96 for the part number and maintenance of the high-noise reduction silencer case assembly.

PV port type		B	
Metric size	06 $\phi 6$	8.25	9.7
Inch size	07 $\phi 1/4$ "	11.4	12.3

V port type		A	C
Metric size	06 $\phi 6$	8.25	4
Inch size	07 $\phi 1/4$ "	10.8	4.76
Inch size	09 $\phi 5/16$ "	11.4	6

ZK2 Series

Dimensions: Single Unit

ZK2 $\frac{A}{B}$ $\frac{K}{R}$ $\frac{P}{T}$ L- \square

Ejector system, Single unit, With supply valve/release valve, With pressure sensor

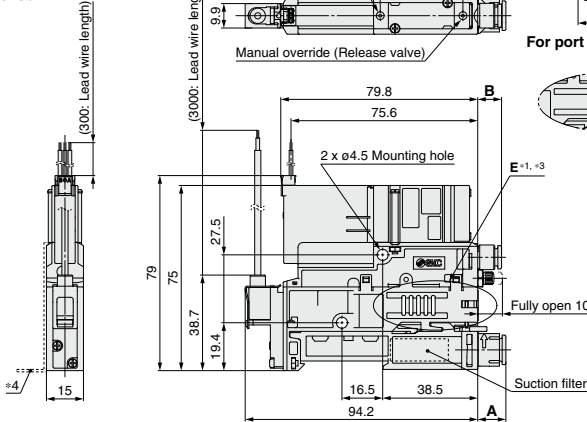

For high-noise reduction silencer exhaust

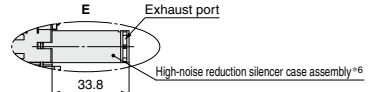

For port exhaust

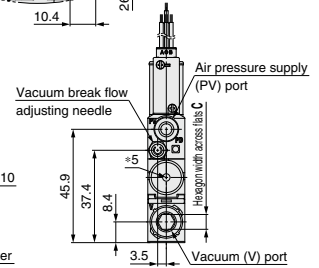
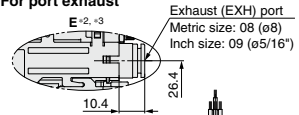

*1 For silencer exhaust type, air is exhausted from the slit on both sides.

(Do not cover both sides. Release at least one side.)

*2 For port exhaust type, air is exhausted from the One-touch fitting.

*3 Pilot pressure exhaust is common with ejector exhaust.

*4 Refer to page 87 for dimensions with a mounting bracket.

*5 Nozzle size 12 and 15 have exhaust port.

*6 Refer to page 96 for the part number and maintenance of the high-noise reduction silencer case assembly.

V port type		A	C
Metric size	ø6	8.25	4
	ø8	11.4	6
Inch size	ø1/4"	10.8	4.76
	ø5/16"	11.4	6

PV port type			B
Metric size	ø6	ø6	9.7
Inch size	ø7	ø1/4"	12.3

ZK2 $\frac{A}{B}$ $\frac{K}{R}$ $\frac{P}{T}$ L- \square
A to J

Ejector system, Single unit, With supply valve/release valve, With pressure switch

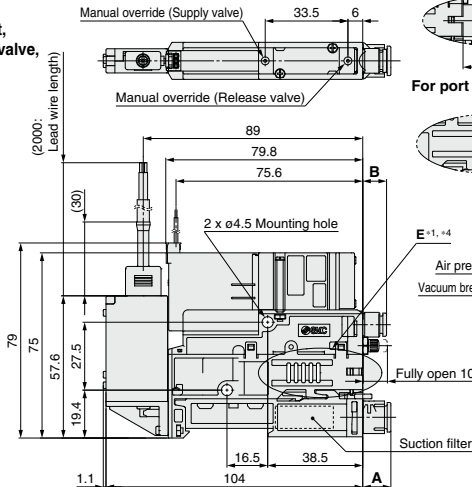
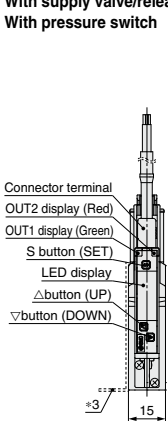

For high-noise reduction silencer exhaust

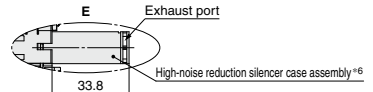

For port exhaust

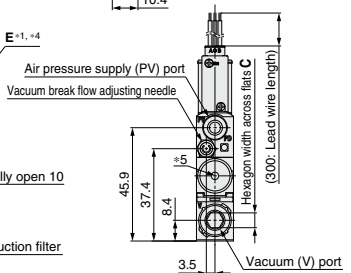
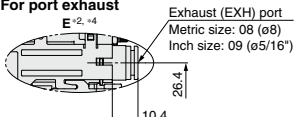

*1 For silencer exhaust type, air is exhausted from the slit on both sides.

(Do not cover both sides. Release at least one side.)

*2 For port exhaust type, air is exhausted from the One-touch fitting.

*3 Pilot pressure exhaust is common with ejector exhaust.

*4 Refer to page 87 for dimensions with a mounting bracket.

*5 Nozzle size 12 and 15 have exhaust port.

*6 Refer to page 96 for the part number and maintenance of the high-noise reduction silencer case assembly.

V port type		A	C
Metric size	ø6	8.25	4
	ø8	11.4	6
Inch size	ø1/4"	10.8	4.76
	ø5/16"	11.4	6

PV port type			B
Metric size	ø6	ø6	9.7
Inch size	ø7	ø1/4"	12.3

Dimensions: Single Unit

With bracket

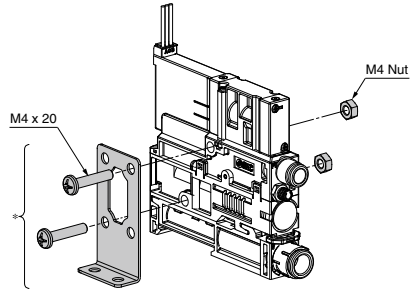
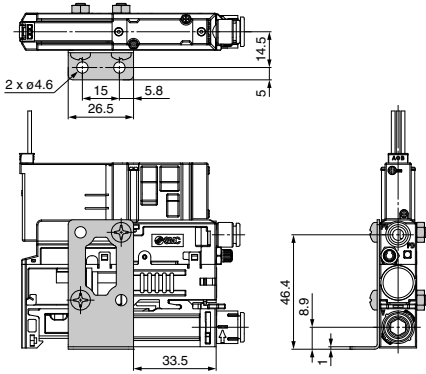

*Mounting bracket for single unit (Option), [Nuts and bolts are included.]
Part number: ZK2-BK1-A

ZK2
ZQ
ZR
ZB
ZA
ZX
ZM
ZL
ZH
ZH
ZH-X267
ZHP
ZU
VQD-V

ZK2 Series

Dimensions: Manifold Individual Wiring

ZZK2□-P□□L

Ejector system, Vacuum pump system, Individual wiring manifold, With supply valve/release valve, Without pressure sensor/switch

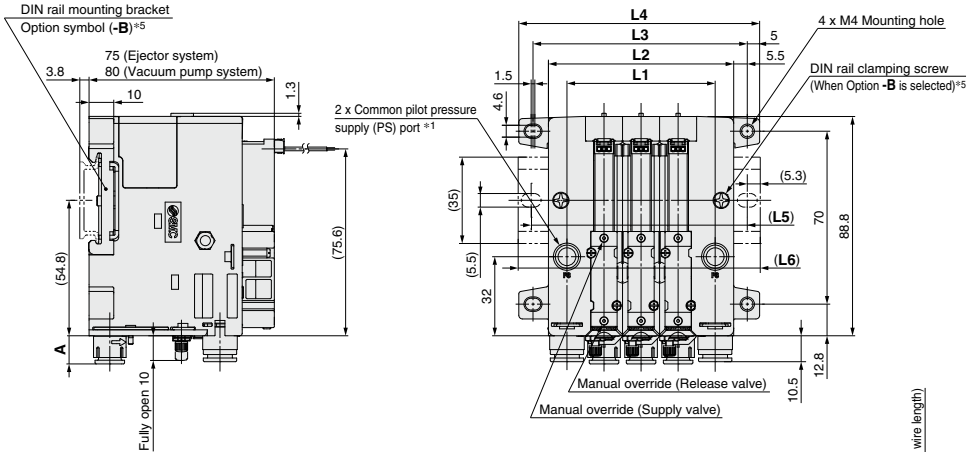

D side (Number of stations) 1 2 3 n U side

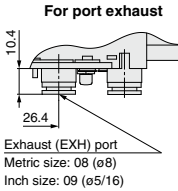

PE port female thread specification (ZZK2□-P□□L)

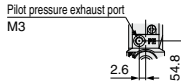

For high-noise reduction silencer exhaust

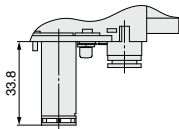

PS and PD port dimensions *1, *3-4

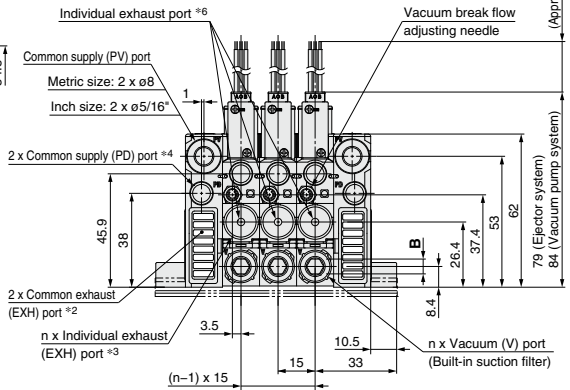
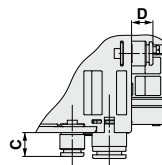

Port type	A	Hexagon width across flats B	C	D
Metric size 06	8.3	4	9.7	8.7
Metric size 08	11.4	6	—	—
Inch size 07	10.8	4.76	12.3	11.3
Inch size 09	11.4	6	—	—

Number of stations	[mm]									
	1	2	3	4	5	6	7	8	9	10
L1	30	45	60	75	90	105	120	135	150	165
L2	45	60	75	90	105	120	135	150	165	180
L3	56.8	71.8	86.8	101.8	116.8	131.8	146.8	161.8	176.8	191.8
L4	67.5	82.5	97.5	112.5	127.5	142.5	157.5	172.5	187.5	202.5
L5	62.5	75	87.5	112.5	125	137.5	150	162.5	187.5	200
L6	73	85.5	98	123	135.5	148	160.5	173	198	210.5

*1 Common pilot pressure supply port is available for vacuum pump system or option L (Manifold individual supply specification). (mm: ø6 inch: ø1/4")

*2 Pump system with individual exhaust port type does not have exhaust port.

*3 When individual exhaust port type is selected (Body type: F)

*4 Only when common PD port type option (Symbol: -D) is selected (mm: ø6 inch: ø1/4")

*5 To fix the manifold to DIN rail, select an option for the manifold model number.

*6 For complex exhaust type, air is also exhausted from the individual exhaust port of each station in addition to the common exhaust. (Ejector system)

Dimensions: Manifold D-sub Connector

ZZK2□-P□□F

Ejector system, Vacuum pump system, Common wiring manifold, With supply valve/release valve, With pressure sensor

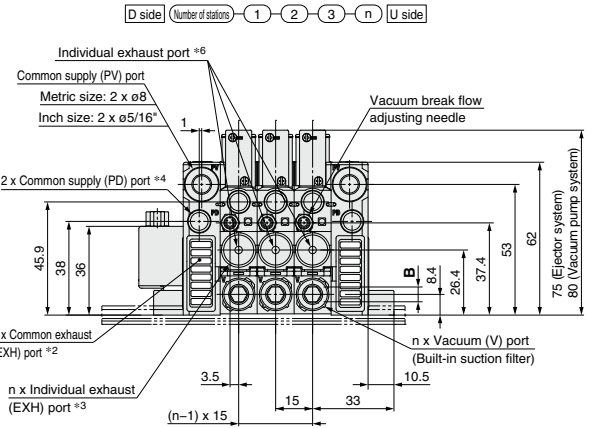
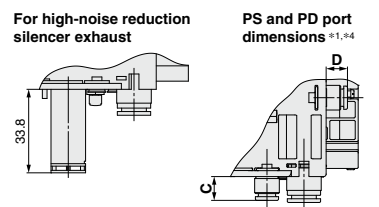
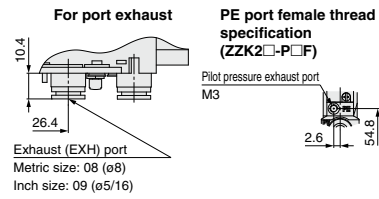
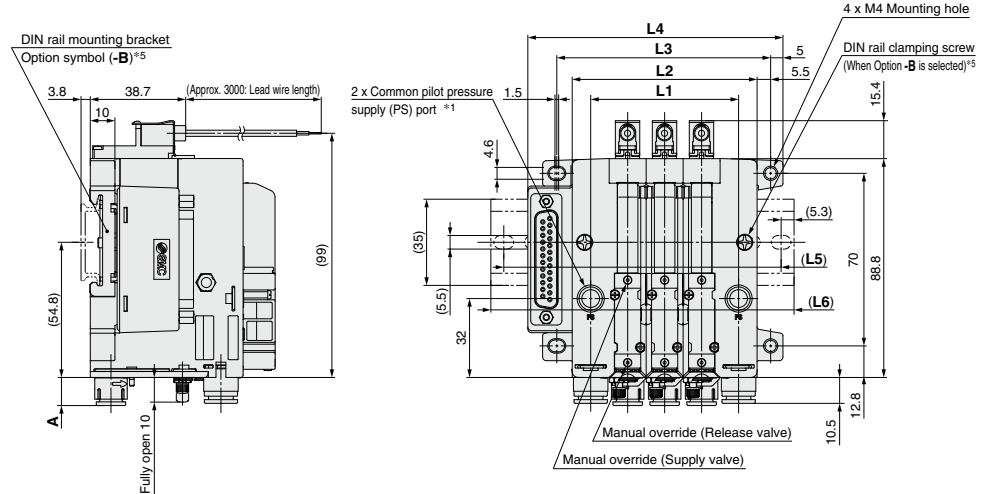

Port type	A	Hexagon width across flats B	C	D
Metric size 06	8.3	4	9.7	8.7
Metric size 08	11.4	6	—	—
Inch size 07	10.8	4.76	12.3	11.3
Inch size 09	11.4	6	—	—

Number of stations	[mm]									
	1	2	3	4	5	6	7	8	9	10
L1	30	45	60	75	90	105	120	135	150	165
L2	45	60	75	90	105	120	135	150	165	180
L3	56.8	71.8	86.8	101.8	116.8	131.8	146.8	161.8	176.8	191.8
L4	73.5	88.5	103.5	118.5	133.5	148.5	163.5	178.5	193.5	208.5
L5	75	100	112.5	125	137.5	150	175	187.5	200	212.5
L6	85.5	110.5	123	135.5	148	160.5	185.5	198	210.5	223

#1 Common pilot pressure supply port is available for vacuum pump system or option L (Manifold individual supply specification). (mm: ø6 inch: ø1/4")
 #2 Pump system with individual exhaust port type does not have exhaust port.
 #3 When individual exhaust port type is selected (Body type: F)
 #4 Only when common PD port type option (Symbol: -D) is selected (mm: ø6 inch: ø1/4")
 #5 To fix the manifold to DIN rail, select an option for the manifold model number.
 #6 For complex exhaust type, air is also exhausted from the individual exhaust port of each station in addition to the common exhaust. (Ejector system)

ZK2
ZQ
ZR
ZB
ZA
ZX
ZM
ZL
ZH
ZH-X267
ZHP
ZU
VQD-V

ZK2 Series

Dimensions: Manifold Flat Ribbon Cable

ZK2□-P_A□P

Ejector system, Common wiring manifold, With supply valve/release valve, With pressure switch

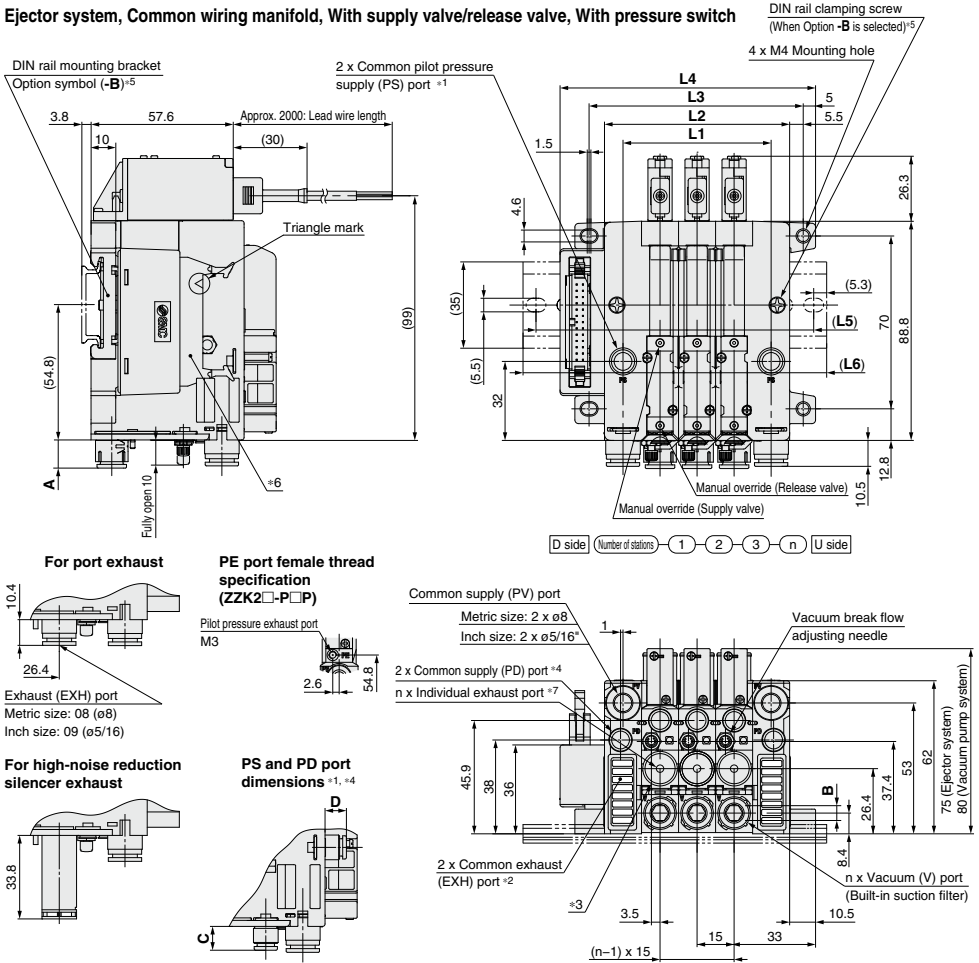

Port type	A	Hexagon width across flats B	C	D
Metric size 06	8.3	4	9.7	8.7
08	11.4	6	—	—
Inch size 07	10.8	4.76	12.3	11.3
09	11.4	6	—	—

Number of stations	[mm]									
	1	2	3	4	5	6	7	8	9	10
L1	30	45	60	75	90	105	120	135	150	165
L2	45	60	75	90	105	120	135	150	165	180
L3	56.8	71.8	86.8	101.8	116.8	131.8	146.8	161.8	176.8	191.8
L4	73.5	88.5	103.5	118.5	133.5	148.5	163.5	178.5	193.5	208.5
L5	75	100	112.5	125	137.5	150	175	187.5	200	212.5
L6	85.5	110.5	123	135.5	148	160.5	185.5	198	210.5	223

#1 Common pilot pressure supply port is available for vacuum pump system or option L (Manifold individual supply specification). (mm: ø6 inch: ø1/4")

#2 Pump system with individual exhaust port type does not have exhaust port.

#3 When individual exhaust port type is selected (Body type: F)

#4 Only when common PD port type option (Symbol: -D) is selected (mm: ø6 inch: ø1/4")

#5 To fix the manifold to DIN rail, select an option for the manifold model number.

#6 Applicable connector: Connector for flat ribbon cable (26P)(MIL-C-83503 compliant)

#7 For complex exhaust type, air is also exhausted from the individual exhaust port of each station in addition to the common exhaust. (Ejector system)

Electrical Wiring Specifications

D-sub Connector

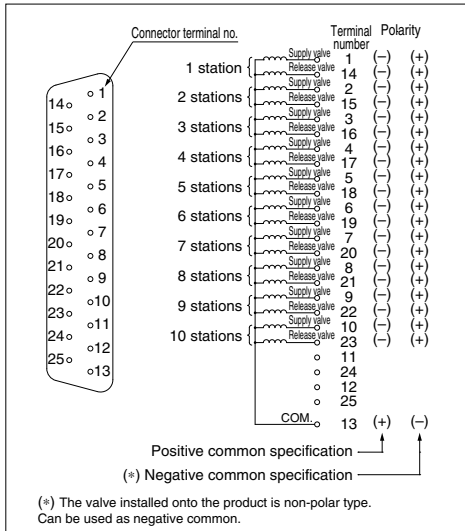

Flat Ribbon Cable Connector

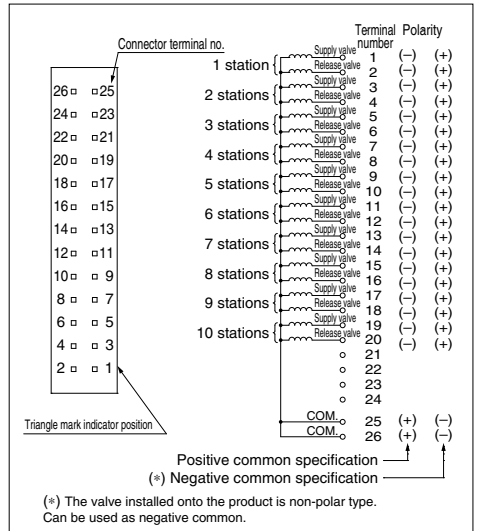

A D-sub connector (25P) conforming to MIL standards is used.

A flat ribbon cable connector (26P) conforming to MIL standards is used.

Optional Specifications/Functions/Applications

Symbol	Type	Image	Function/Application
B	With one bracket for mounting a single unit (Mounting screw is attached.)	Bracket	• Use when a single unit is mounted to the floor in an upright position is requested. (When ordering only bracket, refer to page 87.)
C	Pump system PE port female thread specification	PE port	• Use for pilot pressure exhaust piping (Standard pump system is released to the atmosphere.)
D	With individual release pressure supply (PD) port	PD port	• Use when supply pressure for vacuum release which pressure is different from the ejector supply pressure is requested.
J	Vacuum break flow adjusting needle Round lock nut type	Vacuum break flow adjusting needle	• Thicker than standard hexagon type. More suitable for hand tightening. • Round lock nut improves operability when manifold, pump system, or exhaust port type is used.
K	Vacuum break flow adjusting needle Screwdriver operation type	Vacuum break flow adjusting needle	• Slotted type improves fine adjustment performance when manifold, pump system, or exhaust port type is used.
L	Manifold individual supply specification	Individual supply port	• Adjust the supply pressure individually for manifold in order to adjust the vacuum pressure reached by each ejector.
P	Manifold common release pressure supply specification		• When selecting "D" (with common release pressure supply (PD) port) for manifold option, supplying a pressure which is different from for common PV to common PD is requested.
W	With exhaust interference prevention valve	Exhaust interference prevention valve	• When ejectors are operated individually, exhausted air may flow backward from the V port of ejectors that are turned off. Exhaust interference prevention valve prevents backflow.

ZK2

ZQ

ZR

ZB

ZA

ZX

ZM

ZL

ZH

ZH

ZH-X267

ZHP

ZU

VQD-V

Cable Assembly

D-sub Connector

015
AXT100-DS25-030
050

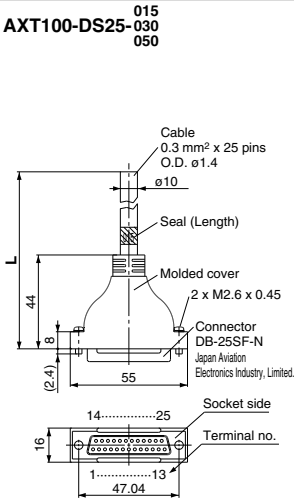

D-sub connector cable assembly
Wire Color by Terminal Number

Terminal number	Lead wire color	Dot marking
1	Black	None
2	Brown	None
3	Red	None
4	Orange	None
5	Yellow	None
6	Pink	None
7	Blue	None
8	Purple	White
9	Gray	Black
10	White	Black
11	White	Red
12	Yellow	Red
13	Orange	Red
14	Yellow	Black
15	Pink	Black
16	Blue	White
17	Purple	None
18	Gray	None
19	Orange	Black
20	Red	White
21	Brown	White
22	Pink	Red
23	Gray	Red
24	Black	White
25	White	None

D-sub Connector Cable Assembly (Option)

Cable length (L)	Assembly part number	Note
1.5 m	AXT100-DS25-015	Cable 0.3 mm ² x 25 cores
3 m	AXT100-DS25-030	
5 m	AXT100-DS25-050	

*For other commercial connectors, use a 25-pin type with female connector conforming to MIL-C-24308.
*Cannot be used for movable wiring.

Electrical Characteristics

Item	Property
Conductor resistance Ω/km, 20°C	65 or less
Voltage limit V, 1 min, AC	1000
Insulation resistance MΩ/km, 20°C	5 or more

Note) The minimum bending inner radius of D-sub connector cable is 20 mm.

Connector manufacturers' example

- Fujitsu Limited
- Japan Aviation Electronics Industry, Limited.
- J.S.T. Mfg. Co., Ltd.
- HIROSE ELECTRIC CO., LTD.

Flat Ribbon Cable Connector

1
AXT100-FC26-2
3

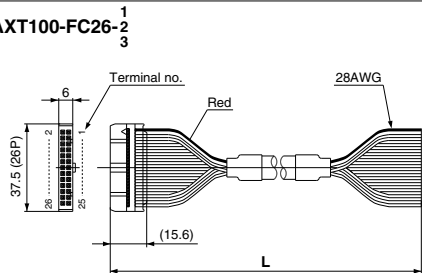

Flat Ribbon Cable Connector Assembly (Option)

Cable length (L)	Assembly part number
	26P
1.5 m	AXT100-FC26-1
3 m	AXT100-FC26-2
5 m	AXT100-FC26-3

*For other commercial connectors, use a 26-pin type with strain relief conforming to MIL-C-83503.
*Cannot be used for movable wiring.

Connector manufacturers' example

- HIROSE ELECTRIC CO., LTD.
- 3M Japan Limited
- Fujitsu Limited
- Japan Aviation Electronics Industry, Limited.
- J.S.T. Mfg. Co., Ltd.
- Oki Electric Cable Co., Ltd.

Specific Product Precautions 1

Be sure to read this before handling the products.

Refer to back page 50 for Safety Instructions and pages 49 to 51 for Vacuum Equipment Precautions.



Supply Valve / Release Valve

Warning

1. Manual override operation

- Manual override is non-locking push type. Push the manual override with a screwdriver of a diameter smaller than indicated in the diagram until it reaches the end.

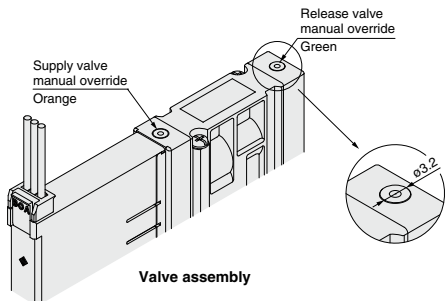

- Confirm that the product operates safely before the manual override is operated.

Note) When the linked type supply and release valves operation is selected, the supply valve can hold the position and will not switch off even if the supply valve manual override operation is finished unless the release valve manual override is pressed.

2. Self-holding function of supply valve

For valve assemblies where the supply and release valves are linked the supply valve is a self-holding type. Instantaneous energization (20 ms or more) of the supply valve allows the supply valve to hold. Continuous energization is not necessary. Energize the release valve to turn the supply valve off.

Note 1) Main valve in the valve assembly is made of elastic seal. Self-holding is performed by friction resistance of the seal. Do not apply impact resistance in the direction of the main valve shaft during the installation to moving parts. When the self-holding valve is applied with impact, energize it continuously, or use K type. (Refer to Combination of Supply Valve and Release Valve on pages 5 and 7.) (Vibration and impact should be 50 m/s² or less.)

Note 2) Self-holding type valve cannot use a digital switch for vacuum with energy saving function.

3. Default setting

When the valve assembly is delivered, the supply valve is on the OFF position, but it may be on the ON position due to the vibration or impact during transportation or device installation. Turn to the OFF position manually or by energizing before use.

Supply Valve / Release Valve

Warning

4. Wiring specifications and light/surge voltage suppressor

Wiring should be connected as shown below. Connect with the power supply respectively. (Solenoid valve is non-polar type.)

Single solenoid (Without release valve) Double solenoid (With release valve)

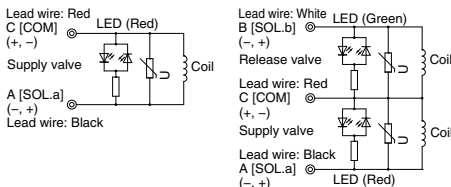

Light/surge voltage suppressor circuit is equipped for both single and double solenoid. Red LED turns on when supply valve (SOL.a) is energized. Green LED turns on when release valve (SOL.b) is energized.

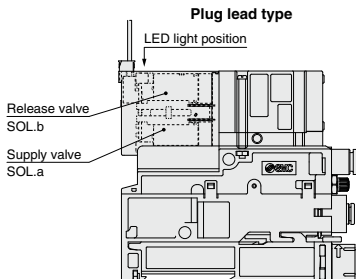
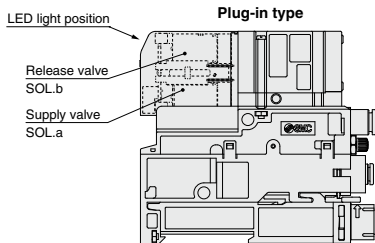

5. Continuous duty

If a supply valve/release valve is energized continuously for a long time, the rise in temperature due to heat-up of the coil may cause a decline in solenoid valve performance, reduce service life, or have adverse effects on peripheral equipment. When the energizing time per day is longer than non-energizing time, use self-holding linked type valve using instantaneous energizing.

ZK2

ZQ

ZR

ZB

ZA

ZX

ZM

ZL

ZH

ZH

ZH
-X267

ZHP

ZU

VQD-V



ZK2 Series

Specific Product Precautions 2

Be sure to read this before handling the products.

Refer to back page 50 for Safety Instructions and pages 49 to 51 for Vacuum Equipment Precautions.

Surge Voltage Intrusion

⚠ Caution

The surge voltage created when the power supply is cut off could apply to the de-energized load equipment through the output circuit. In cases where the energized load equipment has a larger capacity (power consumption) and is connected to the same power supply as the product, the surge voltage could malfunction and/or damage the internal circuit element of the product and the internal device of the output equipment. To avoid this situation, place an diode which can suppress the surge voltage between the COM lines of the load equipment and output equipment.

Plug Connector

⚠ Caution

1. Installation/Removal of connector

- To install the connector, hold the cover and insert the connector straight pushing the connector lever with your finger. Ensure that the connector lever clip is properly inserted onto mating part.
- To remove the connector, hold the cover and pull out the connector straight pushing the connector lever clip.

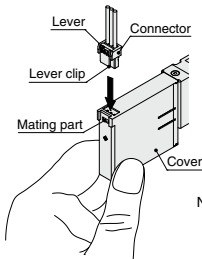

Note) Do not pull the lead wire with a force of 25 N or more, as this may damage the connector or cover.

2. Part number of connector assembly and lead wire length

The standard lead wire length for the connector assembly is 300 mm. For other lengths, refer to the table below.

ZK2-LVS□-A Connector assembly for single (For with supply valve, no release valve)

ZK2-LVW□-A Connector assembly for double (For with both supply valve and release valve)

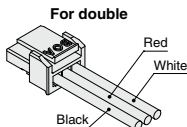
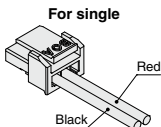

Nil	300 mm
6	600 mm
10	1000 mm
20	2000 mm
30	3000 mm

Note) When ordering, put the connector assembly part number to the product part number without connector.

Suction Filter

⚠ Caution

1. Replacement procedure for filter element

- To pull out the vacuum port adapter, rotate the adapter by about 90 degrees in direction A and pull in direction B. The adapter can be removed with the suction filter from the filter case.
- Remove the suction filter from the vacuum port adapter and replace it with a new suction filter.

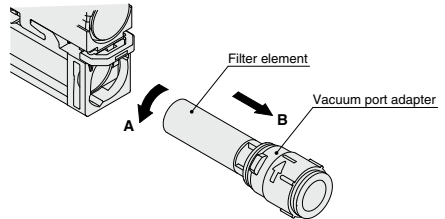

- When installing the filter, insert the filter to the end so that there is no gap or bending between the filter and the vacuum port adapter. The gap or bending will cause the element to deform inside the case.

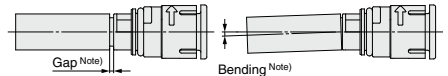

- Put the filter back into the filter case following this procedure in reverse.
- To mount the vacuum port adapter into the filter case, turn the adapter so that the mating mark of the adapter and the case are aligned. (Rotation stops there.)

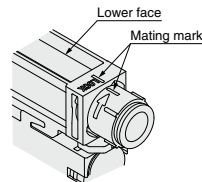

- If it is difficult to remove the vacuum port adapter, you can remove the adapter with a hexagon wrench using the hexagonal hole in V port. The table shows the port size and the width across flats.

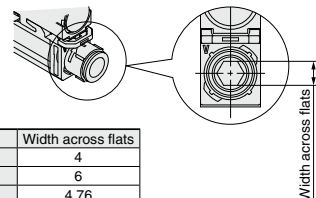

V port size	Width across flats
ø6	4
ø8, ø5/16"	6
ø1/4"	4.76



ZK2 Series

Specific Product Precautions 3

Be sure to read this before handling the products.

Refer to back page 50 for Safety Instructions and pages 49 to 51 for Vacuum Equipment Precautions.

Suction Filter

⚠ Caution

2. Filter case maintenance

- When the filter case is dirty, it can be removed and cleaned.

To remove the filter case, insert a precision screwdriver into the groove of the release lever and push in direction (①), and slide the filter case in direction (②).

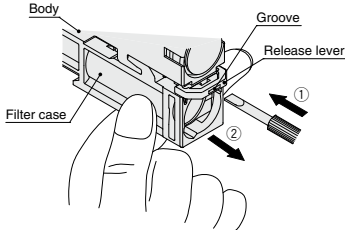

Note) Surface A of the filter case is the sealing surface when vacuum is generated. Handle with care so that the surface is not scratched or damaged.

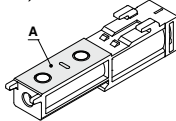

Note) Filter case is made of polycarbonate. Avoid chemicals such as thinner, carbon tetrachloride, chloroform, acetic ester, aniline, cyclohexane, trichloroethylene, sulfuric acid, lactic acid, water base cutting fluid (alkaline).

Note) Do not expose the filter case to direct sunlight for a long period of time.

- Put the filter case back into the ejector by the following procedure.

1) Make sure that body gasket (B) and the check valve are installed correctly onto the ejector. If they are out of the place, vacuum leakage may occur. In addition, pressure switches with the energy-saving function come equipped with 2 check valves.

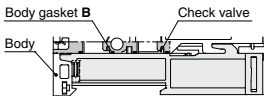

2) Push the filter case in direction (①). Be careful the filter case hook (A) and hook (B) do not touch the body of the ejector.

3) Slide the filter case in direction (②) while pushing the filter case gently in contact with the ejector. Make sure that the clip (C) is locked and there is no gap in part (D).

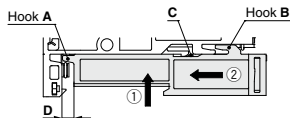

Note) If excess force is applied to the filter case, hook A and B may break. Handle with care.

Ejector Exhaust

⚠ Caution

- The exhaust resistance should be as small as possible to obtain the full ejector performance. There should be no shield around the exhaust slit for silencer exhaust type. When the product is installed, one of the ports should be open to atmosphere.

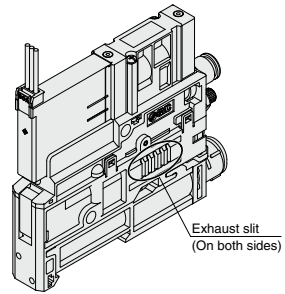

For port exhaust type, back pressure may increase depending on the piping size and length. Ensure that the back pressure does not exceed 0.005 MPa (5 kPa).

In addition, the exhaust port should not be blocked or pressurized.

- If the sound absorbing material is clogged, it will cause a reduction in the ejector performance. Sometimes, if the operating environment contains a lot of particles or mist, the replacement of the filter element only is not enough to recover vacuum performance - as the sound absorbing material may be clogged. Replace the sound absorbing material. (Regular replacement of the filter element and sound absorbing material is recommended.)

Replacement Procedure for Sound Absorbing Material (for Silencer Exhaust)

- Remove the filter case following the procedure of filter case maintenance.
- Flip the ejector, push the release lever again with a finger or precision screwdriver until the release lever stops.

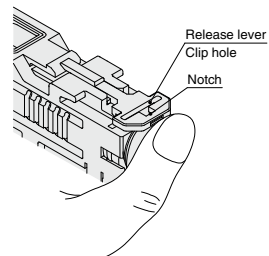

ZK2

ZQ

ZR

ZB

ZA

ZX

ZM

ZL

ZH

ZH

ZH

X-267

ZHP

ZU

VQD-V



ZK2 Series

Specific Product Precautions 4

Be sure to read this before handling the products.

Refer to back page 50 for Safety Instructions and pages 49 to 51 for Vacuum Equipment Precautions.

Ejector Exhaust

⚠ Caution

- 3) To remove the clip that holds the port plug, insert a precision screwdriver from the release lever notch. Move the screwdriver in direction (1) to pull out the clip in direction (2).

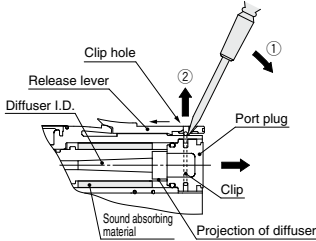

- 4) Remove the port plug. Slide back the release lever.
- 5) Remove the sound absorbing material from the slit (hole) at the side of the body by using a precision screwdriver.
- 6) Insert the new sound absorbing material. Be careful not to scratch the material with the projection of the diffuser assembly.

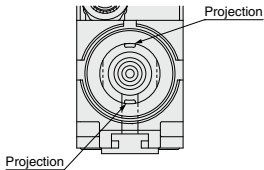

Diffuser hole viewed from the port plug

(Procedure to put parts back together)

- 7) Insert the port plug.
- 8) Push the release lever until it stops. Insert the clip into the groove using the lever hole. (Push completely to the end.)

Note) Do not pull or bend the two projections at the end surface of the diffuser. These are spacers to prevent the displacement of the diffuser and they may break if force is applied.

Replacement Procedure for High-noise Reduction Silencer Case Assembly

⚠ Caution

Refer to the replacement procedure of the sound absorbing material (silencer exhaust) to replace the assembly.

Note) When a high-noise reduction silencer case assembly is attached to body type "A" (silencer exhaust), the silencing effect cannot be acquired.

When only replacing the sound absorbing material (for high-noise reduction silencer exhaust)

- 1) Use the notch to remove the cap.
- 2) Use a precision screwdriver to remove the sound absorbing material.
- 3) Insert the new sound absorbing material, and return the cap.

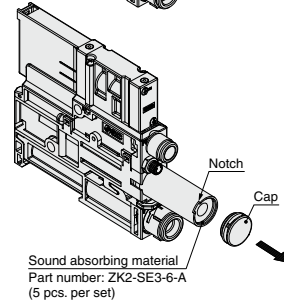
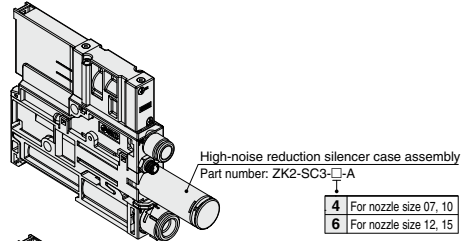

Operating Supply Pressure

⚠ Caution

- Use the product within the specified supply pressure range. Operation over the maximum operating pressure can cause damage to the product. The parts around the vacuum port of this product are designed to be used with vacuum pressure. With the vacuum pump system, since air is not released to the atmosphere from a silencer, the applied air for vacuum release increases the internal pressure of the vacuum port. Select the vacuum pad which shape allows smooth exhaust of release air to the atmosphere and avoid clogging.

Supply air containing foreign matter, moisture, oil content, drain, etc. can cause a malfunction. Refer to the Air Preparation Equipment Selection Guide in Best Pneumatics No. 6 (page 2) and use supply air of a quality equal to or higher than compressed air purity class "2:6:3" as stipulated by the ISO 8573-1:2010 (JIS B 8392-1:2012) standard. Flush the piping sufficiently to remove foreign matter before piping the product.

Specific Product Precautions 5

Be sure to read this before handling the products.

Refer to back page 50 for Safety Instructions and pages 49 to 51 for Vacuum Equipment Precautions.



Exhaust Noise

⚠ Caution

- When vacuum ejector generates vacuum, noise can be heard from the exhaust port when the standard supply pressure is close to the pressure that generates peak vacuum pressure making vacuum pressure unstable. If the vacuum pressure range is adequate for adsorption, there should not be a problem. If the noise causes a problem or affects the setting of the pressure switch, change the supply pressure slightly to avoid the pressure range of the noise.

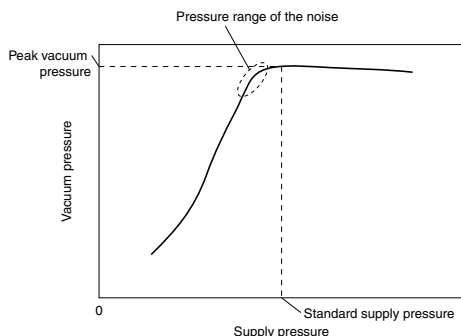

Port Size of Single Unit

⚠ Caution

- Port size

Port	Size			
	Ejector System		Vacuum Pump System	
	Metric	Inch	Metric	Inch
PV	ø6	ø1/4"	ø6	ø1/4"
V	ø6, ø8	ø1/4", ø5/16"	ø6, ø8	ø1/4", ø5/16"
EXH (Port exhaust)	ø8	ø5/16"	—	—
PE	EXH Common		Port open to atmosphere *1)	
PS	—	—	ø4	ø5/32"
PD *2)	M3	—	M3	—

— : Not applicable

*1) Piping for PE port is available as an option (M3). (Refer to page 63.)

*2) A model with PD port is available as an option. (Refer to pages 61 and 63.)

How to Mount a Single Unit

⚠ Caution

1. Single unit can be mounted to DIN rail or wall using the holes in the body (2 x ø4.5).

- When mounting the ejector to DIN rail, unlock the filter case assembly beforehand. (Refer to the maintenance procedure on page 95.)
- Hook the ejector onto the DIN rail from direction (①).
- Mount the ejector onto the DIN rail by pushing it down in direction (②).
- Push the filter case assembly in direction (③) until it is locked.

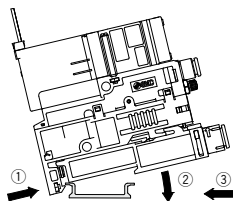

- To hold the ejector onto the DIN rail, hold it from both sides using the stopper brackets.

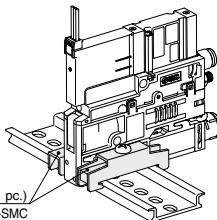

2. To mount a single unit onto the floor, use the optional bracket.

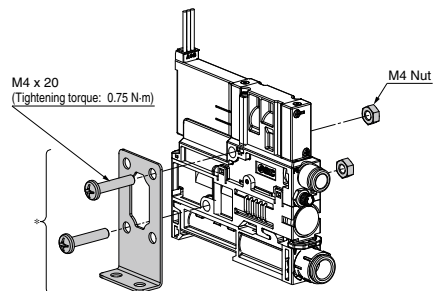

*Mounting bracket for single unit (Option), [Nuts and bolts are included.]
Part number: ZK2-BK1-A

ZK2

ZQ

ZR

ZB

ZA

ZX

ZM

ZL

ZH

ZH

ZH
-X267

ZHP

ZU

VQD-V

ZK2 Series

Specific Product Precautions 6

Be sure to read this before handling the products.

Refer to back page 50 for Safety Instructions and pages 49 to 51 for Vacuum Equipment Precautions.



How to Mount a Manifold

⚠ Caution

- Manifolds can be mounted onto the floor using M4 holes on the end plate.
- It is possible to mount the manifold onto the DIN rail by manifold option.
 - Hook the mounting bracket of the end plate to DIN rail from direction (1).
 - Mount the ejector onto the DIN rail by pushing it down in direction (2).
 - Use a 50 mm or longer Phillips screwdriver to tighten the mounting bracket (3). (Tightening torque: 0.9 ± 0.1 N·m)
 - Removal should be performed by following the mounting procedure in reverse.

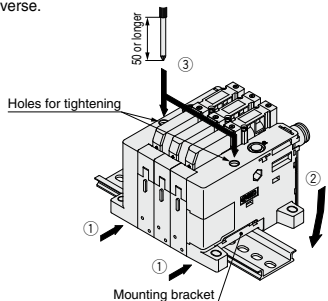

Manifold Silencer

⚠ Caution

- Ejector system manifold silencer common exhaust type has a sound absorbing material in the end plate. If the sound absorbing material is clogged, ejector performance is deteriorated, leading to suction failure or response delay. Regular replacement of the sound absorbing material is recommended.

Replacement Procedure

- Insert a precision screwdriver to notch (A) of the end plate and remove a clip (L) (1).
- Insert a precision screwdriver to notch (B) and remove the silencer cover (2).
- Pull out the sound absorbing material from the silencer cover (3).
- Mounting of a new element should be performed by following the removal procedure in reverse.

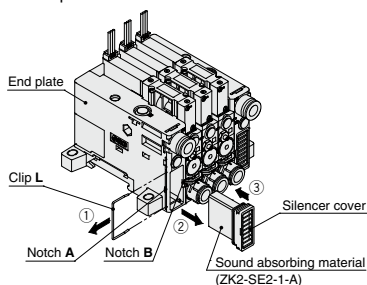

Manifold Ports

⚠ Caution

- Manifold ports are common at the end plate. Port description and application are the same as the single unit. (Refer to page 79 for application and operating pressure range of each port.)
- Refer to page 67 for the number of stations that can operate simultaneously for each ejector size.
- If one side is not used for air supply, plug the unused port or change to the dedicated port plug as shown below.

	Standard	Plug part number
Common PV port	ø8 One-touch	VVQZ2000-CP
Common PS port		
Common PD port	ø6 One-touch	ZK2-MP1C6-A

* There are 4 types depending on the manifold port specification.

	Common EXH port	Common PS/PD ports	Application
ZK2□-A□1□	Yes	PS = PD	Ejector common exhaust + PV = PS = PD specification
ZK2□-A□1□-D	Yes	PS ≠ PD	Ejector common exhaust + PV = PS ≠ PD specification
ZK2□-A□2□ ZK2□-P2□	None	PS = PD	Ejector individual exhaust + PV = PS = PD Pump system + PV ≠ PS = PD
ZK2□-A□2□-D ZK2□-P2□-D	None	PS ≠ PD	Ejector individual exhaust + PV = PS ≠ PD Pump system + PV ≠ PS ≠ PD

- When PS = PD, the common PS/PD ports on the end plate are used, PS port is equipped with One-touch fitting and PD port is plugged at the time of shipment from the factory. Since the PS and PD are connected inside the end plate, common supply location can be changed by exchanging the One-touch fitting and the plug.
- When PS ≠ PD, PS and PD are not connected inside the end plate. (It is necessary to supply each port individually.)

Vacuum Break Flow Adjusting Needle

⚠ Caution

- The flow rate characteristics show the representative values of the product itself.**

They may change depending on piping, circuit and pressure conditions, etc. The flow rate characteristics and the number of needle rotations vary due to the range of the specifications of the product.
- The needle has a retaining mechanism, so it will not turn further when it reaches the rotation stop position.**

Turning the needle too far may cause damage.
- Do not tighten the handle with tools such as nippers.**

This can result in breakage due to idle turning.
- Do not over tighten the lock nut.**

It is possible to tighten the standard lock nut (hexagon) manually. When tightening further with tools, tighten by approximately 15° to 30°. Over tightening may cause breakage.
- When screwdriver operation type needle is selected as option (-K), make sure the lock nut is not loose to prevent the nut from coming off due to vibration.**



ZK2 Series

Specific Product Precautions 7

Be sure to read this before handling the products.

Refer to back page 50 for Safety Instructions and pages 49 to 51 for Vacuum Equipment Precautions.

■ Handling of Pressure Sensor Assembly

Handling

⚠ Caution

1. Do not drop, bump or apply excessive impact (980 m/s²) when handling.

Even if the sensor body is not damaged, the internal parts may get damaged, leading to malfunction.

2. The tensile strength of the power cord is within 50 N, and pulling it with a greater force can cause failure.

Hold the body when handling the product.

3. Refer to the Operation Manual of the pressure sensor PSE540 series for how to connect the connectors for sensor.

Environment

⚠ Caution

1. The use of resin piping can cause static electricity to be generated, depending on the fluid.

Therefore, when connecting this sensor, take appropriate measures against static electricity at the equipment side to which this product is mounted, and separate the grounding for the product from the grounding for any equipment which generates a strong electromagnetic noise or high frequency. Otherwise, static electricity can break the sensor.

■ Handling of Pressure Switch for Vacuum Assembly

Handling

⚠ Caution

1. Do not drop, bump or apply excessive impact (100 m/s²) when handling.

Even if the sensor body is not damaged, the internal parts may get damaged, leading to malfunction.

2. The tensile strength of the power cord is within 35 N, and pulling it with a greater force can cause failure.

Hold the body when handling the product.

3. Do not allow repeated bending or stretching forces to be applied to lead wires.

Wiring arrangements in which repeated bending stress or stretching force is applied to the lead wires can cause broken wires.

If the lead wire can move, fix it near the body of the product. The recommended bending radius of the lead wire is 6 times the outside diameter of the sheath, or 33 times the outside diameter of the insulation material, whichever is larger. Replace the damaged lead wire with a new one. For details, please consult with SMC.

■ Handling of Pressure Switch for Vacuum Assembly

Handling

⚠ Caution

1. Incorrect wiring can cause the switch to be damaged or malfunction. Connections should only be made when the power supply is turned off.

2. Do not attempt to insert or pull out the connector from the switch while the power is on.

Otherwise, it may cause switch output malfunction.

3. Malfunctions stemming from noise may occur if the wire is installed in the same route as that of power or high-voltage cable.

Wire the switch independently.

4. Be sure to ground the frame ground (FG) terminal when using a commercially available switching power supply.

Environment

⚠ Warning

1. The structure of pressure switches is not intended to prevent explosion.

Never use in an atmosphere of flammable gas or explosive gas.

⚠ Caution

1. The product is CE marked, but not immune to lightning strikes.

Take measures against lightning strikes in your system.

2. Do not use the switches in locations where static electricity would be problematic.

Otherwise, it may result in the system failure and trouble.

Assembling / Removing Connectors

⚠ Caution

- When assembling the connector to the switch housing, push the connector straight onto the pins until the level locks into the housing slot.

- When removing the connector from the switch housing, push the section A (lever) down with your thumb to unlock it from the slot and then withdraw the connector straight off of the pins.

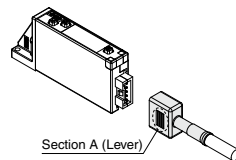

- Do not attempt to insert or pull out the connector from the switch while the power is on. Otherwise, it may cause switch output malfunction.

ZK2
ZQ
ZR
ZB
ZA
ZX
ZM
ZL
ZH
ZH
ZH-X267
ZHP
ZU
VQD-V



ZK2 Series

Specific Product Precautions 8

Be sure to read this before handling the products.

Refer to back page 50 for Safety Instructions and pages 49 to 51 for Vacuum Equipment Precautions.

■ Handling of Digital Pressure Switch with Energy Saving Function

Mounting

Caution

1. Tighten to the specified tightening torque.

If the tightening torque is exceeded, the mounting screws and the pressure switch may break. Insufficient torque may cause displacement of the pressure switch and loosening of the mounting screws.

Tightening torque: 0.08 to 0.10 N·m

2. Be sure to ground the frame ground (FG) terminal when using a commercially available switching power supply.

3. Do not drop, hit or apply shock to the product.

Otherwise, the internal parts of the pressure switch may get damaged and cause malfunction.

4. Do not pull the lead wire with force, or lift the product by pulling the lead wire. (Tensile strength within 20 N)

Hold the product body when handling to prevent damage, failure or malfunction. Otherwise, the pressure switch will be damaged, leading to failure and malfunction.

5. Eliminate any dust left in the piping by using a blast of air before connecting the piping to the product.

Otherwise, failure or malfunction may occur.

6. Do not insert metal wires or other foreign matter into the pressure port.

Otherwise, the pressure sensor may get damaged, leading to failure and malfunction.

7. If the fluid contains foreign matter, install and connect a filter or mist separator to the inlet.

Otherwise, failure, malfunction or inaccurate measurements from the pressure switch may occur.

Other Tube Brands

Caution

1. When tubing of brands other than SMC's are used, verify that the tubing O.D. satisfies the following accuracy;

1) Nylon tubing: Within ± 0.1 mm

2) Soft nylon tubing: Within ± 0.1 mm

3) Polyurethane tubing: Within $+0.15$ mm, within -0.2 mm

Do not use tubing which does not meet these outside diameter tolerances.

It may not be possible to connect them, or they may cause other trouble, such as air leakage or the tube pulling out after connection.

Vacuum Ejector

Supply valve: N.O. specification

Can hold vacuum*¹ even when the power goes out or is turned off

Prevents the sudden dropping of workpieces*¹

*¹ Supposing the supply pressure is being maintained

Vacuum ejector with energy-saving function

90% Air consumption reduction*²

*² Based on SMC's measuring conditions

The digital pressure switch for vacuum with energy-saving function cuts supply air when the pressure reaches the desired vacuum.

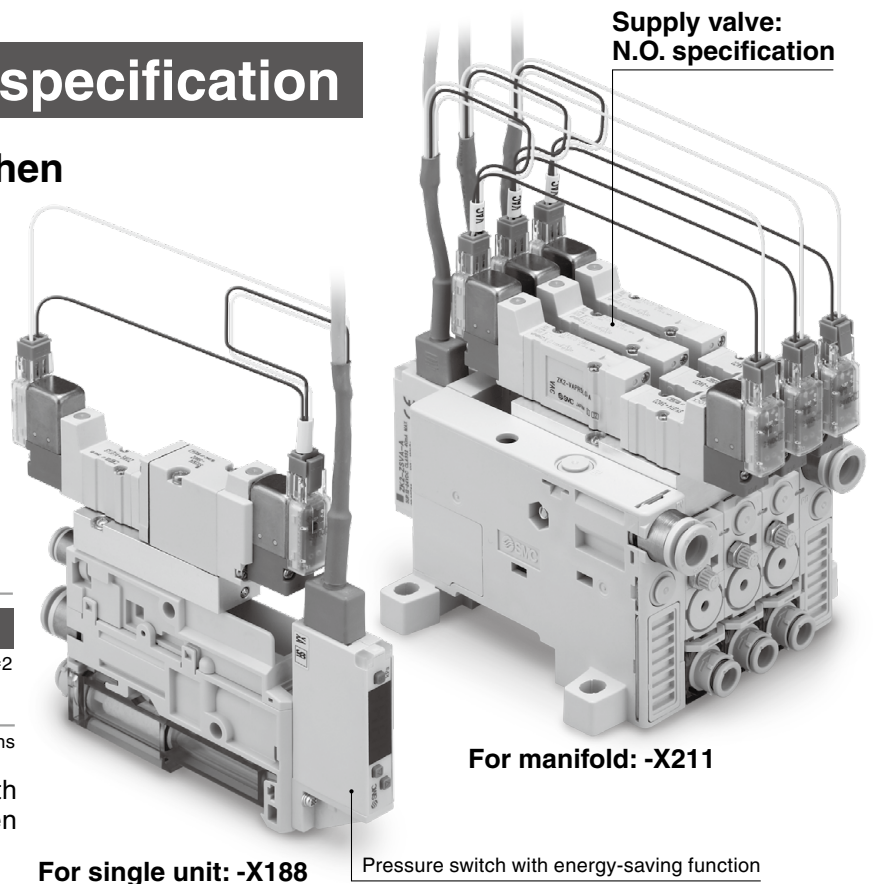

For single unit: -X188

For manifold: -X211

Pressure switch with energy-saving function

● Typical Operation Pattern

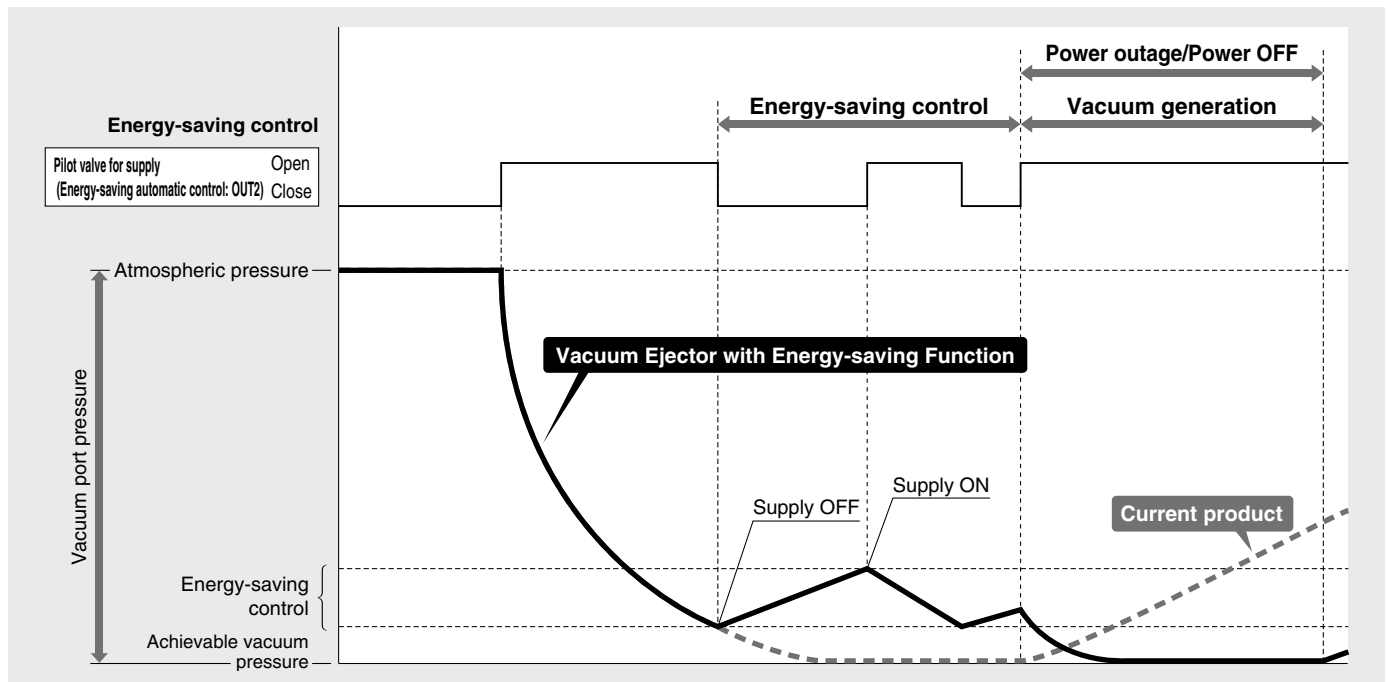

ZK2□-X188: For Single Unit
ZK2□-X211: For Manifold



Vacuum Ejector with Energy-saving Function

ZK2□-X188

ZK2□-X211

How to Order Single Unit

Single unit

ZK2 **A** **12** **A** **5** **MO** **Z** **K** **W** - **06** - □ - X188

For manifold

ZK2 **C** **12** **A** **5** **MO** **Z** **K** **W** - **06** - □ - X211

①

②

③

④

⑤

⑥

(Refer to page 2 for How to Order Manifold.)

Supply valve: N.O./Release valve: N.C.

• With light/surge voltage suppressor

Rated voltage*4: 24 VDC

• M plug connector, Without connector

*4 Rated voltage for the supply and release valve

① System/Body type

Symbol	System	Body type	Exhaust type	Built-in silencer
A	Ejector system	Single unit	Silencer exhaust	
B			Port exhaust*1	
G			High-noise reduction silencer exhaust	
C		For manifold	Complex exhaust*2	
F			Individual port exhaust*1	
H			High-noise reduction silencer exhaust	

*1 Port size: ø8 (mm), ø5/16" (inch)

*2 The complex exhaust method combines the common exhaust from the end plate and the direct exhaust from each station.

④ Digital pressure switch for vacuum connector specifications

Symbol	Lead wire with connector for pressure switch	
L3	None	
W	With lead wire for switch with energy-saving function	

⑤ Vacuum (V) port*7

Symbol	Type	Port size
06	Metric size	ø6 One-touch fitting
08		ø8 One-touch fitting
07	Inch size	ø1/4" One-touch fitting
09		ø5/16" One-touch fitting

*7 Supply port (PV) size of single unit: ø6 (mm), ø1/4" (inch)

② Nominal nozzle size

Symbol	System	Nominal size
07	Ejector system*3	ø0.7
10		ø1.0
12		ø1.2
15		ø1.5

*3 Standard supply pressure for nozzle size
07 to 12: 0.35 MPa
15: 0.4 MPa (ZK2□-X188)
0.45 MPa (ZK2□-X211)

③ Digital pressure switch for vacuum specifications

Symbol	Type	Pressure range [kPa]	Specifications
K	Digital pressure switch for vacuum with energy-saving function	-100 to 100	NPN 1 output
Q			Unit selection function*5
R			SI unit only*6
S			Unit selection function*5
S			SI unit only*6

*5 The unit selection function is not available in Japan due to the New Measurement Act.

*6 Fixed unit: kPa

⑥ Optional specifications (Single unit)*8

Symbol	Type
Nil	Without option
B	With one bracket for mounting a single unit (Mounting screws are attached.)
D	With individual release pressure supply (PD) port*9
E	Long lock nut specification: Screwdriver operation type*10
J	Vacuum break flow-adjusting needle: Round lock nut type
K	Vacuum break flow-adjusting needle: Screwdriver operation type

*8 When more than one option is selected, list the option symbols in alphabetical order. Example) -BJ

Refer to the **Web Catalog** for Function/Application.

*9 Only M3 is available for the PD port size. Use a One-touch fitting or barb fitting (M-3AU-4) for piping. (O.D.: Within ø6.2)

*10 Combinations of "EJ," "EK," and "EJK" are not available.

⑥ Optional specifications (For manifold)*11, *12

Symbol	Type
Nil	Without option
E	Long lock nut specification: Screwdriver operation type
J	Vacuum break flow-adjusting needle: Round lock nut type
K	Vacuum break flow-adjusting needle: Screwdriver operation type
L	Manifold individual supply specification*13
P	With common release pressure supply (PD) port*14

*11 When more than one option is selected, list the option symbols in alphabetical order. Example) -JK

*12 For ① System/Body type "F" or "H," when "L" is selected for ⑥ Optional specifications, the vacuum break flow-adjusting needle option "E," "K," or "JK" can be additionally selected for increased workability.

*13 Select the body for the manifold. Select "L" for the manifold type. When the common supply and individual supply are mixed, please contact SMC.

*14 When "-D" is selected as a manifold option, select option "-P" for the single unit model number.

* Combinations of "EJ," "EK," and "EJK" are not available.

Vacuum Ejector with Energy-saving Function **ZK2□-X188/ZK2□-X211**

How to Order Manifold

ZK2 04 - A 1 **L** - - **X211**

1
 2
 3
 4

Individual wiring specification

1 Stations

Symbol	Stations
01	1 station
⋮	⋮
10	10 stations

2 System (Port combination)

Symbol	System	Port	Standard
A	Ejector system	Common PV: $\phi 8$	Metric size
AN	system	Common PV: $\phi 5/16$ "	Inch size

3 Exhaust

Symbol	Type
1	Ejector system: Complex exhaust*1, *3
2	Ejector system: Individual exhaust*2 (Individual port exhaust, High-noise reduction silencer exhaust)

- *1 Select "C" for 1 System/Body type for the single unit model number. Air is exhausted not only from the end plate but also from the exhaust of each station.
- *2 Select "F" or "H" for 1 System/Body type for the single unit model number.
- *3 The complex exhaust method combines the common exhaust from the end plate and the direct exhaust from each station.

4 Option*4

Symbol	Type
Nil	Without option
B	With DIN rail mounting bracket*5
D	With common release pressure supply (PD) port*6
L	Manifold individual supply specification*7

- *4 When more than one option is selected, list the option symbols in alphabetical order.
- *5 Select "B" for DIN rail mounting.
- *6 When "-D" is selected for the manifold model number, select option "-P" for the ejector system single unit model number.
- *7 When "-L (individual supply)" is selected for 6 Optional specifications for the single unit model number, specify "-L" for the manifold, too.
- * A combination of "DL" is not available.

How to Order Valve Manifold Assembly

Example

ZK2C12A5MOZQW-08-X211

ZK2C10A5MOZQW-08-X211

ZK204-A1L-B-X211

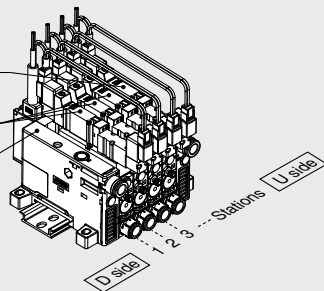

ZK204-A1L-B-X211 1 set (Manifold part number)
 * ZK2C10A5MOZQW-08-X211 3 sets (Nominal nozzle size: $\phi 1.0$)
 * ZK2C12A5MOZQW-08-X211 1 set (Nominal nozzle size: $\phi 1.2$)
 ↳ The asterisk denotes the symbol for the assembly.
 Prefix to the single unit part number.

- When the manifold is viewed from the V port, the first station starts from the left (D side).
- After the manifold part number, specify the installed single unit from the first station.
- Complex exhaust and individual port exhaust cannot be mixed.
- The DIN rail should be ordered separately. (Refer to the ZK2 series in the **Web Catalog**.)
- * Some of the units can be replaced by single units for the standard manifold. (Note that single units for manifold ZK2□-X211 cannot be used for the standard manifold.)

Valve Specifications

	Supply valve		Release valve
	ZK2□-X188	ZK2□-X211	
Solenoid valve model	SYJ524-5MOZ-Q	SYJ325-5MOZ-Q	SYJ314-5MOZ-Q
Type of actuation	N.O.		N.C.
Operating pressure range	0.15 MPa to 0.6 MPa		
Rated voltage	24 VDC		
Power consumption	0.4 W		

Ejector Specifications

Item	Model	ZK2□07-X188	ZK2□10-X188	ZK2□12-X188	ZK2□15-X188
		ZK2□07-X211	ZK2□10-X211	ZK2□12-X211	ZK2□15-X211
Nozzle diameter	[mm]	0.7	1.0	1.2	1.5
Max. suction flow*1	Port exhaust	[L/min (ANR)]	34	56	74
	Silencer exhaust/Complex exhaust	[L/min (ANR)]	29	44	61
	High-noise reduction silencer exhaust	[L/min (ANR)]	34	56	72
Air consumption*1	[L/min (ANR)]	24	40	58	90
Maximum vacuum pressure*1	[kPa]	-91			
Supply pressure range	[MPa]	0.15 to 0.6			
Standard supply pressure	[MPa]	0.35			0.4 (For X188)
					0.45 (For X211)

*1 Values are based on SMC's measurement standards. They depend on atmospheric pressure (weather, altitude, etc.) and the measurement method.

Manifold Weight

	1 station	2 stations	3 stations	4 stations	5 stations	6 stations	7 stations	8 stations	9 stations	10 stations
Weight [g]	345	560	780	1000	1215	1435	1650	1875	2100	2320

Single unit weight: 200 g (With vacuum pressure switch)

Specifications not listed are the same as those of the standard product. For details, refer to the **Web Catalog**.

ZK2□-X188/ZK2□-X211

Wiring Examples

For digital pressure switch for vacuum specifications: K, Q

For digital pressure switch for vacuum specifications: R, S

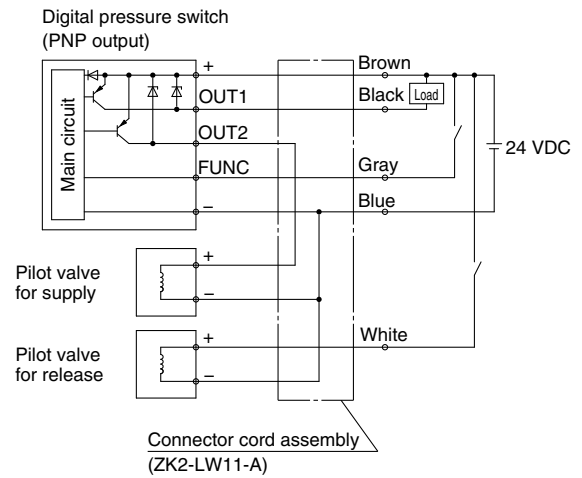
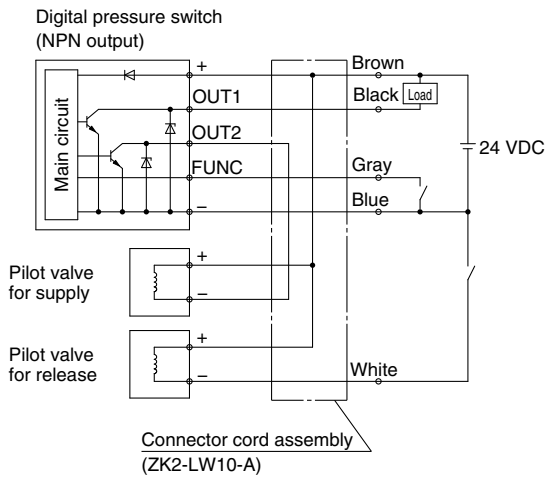

Timing Chart (Typical operation pattern)

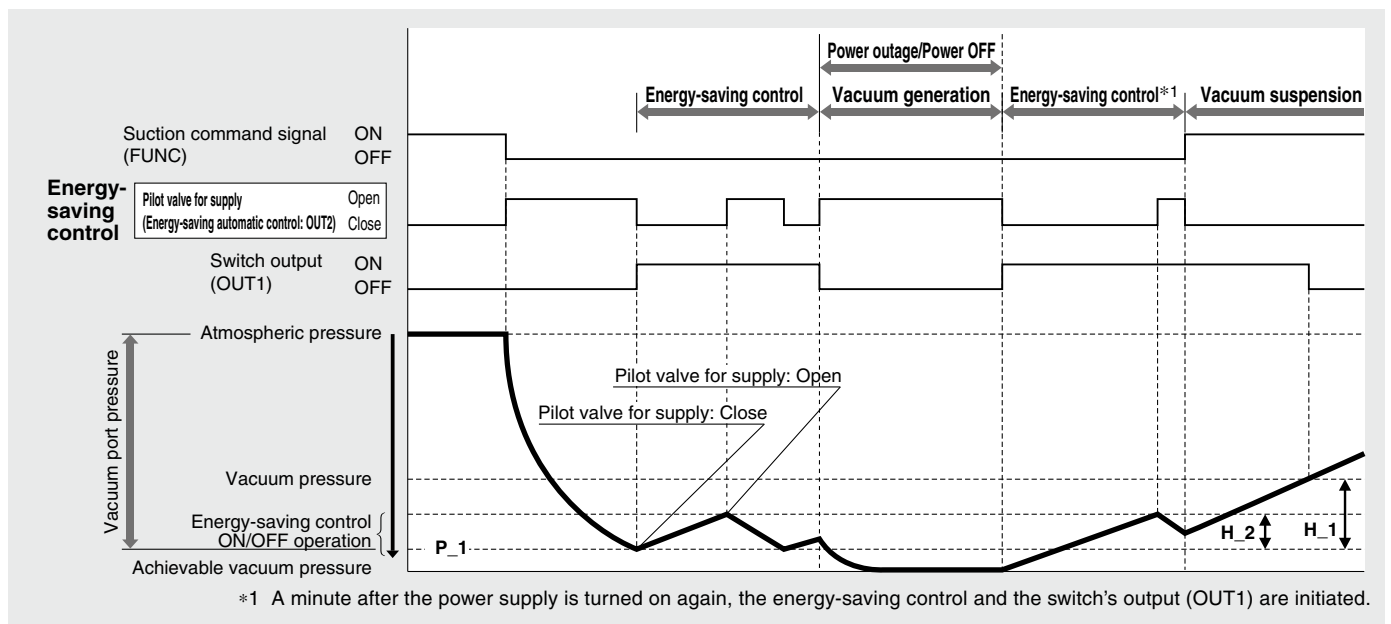

Port Layout

-X188

Port layout no. **1**

Single unit: ZK2A□A5MOZ□□-□-□-X188

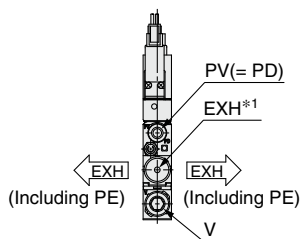

System	Ejector	
Body type	Single unit	
Exhaust type	Silencer exhaust	
Application and purpose	Vacuum pressure	—
	Exhaust	Released within the operating environment
	Release pressure	Same pressure as PV

Port combination: PV = PD

Circuit example

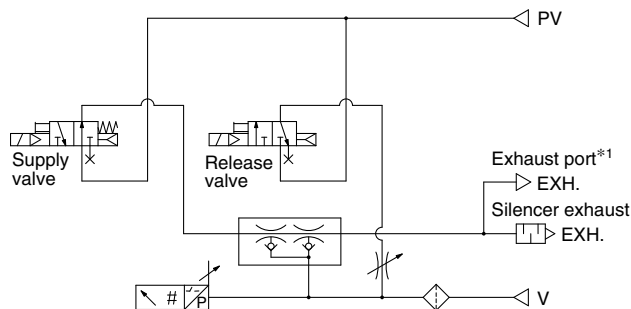

*1 Nozzle size: 12, 15

Port layout no. **2**

Single unit: ZK2B□A5MOZ□□-□-□-X188

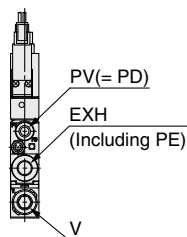

System	Ejector	
Body type	Single unit	
Exhaust type	Port exhaust	
Application and purpose	Vacuum pressure	—
	Exhaust	Released within the operating environment
	Release pressure	Same pressure as PV

Port combination: PV = PD

Circuit example

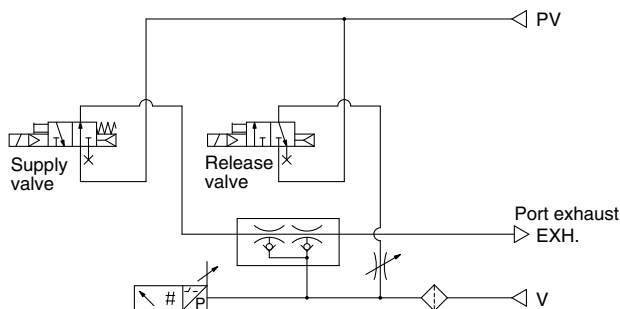

Port layout no. **3**

Single unit: ZK2G□A5MOZ□□-□-□-X188

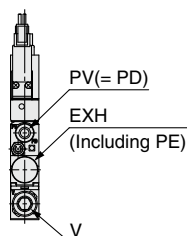

System	Ejector	
Body type	Single unit	
Exhaust type	High-noise reduction silencer exhaust	
Application and purpose	Vacuum pressure	—
	Exhaust	Released within the operating environment
	Release pressure	Same pressure as PV

Port combination: PV = PD

Circuit example

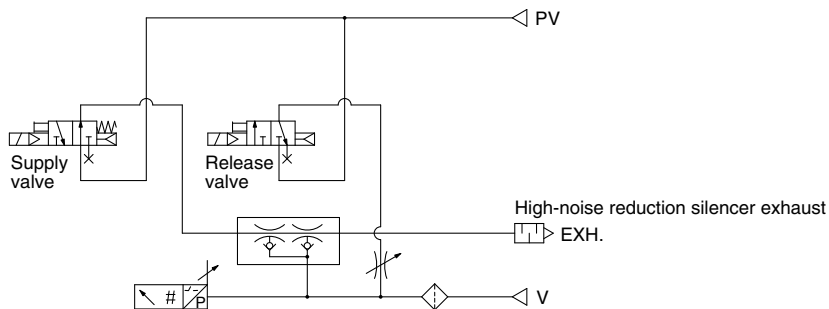

ZK2□-X188/ZK2□-X211

Port Layout

Option -D

Port layout no. 10

Single unit: ZK2C□A5MOZ□□-□-□P-X211
Manifold: ZZK2□□-A□1L-□D-X211

*1 The complex exhaust method combines the common exhaust from the end plate and the direct exhaust from each station.

System	Ejector
Body type	Manifold
Exhaust type	Complex exhaust*1
Application and purpose	Vacuum pressure: Common for each station
	Exhaust: Released within the operating environment
	Release pressure: Common PD pressure has to be supplied with common PV.

Port combination: Common PV ≠ Common PD **Circuit example**

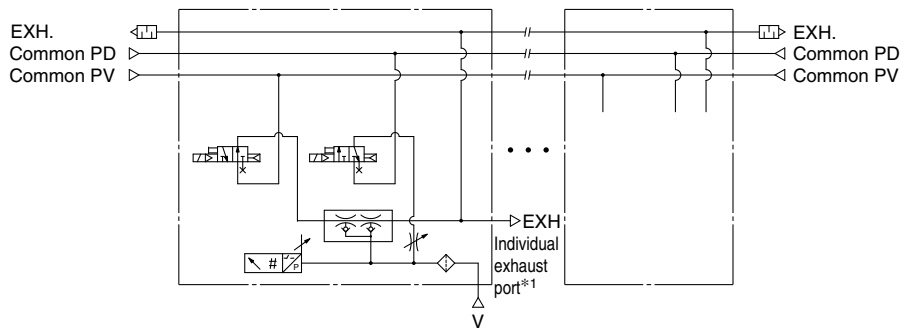

*1 For the complex exhaust type, an individual exhaust port is provided to each station.

Port layout no. 11

Single unit: ZK2F□A5MOZ□□-□-□P-X211
Manifold: ZZK2□□-A□2L-□D-X211

System	Ejector
Body type	Manifold
Exhaust type	Individual port exhaust
Application and purpose	Vacuum pressure: Common for each station
	Exhaust: After piping, individual exhaust is necessary.
	Release pressure: Common PD pressure has to be supplied with common PV.

Port combination: Common PV ≠ Common PD **Circuit example**

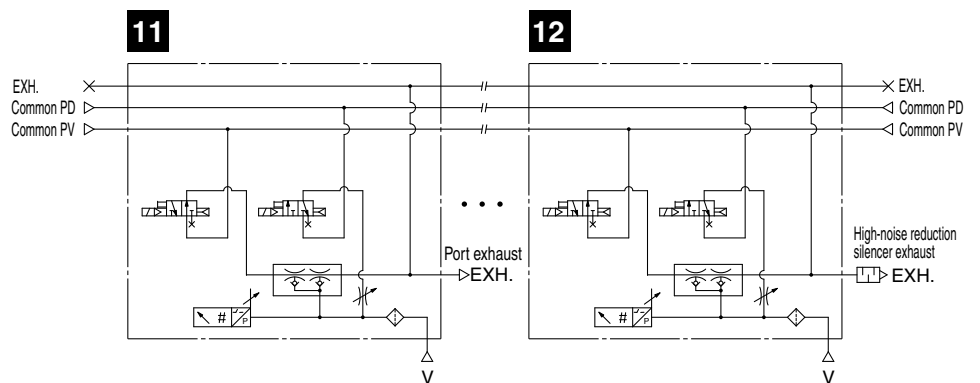

Port layout no. 12

Single unit: ZK2H□A5MOZ□□-□-□P-X211
Manifold: ZZK2□□-A□2L-□D-X211

System	Ejector
Body type	Manifold
Exhaust type	High-noise reduction silencer exhaust
Application and purpose	Vacuum pressure: Common for each station
	Exhaust: Released within the operating environment
	Release pressure: Common PD pressure has to be supplied with common PV.

Port Layout

Option -L

Port layout no. **13**

Single unit: ZK2C□A5MOZ□□-□-□-□L-X211
 Manifold: ZZK2□□-A□1L-□L-X211

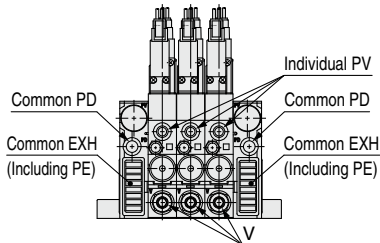

*1 The complex exhaust method combines the common exhaust from the end plate and the direct exhaust from each station.

System	Ejector	
Body type	Manifold	
Exhaust type	Complex exhaust*1	
Application and purpose	Vacuum pressure	PV pressure can be changed per station.
	Exhaust	Released within the operating environment
	Release pressure	Common PD pressure has to be supplied with individual PV.

Port combination: Individual PV ≠ Common PD

Circuit example

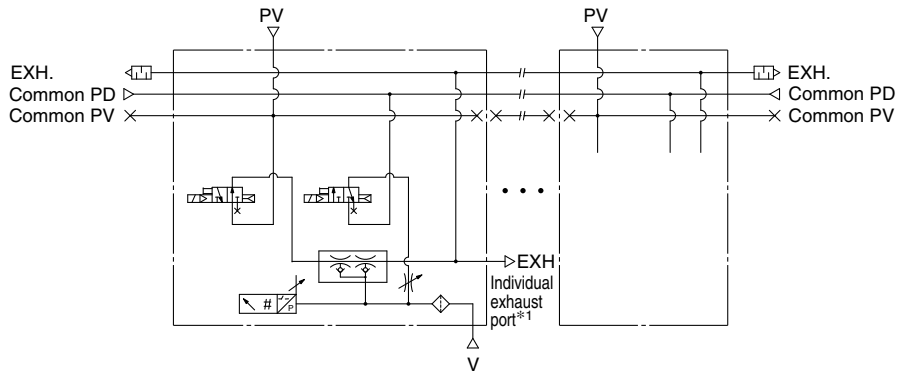

*1 For the complex exhaust type, an individual exhaust port is provided to each station.

Port layout no. **14**

Single unit: ZK2F□A5MOZ□□-□-□-□L-X211
 Manifold: ZZK2□□-A□2L-□L-X211

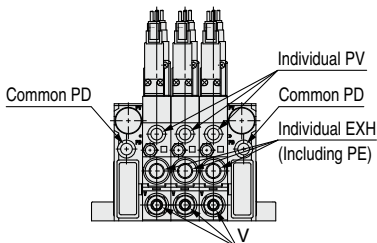

System	Ejector	
Body type	Manifold	
Exhaust type	Individual port exhaust	
Application and purpose	Vacuum pressure	PV pressure can be changed per station.
	Exhaust	After piping, individual exhaust is necessary.
	Release pressure	Common PD pressure has to be supplied with individual PV.

Port combination: Individual PV ≠ Common PD

Circuit example

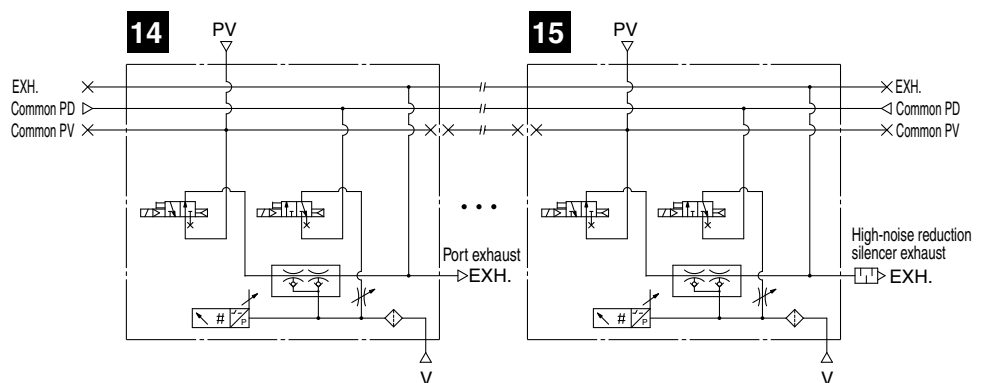

Port layout no. **15**

Single unit: ZK2H□A5MOZ□□-□-□-□L-X211
 Manifold: ZZK2□□-A□2L-□L-X211

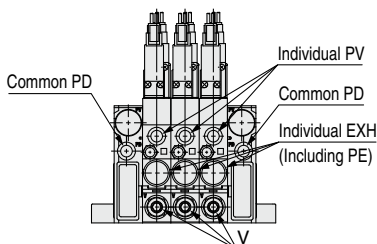

System	Ejector	
Body type	Manifold	
Exhaust type	High-noise reduction silencer exhaust	
Application and purpose	Vacuum pressure	PV pressure can be changed per station.
	Exhaust	Released within the operating environment
	Release pressure	Common PD pressure has to be supplied with individual PV.

ZK2□-X188/ZK2□-X211

Dimensions: Single Unit

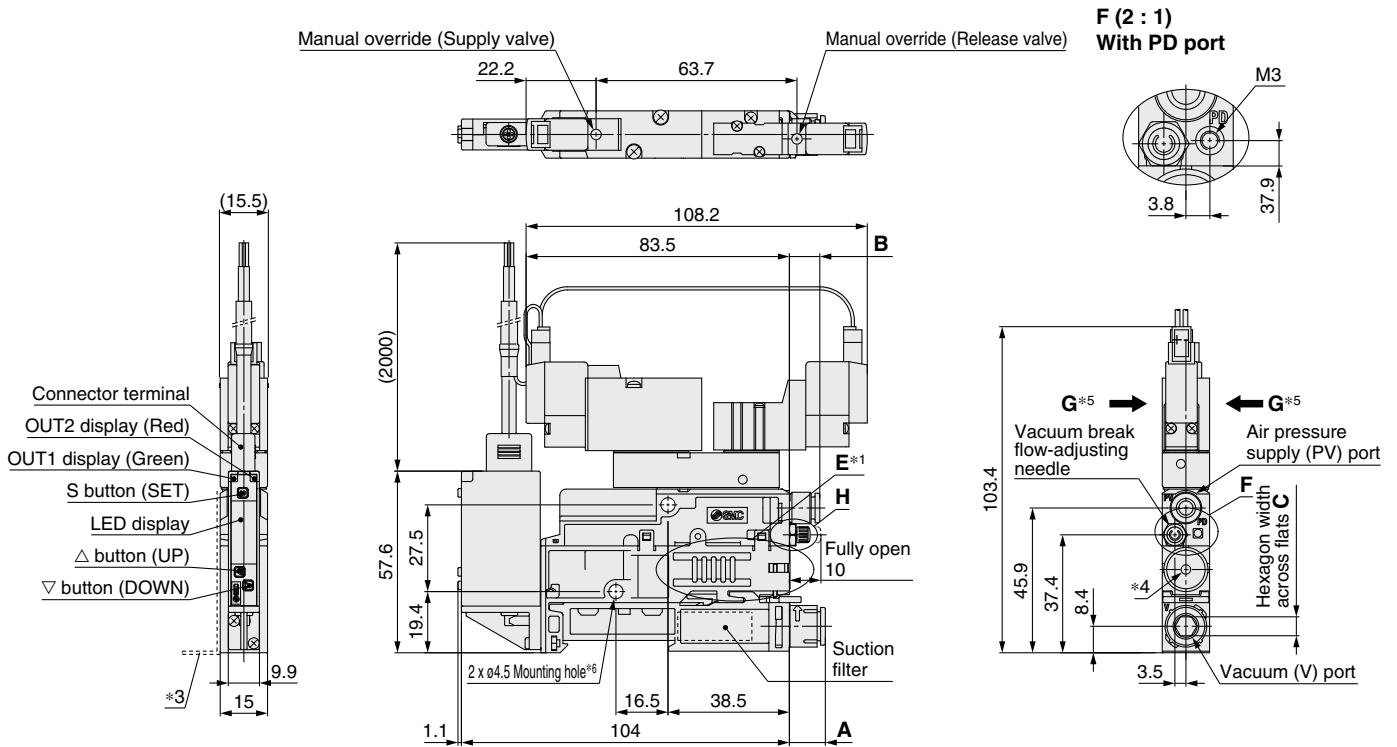

For high-noise reduction silencer exhaust
(Body type: G)

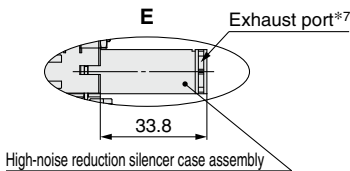

For port exhaust
(Body type: B)

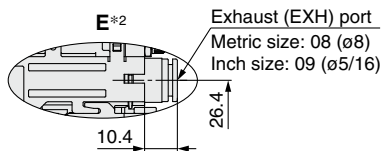

H (2 : 1)
ZK2□□A5MOZ□□-□□-□□E-X188

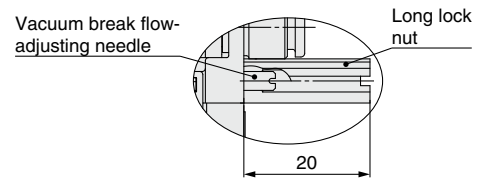

V Port Dimensions

V port type		A	B	C
Metric size	06	ø6	8.25	4
	08	ø8	11.4	6
Inch size	07	ø1/4"	10.8	4.76
	09	ø5/16"	11.4	6

*1 For the silencer exhaust type, air is exhausted from the slit on both sides. (Do not cover both sides. Allow release from at least one side.)

*2 For the port exhaust type, air is exhausted from the One-touch fitting.

*3 Refer to the **Web Catalog** for dimensions with a mounting bracket.

*4 Nozzle sizes 12 and 15 have an exhaust port.

*5 Do not apply any external force in the directions of the arrows shown beside G.

*6 When the product is mounted by using a 2 x ø4.5 mounting hole, it is recommended that the M4 screw be tightened with a tightening torque of 0.73 to 0.75 N·m.

*7 Do not block the exhaust port. Otherwise, backflow of exhausted air, which can cause the failure of the product, may occur.

* These figures show the ZK2A□A5MOZ□W-□□-□□X188.

Vacuum Ejector with Energy-saving Function **ZK2□-X188/ZK2□-X211**

Dimensions: Manifold

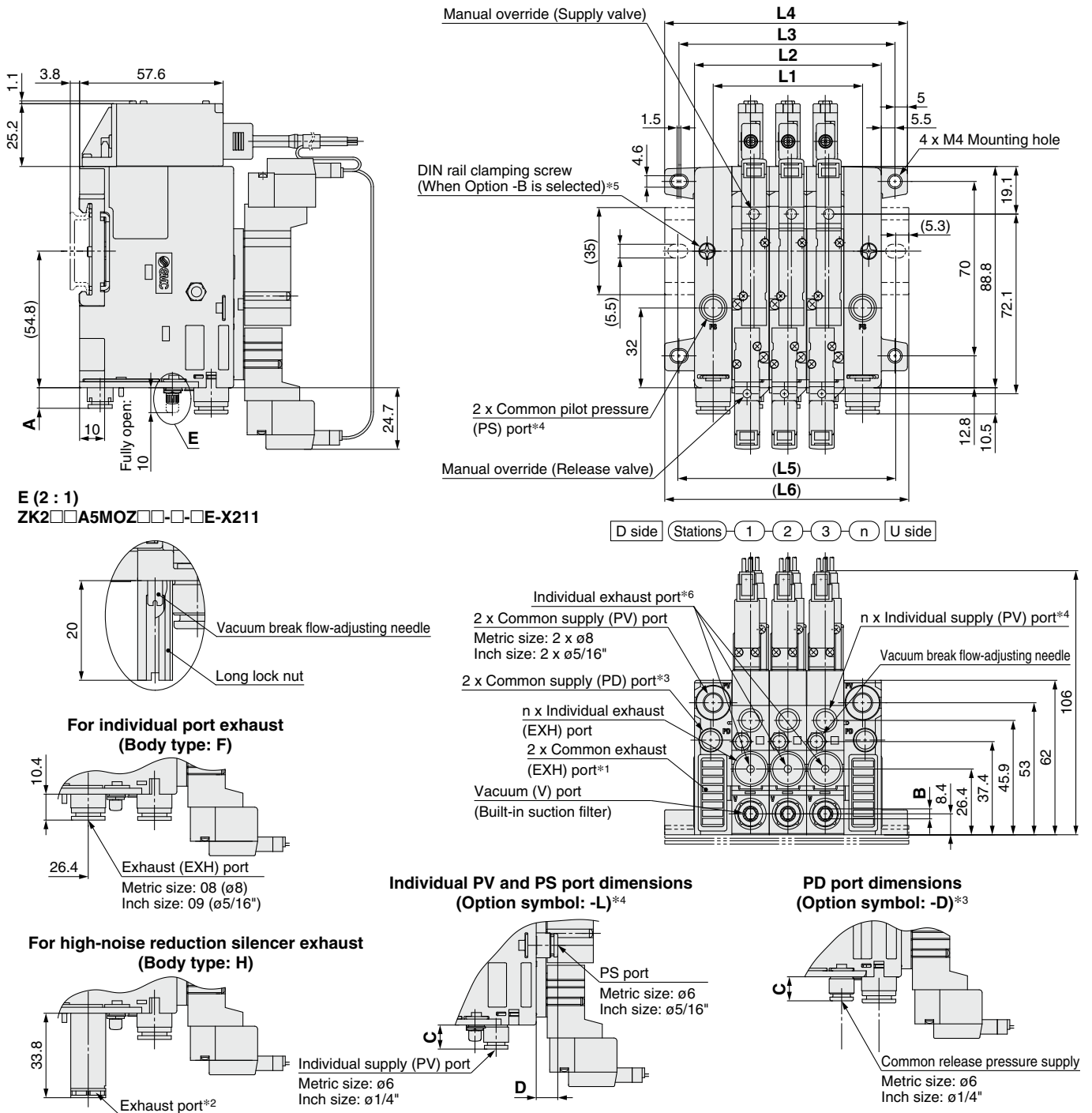

Port Dimensions

V port type	A	B	C	D
Metric size	06	08	9.7	8.7
Inch size	07	09	12.3	11.3

Manifold Dimensions

Stations	1	2	3	4	5	6	7	8	9	10
L1	30	45	60	75	90	105	120	135	150	165
L2	45	60	75	90	105	120	135	150	165	180
L3	56.8	71.8	86.8	101.8	116.8	131.8	146.8	161.8	176.8	191.8
L4	67.5	82.5	97.5	112.5	127.5	142.5	157.5	172.5	187.5	202.5
L5	62.5	75	87.5	100	112.5	125	137.5	150	162.5	175
L6	73	85.5	98	110.5	123	135.5	148	160.5	173	185.5

*1 The individual port exhaust type and high-noise reduction silencer exhaust type do not have exhaust ports.
 *2 Do not block the exhaust port. Otherwise, backflow of exhausted air, which can cause the failure of the product, may occur.
 *3 Only when common PD port type option (Symbol: -D) is selected (mm: ø6 inch: ø1/4")

*4 Only when the individual supply specification (Symbol: -L) is selected (mm: ø6 inch: ø1/4")
 *5 To secure the manifold to the DIN rail, select an option for the manifold model number.
 *6 For the complex exhaust type, air is also exhausted from the individual exhaust port of each station in addition to the common exhaust.

 **Safety Instructions** Be sure to read the "Handling Precautions for SMC Products" (M-E03-3) and "Operation Manual" before use.