

Gun Type Ionizer

New



Lighting LED

Reduced operating force

Easy to hold grip

Blow setting function p. 1

Select from continuous blow or pulse blow.

Trigger setting function p. 1

Trigger linked/Trigger lock/OFF timer can be selected.

Flow rate adjustment function p. 2

Flow adjustment valve with indicator enables handheld flow adjustment.

Rapid static neutralization
0.3 s^{*1}

*1 Distance: 150 mm,
Operating pressure: 0.2 MPa

IZG10 Series



CAT.ES100-134A

Blow and trigger setting can be selected.

1 Mode setting switch p. 9



Set no.	Blow setting	Trigger setting	
0	Continuous blow	Trigger linked	
1		Trigger lock	
2		OFF timer	3 s
3			5 s
4	7 s		
5	Pulse blow	Trigger linked	
6		Trigger lock	
7		OFF timer	3 s
8			5 s
9	7 s		

Selection of blow setting

Continuous blow

Blows ionized air continuously.



Pulse blow

Pulse blow saves air.

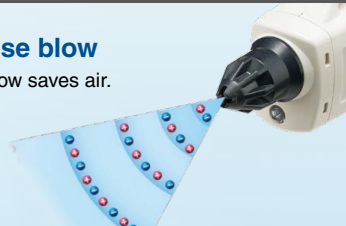

Selection of trigger setting

Trigger linked

Trigger ON/OFF and Blow ON/OFF are linked.

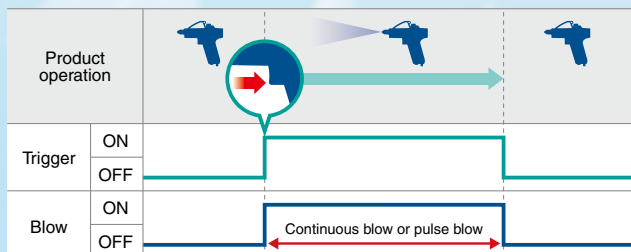

Trigger lock

Trigger operation turns Blow ON. Blow remains ON until another trigger input turns Blow OFF.

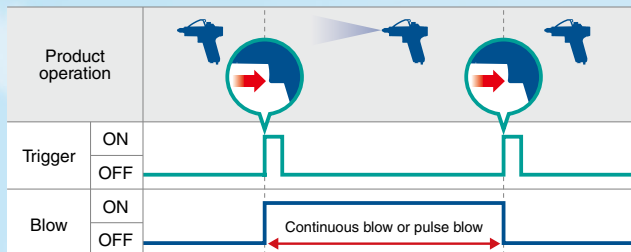

OFF timer

Trigger operation turns Blow ON. Blow remains ON for set time then automatically turns OFF.

Timer set time: 3 s, 5 s, 7 s

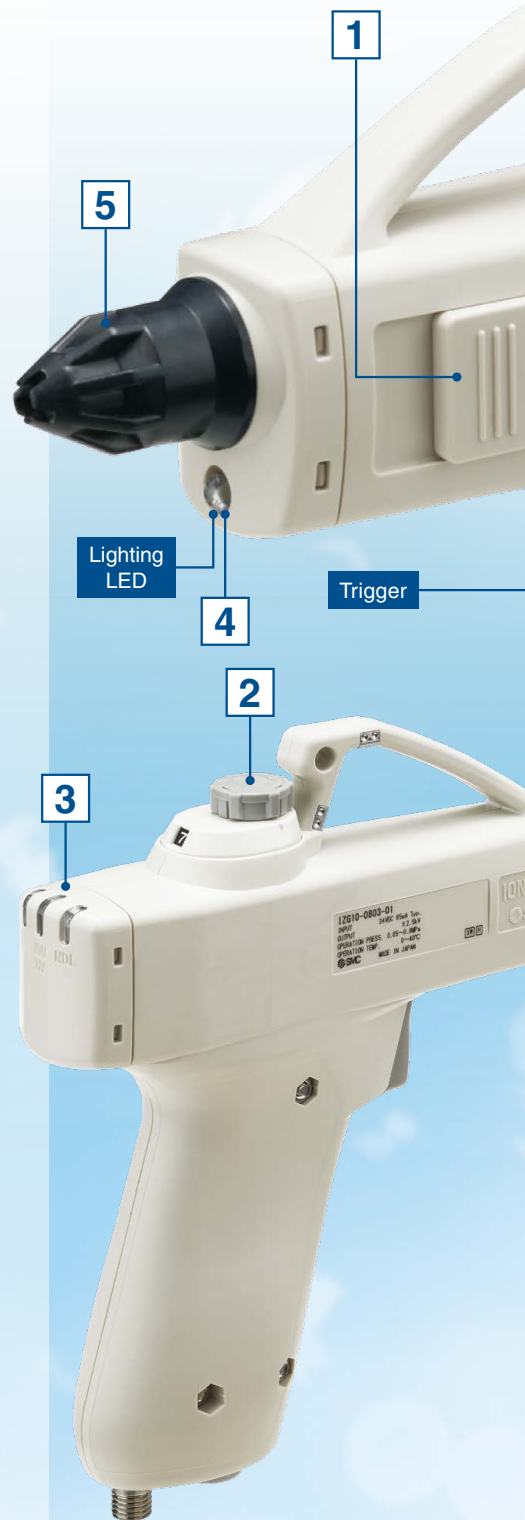
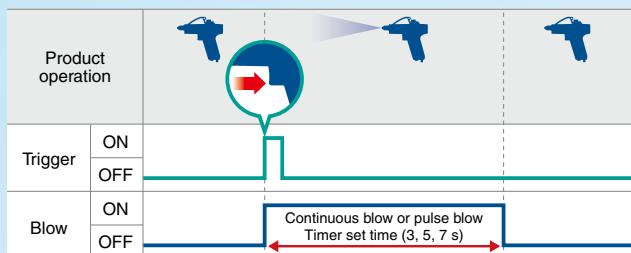



2 With flow adjustment valve (with indicator)



- Flow rate of ionized air can be adjusted on the gun.
- The flow rate can be controlled numerically.

Number of needle rotations	Flow rate [L/min (ANR)]
2	21
4	60
6	124
7	200

Supply pressure: 0.4 MPa

3 High visibility LEDs

Rear mounted LEDs are easy to see during operation.



Power ON

Ion generation



Maintenance indicator

Incorrect high voltage



Turns ON when lowered static neutralization performance due to the contamination, wear, or breakage of the emitter is detected.

Turns ON when a high voltage output error, such as emitter short circuit or abnormal discharge occurs.

4 Lighting LED

Easy to find particles on the workpiece



5 Easy cleaning and replacement of emitters

1 Removal of nozzle



2 Removal of emitter



Application Examples

For the static neutralization and dust removal of resin parts

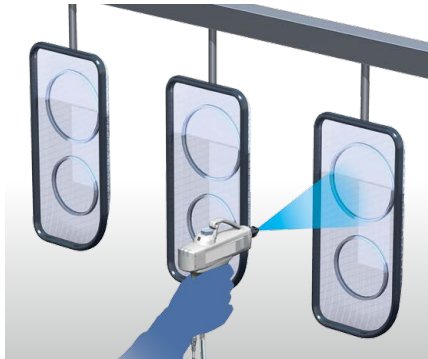

For the static neutralization and dust removal of resin parts

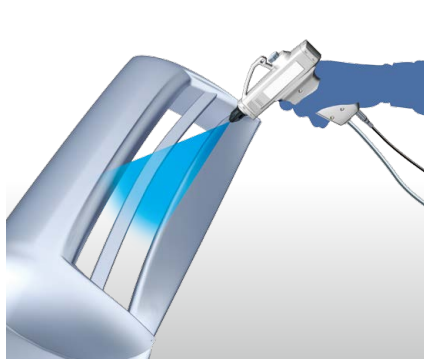

For the dust removal of resin products

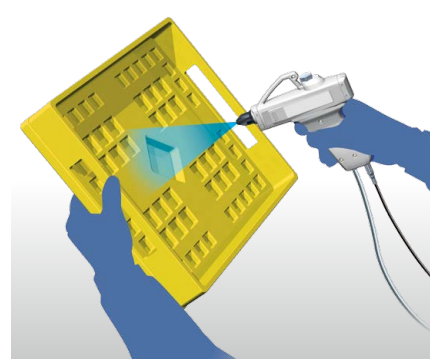

For the static neutralization and dust removal of electric substrates

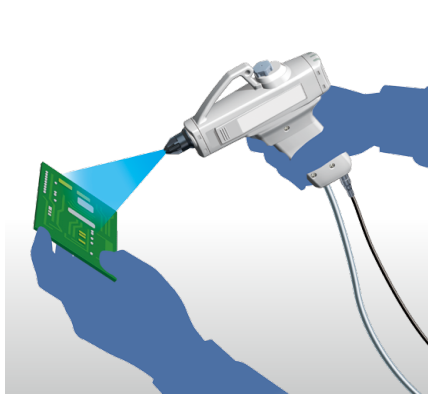

For the static neutralization and dust removal of resin parts with the ionizer suspended from above

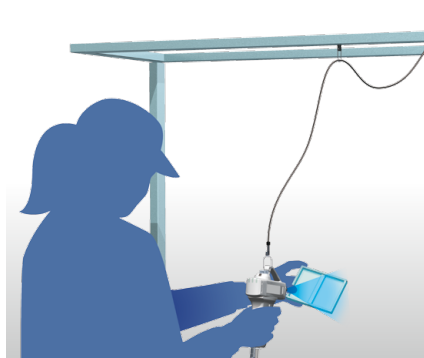

For the dust removal when detaching from film

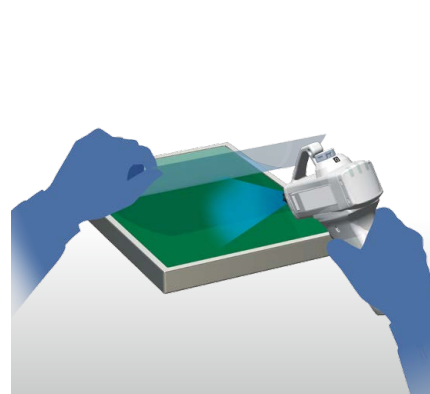

CONTENTS

Gun Type Ionizer *IZG10 Series*



Technical Data: Static Neutralization Characteristics

① Installation Distance and Discharge Time	p. 4
② Static Neutralization Range	p. 5
③ Pressure — Flow Rate Characteristics	p. 6
How to Order	p. 7
Accessories (for Individual Parts)	p. 7
Specifications	p. 8
AC Adapter Specifications	p. 8
Parts Description	p. 8

Description of LED Indicators	p. 8
Alarm	p. 8
Mode Switch Setting	p. 9
Wiring	p. 9
Dimensions	p. 10
Related Products	p. 11
Specific Product Precautions	p. 12
Safety Instructions	Back cover

IZG10 Series Technical Data

* Static neutralization characteristics are based on data using a charged plate (dimensions: 150 mm x 150 mm, capacitance: 20 pF) as defined in the U.S. ANSI standards (ANSI/ESD STM3.1-2015). Use this data only as a guideline for model selection because the values vary depending on the material and/or size of the subject.

Static Neutralization Characteristics

① Installation Distance and Discharge Time (Discharge Time from 1000 V to 100 V)

Mode setting switch: Continuous blow

1) Number of needle rotations [2]

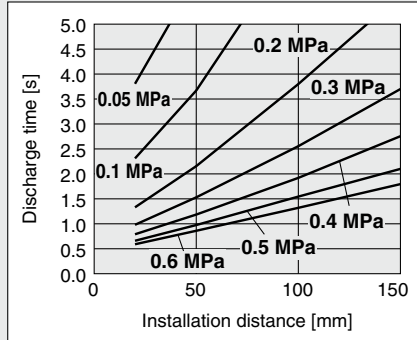

2) Number of needle rotations [4]

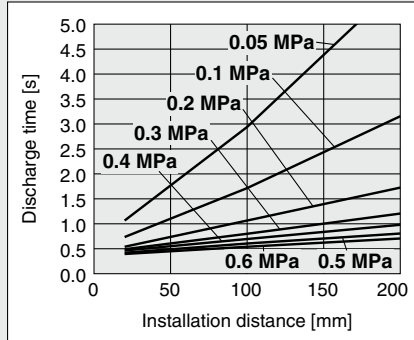

3) Number of needle rotations [6]

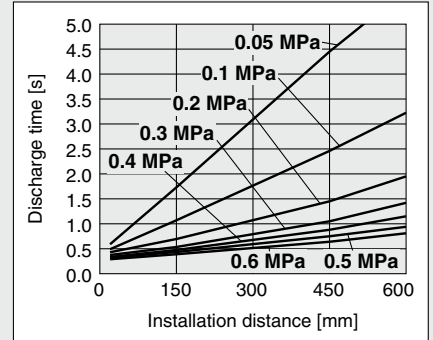

4) Number of needle rotations [Max.]

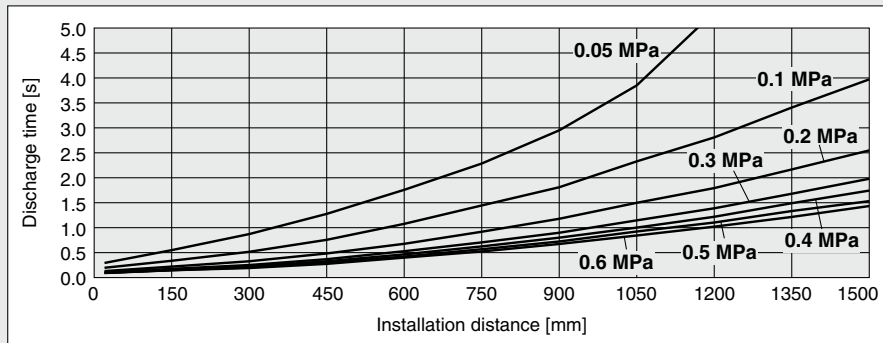

Mode setting switch: Pulse blow

5) Number of needle rotations [2]

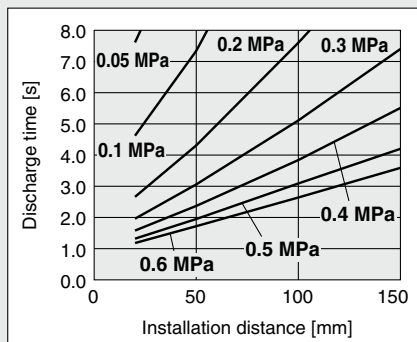

6) Number of needle rotations [4]

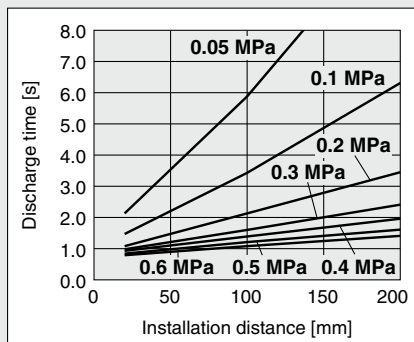

7) Number of needle rotations [6]

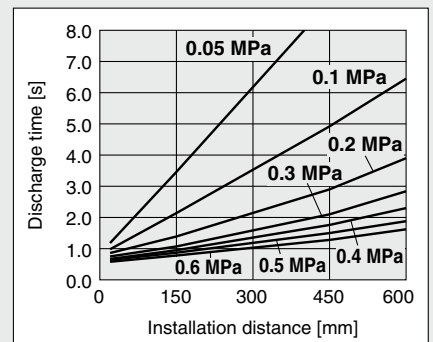

8) Number of needle rotations [Max.]

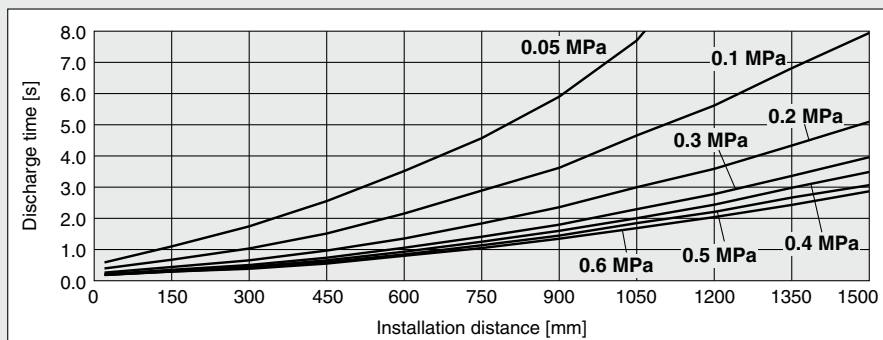

* Static neutralization characteristics are based on data using a charged plate (dimensions: 150 mm x 150 mm, capacitance: 20 pF) as defined in the U.S. ANSI standards (ANSI/ESD STM3.1-2015). Use this data only as a guideline for model selection because the values vary depending on the material and/or size of the subject.

Static Neutralization Characteristics

② Static Neutralization Range (Discharge Time from 1000 V to 100 V)

Mode setting switch: Continuous blow, Number of needle rotations [Max.]

1) Supply pressure: 0.05 MPa Flow rate consumption: 80 L/min (ANR)

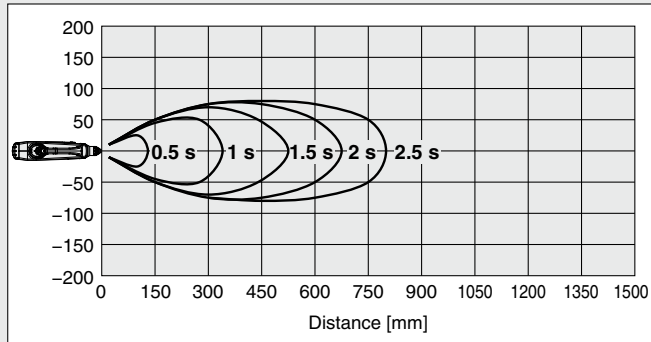

2) Supply pressure: 0.1 MPa Flow rate consumption: 119 L/min (ANR)

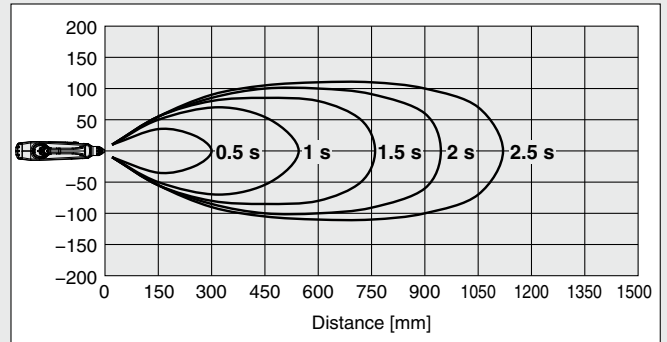

3) Supply pressure: 0.2 MPa Flow rate consumption: 188 L/min (ANR)

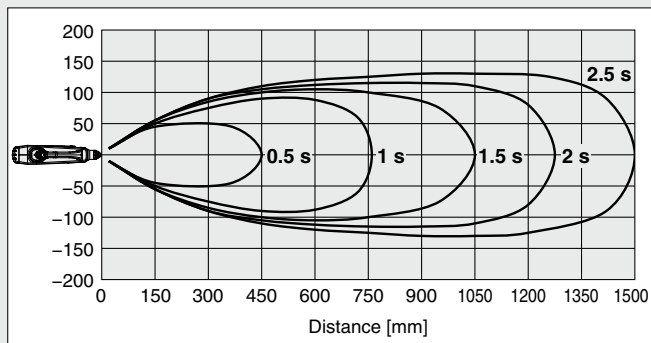

4) Supply pressure: 0.3 MPa Flow rate consumption: 253 L/min (ANR)

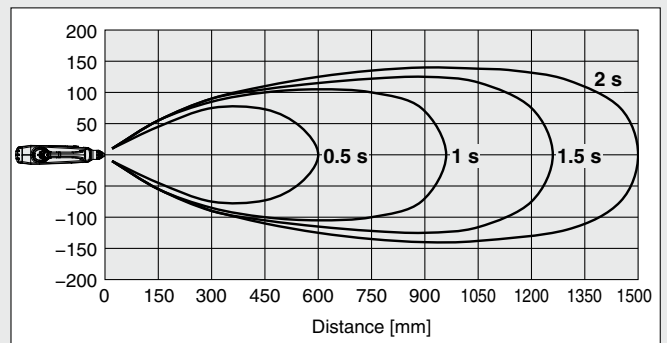

5) Supply pressure: 0.4 MPa Flow rate consumption: 316 L/min (ANR)

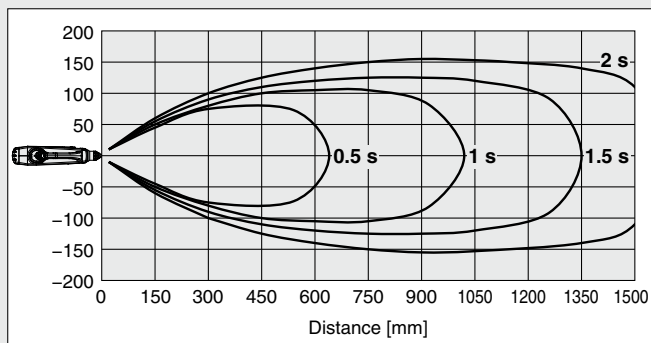

6) Supply pressure: 0.5 MPa Flow rate consumption: 390 L/min (ANR)

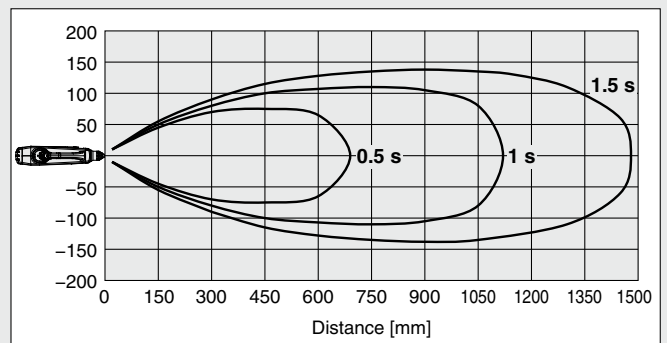

7) Supply pressure: 0.6 MPa Flow rate consumption: 450 L/min (ANR)

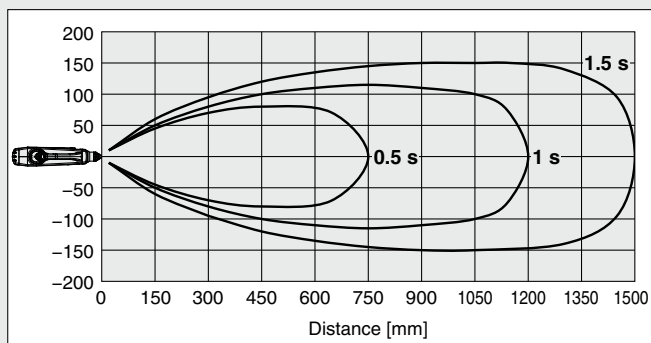

* Static neutralization characteristics are based on data using a charged plate (dimensions: 150 mm x 150 mm, capacitance: 20 pF) as defined in the U.S. ANSI standards (ANSI/ESD STM3.1-2015). Use this data only as a guideline for model selection because the values vary depending on the material and/or size of the subject.

Static Neutralization Characteristics

③ Pressure — Flow Rate Characteristics

Mode setting switch: Continuous blow

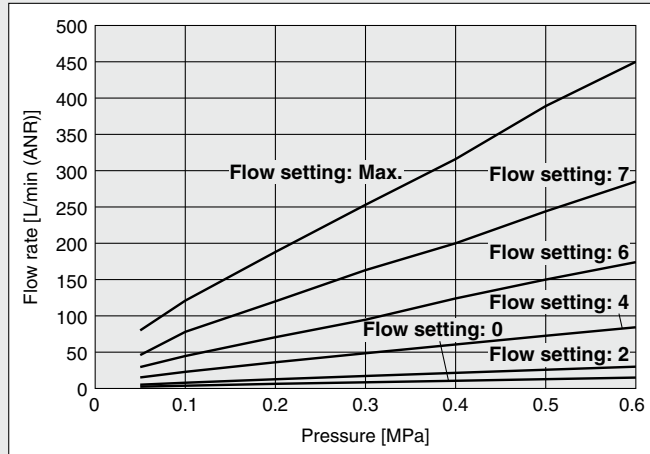

How to measure

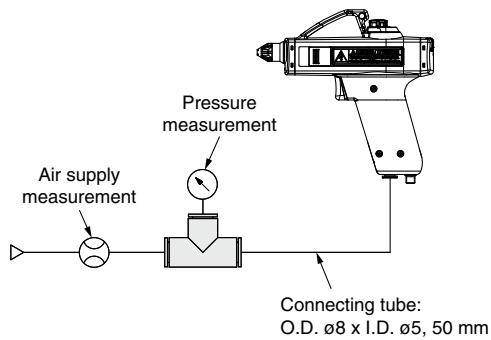

Gun Type Ionizer IZG10 Series



How to Order

IZG10-0801-01

One-touch fitting

Symbol	Applicable tubing O.D.
08	ø8 (Metric)
09	ø5/16" (Inch)

AC adapter, Power supply cable

Symbol	Type
01	AC adapter (With AC cord*1)
02	AC adapter (Without AC cord)
03	Power supply cable (For 24 VDC wiring)

*1 AC cord is only for use in Japan. (Rated voltage 125 V, Plug JIS C 8303, Inlet IEC 60320-C13)

⚠ Caution

The nozzle is specific for this product. Do not use any other nozzle. Doing so will adversely affect static neutralization performance.

Accessories (for Individual Parts)

AC adapter

IZG10-CG

AC adapter

1	With AC cord*1
2	Without AC cord

*1 AC cord is only for use in Japan. (Rated voltage 125 V, Plug JIS C 8303, Inlet IEC 60320-C13)

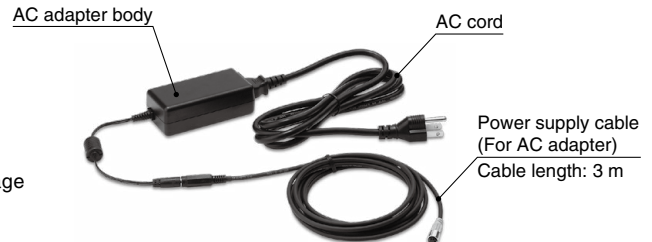

Power supply cable (For 24 VDC wiring)

IZG10-CP



Nozzle assembly

IZG10-A001-01



Emitter assembly

IZG10-NT



* A protective cap is attached to the tip of the emitter when shipped. Please remove the cap before use.

Cleaning kit

IZS30-M2

(With 1 felt pad, 1 rubber grindstone, and 2 replacement felt pads)

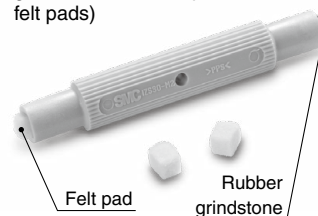

IZS30-A0201

(10 replacement felt pads)



IZS30-A0202

(1 replacement rubber grindstone)



Specifications

Ionizer model	IZG10	
Ion generation method	Corona discharge type	
Method of applying high voltage	High frequency AC type	
Applied voltage*1	±2.5 kV	
Offset voltage*2	Within ±10 V	
Air supply*3	Fluid	Air (Clean dry air)
	Operating pressure	0.05 to 0.6 MPa
	Connecting tube size	ø8 (Metric), ø5/16" (Inch)
Power supply voltage	24 VDC ±10% (21.6 to 26.4 V)	
Current consumption	90 mA (typ.)	
Ambient temperature	0 to 40°C (No freezing)	
Ambient humidity	35 to 65% Rh (No condensation)	
Material	Case: PBT Emitter: Tungsten	
Weight (Body only)	200 g	
Standards/Directive	CE	

- *1 Measured with a high pressure probe of 1000 MΩ and 5 pF
- *2 Measurement value based on a charged plate (dimensions: 150 mm x 150 mm, capacitance: 20 pF) as defined in the U.S. ANSI standards (ANSI/ESD STM3.1-2015)
The distance between the charged plate and the ionizer: 150 mm, the operating pressure is 0.2 MPa.
- *3 Static neutralization is not possible without supplying compressed air. Without compressed air, ozone or NOx generated by the ion generation process may accumulate and adversely affect the product and peripheral equipment.

AC Adapter Specifications

Input voltage*4	100 to 240 VAC 50/60 Hz
Output voltage	24 VDC ±5%
Output current	0.8 A max.
Ambient temperature	0 to 40°C
Ambient humidity	20 to 80% Rh
Standards/Directive	CE, cUL

- *4 The AC cord included with the AC adapter is only for use in Japan. (Rated voltage 125 V, Plug JIS C 8303, Inlet IEC 60320-C13)

Parts Description

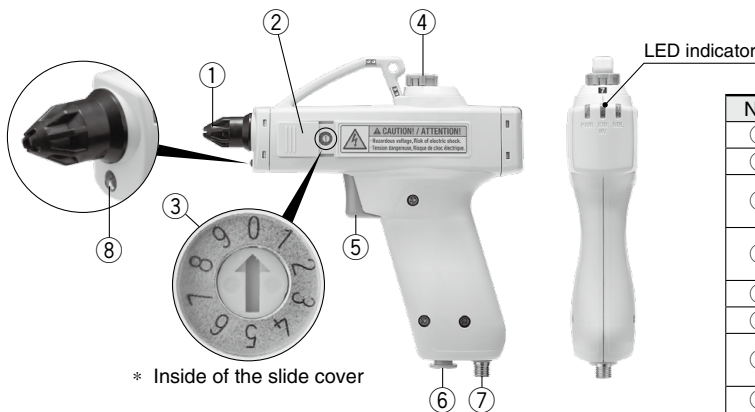

No.	Description	Contents
①	Nozzle	Discharge ionized air
②	Slide cover	Protective cover for the mode setting switch
③	Mode setting switch	Switch for setting blow and trigger (Default setting: Set no. 0)
④	Flow adjustment knob (With indicator)	Turn the knob to adjust the flow rate. Press the knob to lock the setting.
⑤	Trigger	Switch to turn on and off static neutralization
⑥	One-touch fitting	Supply port of compressed air
⑦	Power supply connector	Connector for power supply, F.G., and external switch inputs
⑧	Lighting LED	Illuminate the object during static neutralization

Description of LED Indicators

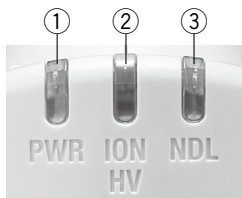

LED Indicators

No.	Display	LED color	Description	Contents
①	PWR	Green	Power supply indicator	Green LED turns ON when power is supplied, and the LED flashes when the voltage is outside of the specification range.
②	ION/HV	Green/Red	Static neutralization operation/incorrect high voltage indicator	Green LED turns ON during static neutralization. Red LED turns ON when a high voltage abnormality is present.
③	NDL	Green	Maintenance indicator	Green LED turns ON when lowered static neutralization performance due to the contamination or wear of the emitter is detected.

Alarm

The LEDs are used for notification of malfunctions.

Note that ion generation may either continue or stop depending on the type of abnormality.

Alarm name	Ion generation	LED			Description	Action to reset alarm
		PWR	ION/HV	NDL		
Power supply failure	Stop	Green (Flashing)	OFF	OFF	Connected power supply voltage is outside of specification.	Supply power again.
Incorrect high voltage	Stop	Green (ON)	Red (ON)	OFF	The high voltage output has dropped.	Supply power again.
CPU failure	Stop	Green (Flashing)	Red (Flashing)	Green (Flashing)	CPU error due to noise, etc.	Supply power again.
Maintenance indication	Continue	Green (ON)	—	Green (ON)	When static neutralization performance is reduced due to contamination, wear, or damage of the emitters	—

IZG10 Series

Mode Switch Setting

Blow or trigger setting can be selected by using the mode setting switch.

Open the slide cover and using a flat bladed screwdriver rotate the dial to select the setting number 0 to 9, referring to the table below.*1
Ensure the slide cover is closed when setting is complete.

*1 Default setting: Set no. 0

Table for Mode Setting Switch

Set no.	Blow setting	Trigger setting
0	Continuous blow	Trigger linked
1		Trigger lock
2		OFF timer 3 s
3		OFF timer 5 s
4		OFF timer 7 s
5	Pulse blow	Trigger linked
6		Trigger lock
7		OFF timer 3 s
8		OFF timer 5 s
9		OFF timer 7 s

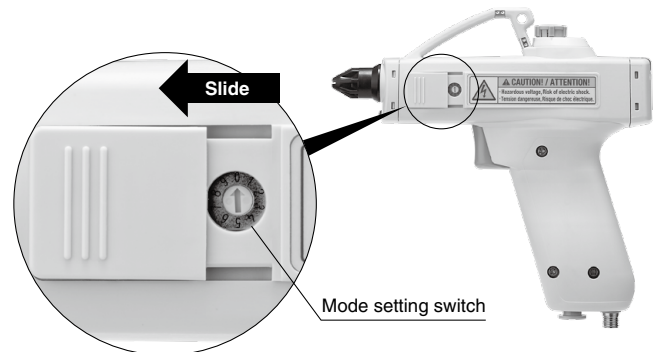

Wiring

AC adapter type IZG10-□01, 02

- Connect the M8 connector on the power cable for AC adapter to the power connector on the main unit. Connect the plug of the AC cord*1 to a commercial power outlet with a ground terminal (100 to 240 VAC, 50/60 Hz).
- Ensure the ground terminal is correctly connected. The ground terminal is connected to the frame ground (F.G.) of this product. Static neutralization performance is achieved by using the F.G. connection to maintain the same electrical potential as the reference potential of the operating environment.
- The input ground terminal and the output DC (-) terminal of the AC adapter (IZG10-CG1, 2 ordered separately) are electrically connected. Do not connect any equipment other than this product. Otherwise, a failure or electric shock may result.

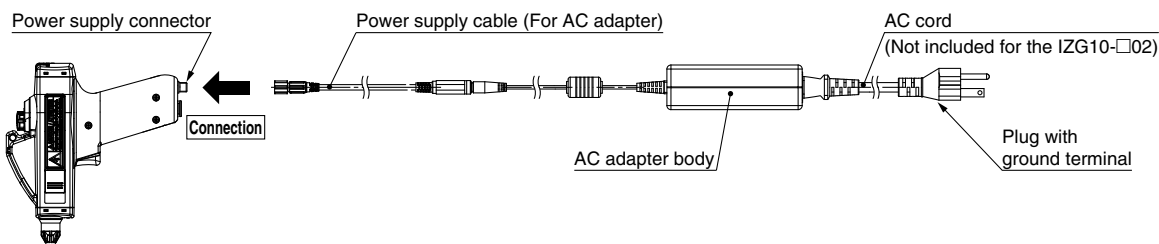

Ionizer body

AC adapter (With AC cord)

*1 The rated voltage of the AC cable supplied with IZG10-□01 is 125 V, and the plug is JIS C 8303 type B for Japanese domestic use. If the product is used in an area with a higher voltage rating (220 or 240 VAC), select IZG10-□02 without AC power cable, and use an AC cable with an IEC 60320-C13 ground terminal connector, suitable for the power supply voltage.

Power supply cable type IZG10-□03

- Connect the user equipment for the power supply and external switch input according to Power Supply Cable Wiring table.
- Ensure the green F.G. wire is correctly grounded. Static neutralization performance is achieved by maintaining the same electrical potential as the reference potential of the operating environment.

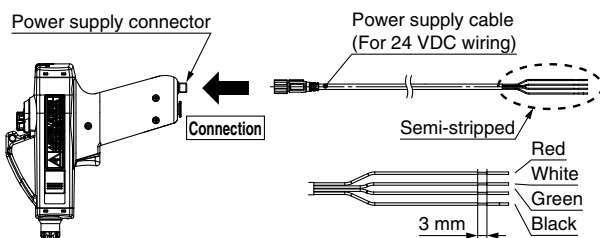

Ionizer body

Power supply cable (For 24 VDC wiring)

Internal circuits and wiring example

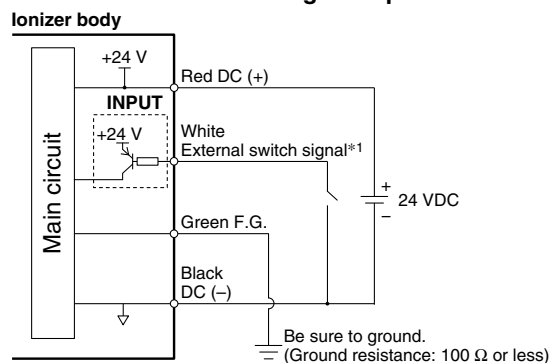

Power Supply Cable Wiring

Identification color	Signal name	Description
Red	DC (+)	Connect the power supply (+) terminal.
White	External switch signal*1	Blow starts by connecting to DC (-).
Green	F.G.	Frame ground of the product: Connect to Ground with resistance of 100 Ω or less.
Black	DC (-)	Connect to the power supply (-) terminal.

*1 The external switch signal is used in an OR configuration with the trigger input. When the external switch signal is not used, cut back the semi-strip wire to prevent any contact with the conductor.



Dimensions

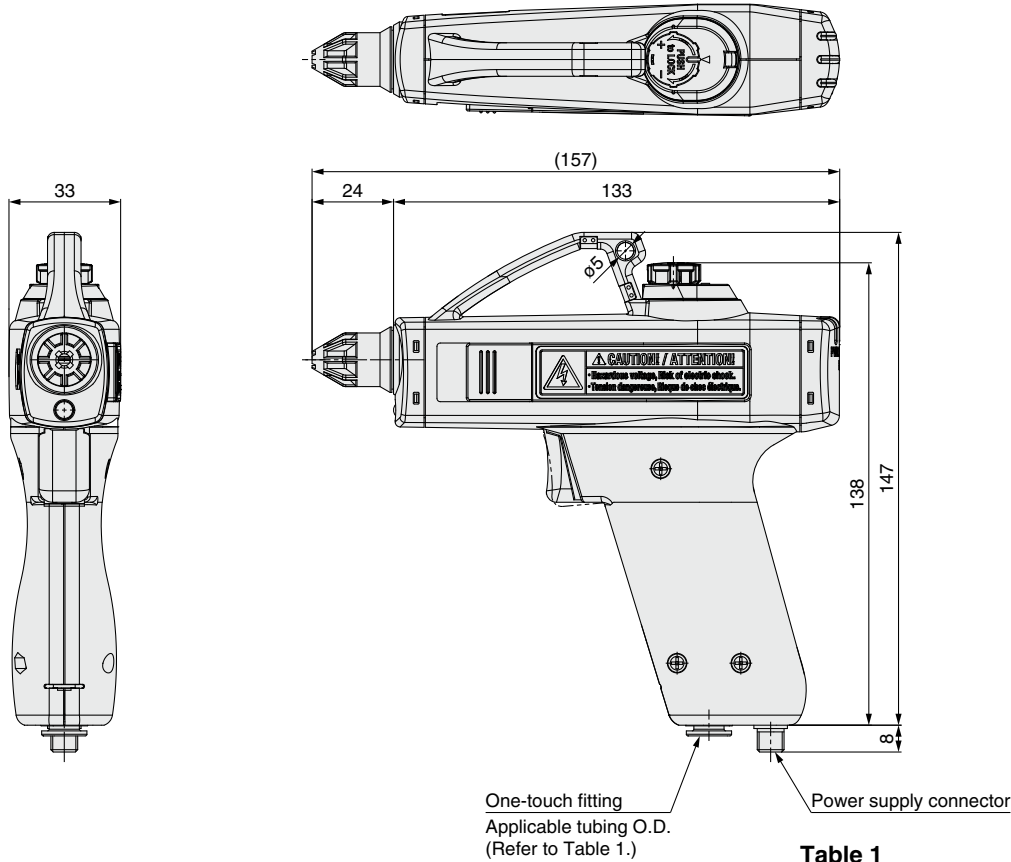
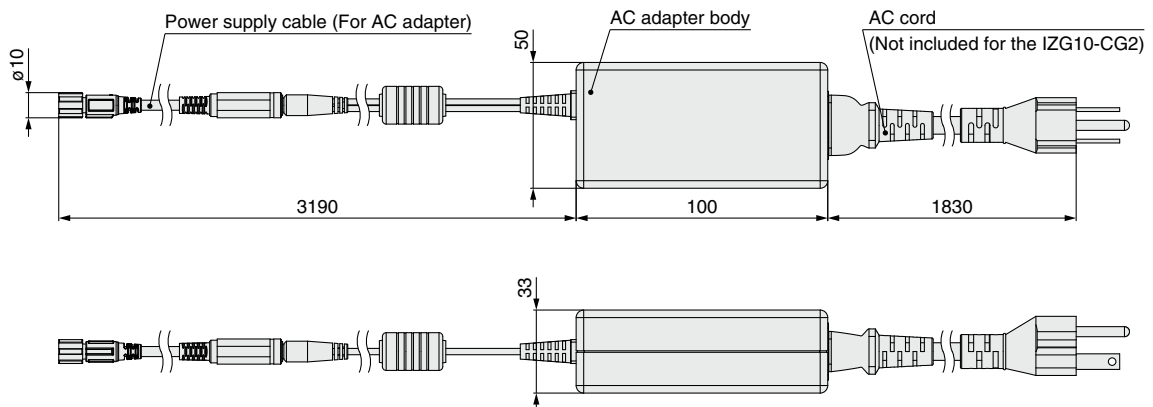

Table 1

Model	Applicable tubing O.D.
IZG10-08□-01	ø8 (Metric)
IZG10-09□-01	ø5/16" (Inch)

AC adapter IZG10-CG□



Model	AC cord
IZG10-CG1	Included
IZG10-CG2	None

Power supply cable (For 24 VDC wiring) IZG10-CP

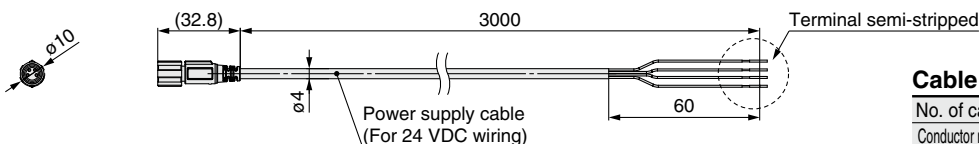

Cable Specifications

No. of cable wires/Size	4 cores/AWG26
Conductor nominal cross section	0.15 mm ²
Insulator O.D./identification color	0.85 mm/Red, Black, White, Green
Sheath material	Lead-free PVC
Outside diameter	4 mm

IZG10 Series Related Products

Recommended pneumatic circuit diagram

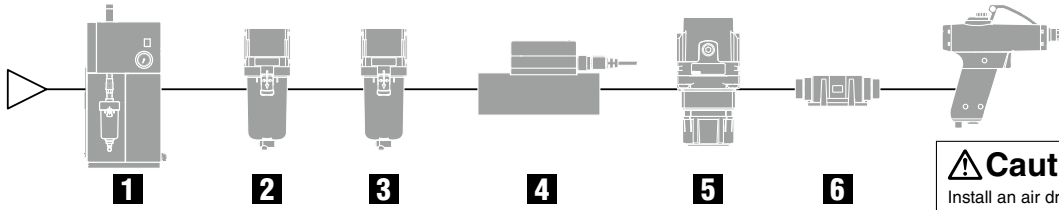

IZG10

Caution

Install an air dryer (IDF series), air filter (AF/AFF series), and/or mist separator (AFM/AM series) to obtain clean compressed air (compressed air quality of Class 2.4.3., 2.5.3., 2.6.3 or higher according to ISO 8573-1:2010 (JIS B 8392-1:2012) is recommended for operation).

1 Air Dryer IDF Series

Removes moisture in the compressed air



2 Air Filter AF/AFF Series

Eliminates solid foreign matter such as powder particles in the compressed air



3 Mist Separator AFM/AM Series

Eliminates oil mist which is difficult to eliminate with an air filter



4 3-Color Display Digital Flow Switch PF3A7□H Series

Flow range: Max. 12000 L/min
Flow ratio 100 : 1



5 2-Color Display Digital Flow Switch PFMB Series

Flow range: Max. 2000 L/min
Flow ratio 100 : 1



6 Regulator AR Series

Decreases the air consumption by setting to an appropriate pressure



6 Clean Air Filter SFD Series

For Clean Room

Built-in hollow fiber element Nominal filtration rating: 0.01 μm
Hollow fiber elements with over 99.99% filtering efficiency do not contaminate workpieces.



* Please contact SMC for clean room compatible ionizers.

Clean Air Module LLB Series

Modularized digital flow switch, regulator, ON/OFF valve, restrictor, and filter

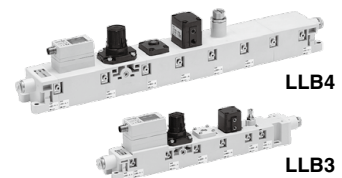

Related Products

Polyurethane Coil Tubing TCU Series

Flexible
Max. operating pressure: 0.8 MPa (at 20°C)
For moving applications
* Colors other than black are available as made-to-order specifications.

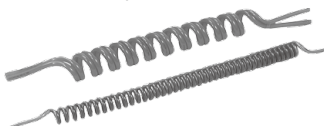

S Couplers KK/KKH Series

One-touch fitting type standardized (KK)
Uses ultra high-impact PBT resin (KKH)



Finger Valve VHK-A Series

The valve direction clearly indicates whether the valve is open or closed.
Small knob operating force (0.04 to 0.14 N·m)

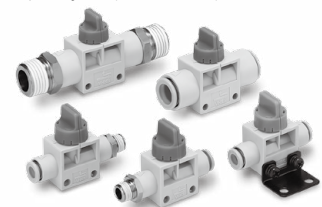



IZG10 Series

Specific Product Precautions 1

Be sure to read this before handling the products.
Refer to the back cover for safety instructions.

Selection

Warning

- 1. This product is intended to eliminate static electricity from the equipment for factory automation.**
If considering using the product for other applications (especially those indicated in warning (4) on the back cover), please consult with SMC beforehand.
- 2. Do not operate the product beyond the specifications.**
If the product is used outside of the specification range, it may cause malfunction, failure or damage to the product, leading to an electric shock, explosion or fire.
- 3. Do not operate the product outside of the specified ambient temperature and humidity range.**
Malfunction, failure, or damage to the product can result. Even within the specification range, freezing and condensation can cause malfunction, failure, or damage in environments where sudden temperature changes and temperature cycles are applied.
- 4. Use the product within the specified power supply voltage range.**
Using outside of the specified power supply voltage can cause a malfunction, damage, electrical shock, or fire.
- 5. Use clean compressed air as fluid. (Compressed air quality of Class 2.4.3., 2.5.3., 2.6.3 or higher according to ISO 8573-1:2010 (JIS B 8392-1:2012) is recommended for operation.)**
This product is not explosion proof. Never use a flammable gas or an explosive gas as a fluid and never use this product in the presence of such gases. Please contact us when fluids other than compressed air are used.
- 6. This product is not explosion-protected.**
Never use this product in locations where the explosion of dust is likely to occur or flammable or explosive gases are used. This can cause a fire.

Caution

- 1. Clean specification is not available with this product.**
When using in a clean room environment, confirm the required cleanliness before use.
A minute amount of particles are generated due to wearing of the emitters while the product is operating.

Wiring / Piping

Warning

- 1. Select the power supply capacity based on the product specifications.**
If the power supply capacity and voltage do not satisfy the product specifications, it will cause product failure or malfunction.
- 2. To maintain product performance, the power supply connected shall be UL listed Class 2 certified by National Electric Code (NEC) or evaluated as a limited power source provided by UL60950.**
- 3. Stop the electrical supply and remove the compressed air supply before any wiring (including insertion and removal of the connector) and piping is performed. Otherwise, an electrical shock or accident may occur.**

Wiring / Piping

Warning

- 4. To maintain the product performance, connect the product to power supply cable or AC adapter ground terminal with a resistance of 100 Ω or less. If the product is not grounded, it is not possible to maintain the performance and may lead to product failure or malfunction.**
- 5. If the ionizer wiring and high power lines are routed together, this product may malfunction due to noise. Therefore, use a separate wiring route for this product.**
- 6. Flush the piping before use. Before piping this product, exercise caution to prevent particles, water drops, or oil contents from entering the piping.**
- 7. If a valve is placed immediately before the product, regardless of the operational state of the trigger, instantaneous air release may occur when compressed air is supplied.**
- 8. Confirm that the wiring and piping are correct before supplying power and compressed air. Incorrect wiring and piping will lead to product damage or malfunction.**
- 9. Ensure the safety of wiring, piping, and surrounding conditions before supplying power and compressed air.**

Handling

Warning

- 1. Do not use the product without mounting the designated nozzle.**
- 2. Confirm that the nozzle is not loose and does not have play before supplying compressed air. If the nozzle is loose, tighten it by hand until it stops turning (guideline value for hand tightening torque: 0.1 to 0.2 N·m). Static neutralizing performance is reduced if the nozzle is loose.**
- 3. Be sure to wear protective eyewear when operating the product to protect your eyes from scattering debris.**
- 4. Do not direct the tip of the nozzle at the face or other parts of a human body. It may cause danger to personnel.**
- 5. Do not use the product to clean or remove toxic substances or chemicals.**
- 6. Do not drop, step on, or hit the product. It may cause damage to the product.**
- 7. Do not use the product to disturb public order or public hygiene.**
- 8. This product is not a toy.**
- 9. After blowing, make sure to hang the product on a hook, etc.**



IZG10 Series

Specific Product Precautions 2

Be sure to read this before handling the products.
Refer to the back cover for safety instructions.

Handling

⚠ Warning

10. Make sure that no twist, turn, tensile force or moment are applied to the One-touch fitting, tube and power cable during use or storage. Such actions may lead to product damage or broken wires.
11. Do not allow foreign matter or tools to enter the nozzle.

The inside of the nozzle contains emitters. If a metal tool makes contact with the emitters, it can cause electric shock, resulting in a sudden movement by the operator that can cause further injuries such as hitting the body on peripheral equipment. Also, if the tool damages the emitter, the ionizer may fail or cause an accident.

⚠ Danger High Voltage

Emitters are under high voltage. Never touch the emitters. Contact with or close proximity to the emitters may result in an electric shock. The reaction to such a shock could lead to further injuries due to collisions with surrounding equipment.



12. If a valve is placed immediately before the product, regardless of the operational state of the trigger, instantaneous air release may occur when compressed air is supplied.
13. If the supply pressure of compressed air is less than the product specification (0.05 MPa), the valve in the product may not operate correctly. Only use the product with a supply pressure within the product specification range.

Operating Environment / Storage Environment

⚠ Warning

1. Do not use this product in an enclosed space.
This product utilizes the corona discharge phenomenon. A small amount of ozone and NO_x will be generated. When the product is used in an enclosed space, the ozone concentration can increase, if so the smell of ozone may be uncomfortable or irritating. Even if the operating area is not an enclosed space, but multiple products are used in a small area, ozone concentration can still increase. The operating environment must always be ventilated.
2. Take preventative measures against ozone.
Pneumatic equipment used around this product should have ozone-prevention measures. Also, regularly check that there is no deterioration due to ozone.
3. Be sure to supply compressed air.
Static neutralization is not possible without supplying compressed air. Without compressed air, ozone or NO_x generated by the ion generation process may accumulate and adversely affect the product or peripheral equipment.
4. Use the product within the specified ambient temperature range.
The specified ambient temperature range is 0 to 40°C. Do not use the product in locations where the ambient temperature changes suddenly even within the specifications or if the temperature difference of the fluid relative to the ambient temperature is large condensation may occur.

Operating Environment / Storage Environment

⚠ Warning

5. Environments to avoid

Avoid using and storing this product in the following environments since they may cause damage to this product.

- a. Environments where the ambient temperature is outside of the product specification
- b. Environments where the ambient humidity is outside of the product specification
- c. Environments where abrupt temperature changes may cause condensation
- d. Environments where corrosive gas, flammable gas, or other volatile flammable substances are stored
- e. Environments where the product may be exposed to conductive powder such as iron powder or dust, oil mist, salt, organic solvent, spatter, machining chips, particles, cutting oil (including water and any liquids), etc.
- f. Environments where ventilated air from an air conditioner is directly applied to the product
- g. Enclosed or poorly ventilated environments
- h. Environments that are exposed to direct sunlight or heat radiation
- i. Environments where strong electromagnetic noise is generated, such as strong electrical and magnetic fields or supply voltage spikes
- j. Environments where static electricity is generated
- k. Environments where a strong high frequency occurs
- l. Environments that are subject to potential lightning strikes
- m. Environments where the product may receive direct impact or vibration
- n. Environments where the product may be subjected to forces or weight that could cause physical deformation

6. Do not use an air containing mist or dust.

The air containing mist or dust will cause the static neutralization performance to decrease and shorten the maintenance cycle. Install an air dryer (IDF series), air filter (AF/AFF series), and/or mist separator (AFM/AM series) to obtain clean compressed air (compressed air quality of Class 2.4.3., 2.5.3., 2.6.3 or higher according to ISO 8573-1:2010 (JIS B 8392-1:2012) is recommended for operation).

7. This product and AC adapter are not resistant to lightning surge.

8. Effects on implantable medical devices

The electromagnetic waves emitted from this product may interfere with implantable medical devices such as cardiac pacemakers and cardioverter defibrillators, resulting in the malfunction of the medical device or other adverse effects. Please use extreme caution when operating equipment which may have an adverse effect on your implantable medical device. Be sure to thoroughly read the precautions stated in the catalog, operation manual, etc., of your implantable medical device, or contact the manufacturer directly for further details on what types of equipment need to be avoided.



IZG10 Series

Specific Product Precautions 3

Be sure to read this before handling the products.
Refer to the back cover for safety instructions.

Maintenance

Warning

1. Periodically inspect the ionizer and clean the emitters.

- Check regularly if the product is operating with undetected failures or not.
- The maintenance must be performed by an operator who has sufficient knowledge and experience.
- If the product is used for an extended period with dust present on the emitters, the static neutralization performance will be reduced. It is recommended to clean the emitters periodically. (Emitter contamination level is different depending on the operating environment and supply pressure.)
- When the maintenance LED turns ON, clean the emitters and confirm the static neutralization performance.
- If the static neutralization performance is not recovered after cleaning, it is possible that emitters are worn. Replace the emitter assembly.

Danger High Voltage

This product contains a high voltage generation circuit. When performing maintenance inspection, be sure to confirm that the power supply to the ionizer is turned off. Never disassemble or modify the ionizer, as this may not only impair the product's functionality but could cause an electric shock or electric leakage.

2. When cleaning or replacing the emitter, be sure to turn off the power supply or compressed air supply to the body.

Maintenance of the product with power or compressed air supplies connected can cause an electric shock or accident.

3. Securely mount the emitters.

If emitters are not securely mounted, they may eject or release when compressed air is supplied to the product.

4. Do not touch the emitters directly.

They have a sharp end and touching them may cause injury.

5. Do not disassemble or modify the product.

Otherwise, an electrical shock, damage and/or a fire may occur. Also, the disassembled or modified products may not achieve the performances guaranteed in the specifications, and exercise caution because the product will not be warranted.

6. Do not operate the product with wet hands.

Otherwise, an electric shock or accident may occur.

Caution

1. Periodically check the following items and replace the parts if necessary.

- a. Contamination and wear of emitters
- b. Loosening and damage of nozzles
- c. Twists or crushing of connected tubes
- d. Hardness and deterioration of connected tubes
- e. Air leakage

Safety Instructions

These safety instructions are intended to prevent hazardous situations and/or equipment damage. These instructions indicate the level of potential hazard with the labels of “**Caution**,” “**Warning**” or “**Danger**.” They are all important notes for safety and must be followed in addition to International Standards (ISO/IEC)*1), and other safety regulations.

 **Caution:** **Caution** indicates a hazard with a low level of risk which, if not avoided, could result in minor or moderate injury.

 **Warning:** **Warning** indicates a hazard with a medium level of risk which, if not avoided, could result in death or serious injury.

 **Danger :** **Danger** indicates a hazard with a high level of risk which, if not avoided, will result in death or serious injury.

*1) ISO 4414: Pneumatic fluid power – General rules relating to systems.
ISO 4413: Hydraulic fluid power – General rules relating to systems.
IEC 60204-1: Safety of machinery – Electrical equipment of machines.
(Part 1: General requirements)
ISO 10218-1: Manipulating industrial robots – Safety.
etc.

Warning

1. The compatibility of the product is the responsibility of the person who designs the equipment or decides its specifications.

Since the product specified here is used under various operating conditions, its compatibility with specific equipment must be decided by the person who designs the equipment or decides its specifications based on necessary analysis and test results. The expected performance and safety assurance of the equipment will be the responsibility of the person who has determined its compatibility with the product. This person should also continuously review all specifications of the product referring to its latest catalog information, with a view to giving due consideration to any possibility of equipment failure when configuring the equipment.

2. Only personnel with appropriate training should operate machinery and equipment.

The product specified here may become unsafe if handled incorrectly. The assembly, operation and maintenance of machines or equipment including our products must be performed by an operator who is appropriately trained and experienced.

3. Do not service or attempt to remove product and machinery/equipment until safety is confirmed.

1. The inspection and maintenance of machinery/equipment should only be performed after measures to prevent falling or runaway of the driven objects have been confirmed.
2. When the product is to be removed, confirm that the safety measures as mentioned above are implemented and the power from any appropriate source is cut, and read and understand the specific product precautions of all relevant products carefully.
3. Before machinery/equipment is restarted, take measures to prevent unexpected operation and malfunction.

4. Contact SMC beforehand and take special consideration of safety measures if the product is to be used in any of the following conditions.

1. Conditions and environments outside of the given specifications, or use outdoors or in a place exposed to direct sunlight.
2. Installation on equipment in conjunction with atomic energy, railways, air navigation, space, shipping, vehicles, military, medical treatment, combustion and recreation, or equipment in contact with food and beverages, emergency stop circuits, clutch and brake circuits in press applications, safety equipment or other applications unsuitable for the standard specifications described in the product catalog.
3. An application which could have negative effects on people, property, or animals requiring special safety analysis.
4. Use in an interlock circuit, which requires the provision of double interlock for possible failure by using a mechanical protective function, and periodical checks to confirm proper operation.

Caution

1. The product is provided for use in manufacturing industries.

The product herein described is basically provided for peaceful use in manufacturing industries.
If considering using the product in other industries, consult SMC beforehand and exchange specifications or a contract if necessary.
If anything is unclear, contact your nearest sales branch.

Limited warranty and Disclaimer/ Compliance Requirements

The product used is subject to the following “Limited warranty and Disclaimer” and “Compliance Requirements”.

Read and accept them before using the product.

Limited warranty and Disclaimer

1. The warranty period of the product is 1 year in service or 1.5 years after the product is delivered, whichever is first.*2)
Also, the product may have specified durability, running distance or replacement parts. Please consult your nearest sales branch.
2. For any failure or damage reported within the warranty period which is clearly our responsibility, a replacement product or necessary parts will be provided.
This limited warranty applies only to our product independently, and not to any other damage incurred due to the failure of the product.
3. Prior to using SMC products, please read and understand the warranty terms and disclaimers noted in the specified catalog for the particular products.

*2) Vacuum pads are excluded from this 1 year warranty.

A vacuum pad is a consumable part, so it is warranted for a year after it is delivered.
Also, even within the warranty period, the wear of a product due to the use of the vacuum pad or failure due to the deterioration of rubber material are not covered by the limited warranty.

Compliance Requirements

1. The use of SMC products with production equipment for the manufacture of weapons of mass destruction (WMD) or any other weapon is strictly prohibited.
2. The exports of SMC products or technology from one country to another are governed by the relevant security laws and regulations of the countries involved in the transaction. Prior to the shipment of a SMC product to another country, assure that all local rules governing that export are known and followed.

Caution

SMC products are not intended for use as instruments for legal metrology.

Measurement instruments that SMC manufactures or sells have not been qualified by type approval tests relevant to the metrology (measurement) laws of each country. Therefore, SMC products cannot be used for business or certification ordained by the metrology (measurement) laws of each country.

 **Safety Instructions** Be sure to read the “Handling Precautions for SMC Products” (M-E03-3) and “Operation Manual” before use.

SMC Corporation

Akihabara UDX 15F,
4-14-1, Sotokanda, Chiyoda-ku, Tokyo 101-0021, JAPAN
Phone: 03-5207-8249 Fax: 03-5298-5362
<https://www.smcworld.com>
© 2020 SMC Corporation All Rights Reserved

Specifications are subject to change without prior notice and any obligation on the part of the manufacturer.

D-G

1st printing YW printing YW 7830KS Printed in Japan.