

3-Color Display Digital Flow Switch for Large Flow

Applicable fluid **Air, N₂**



IP65



Flow ratio ^{*2} **100:1** A wide range of flow measurement is possible with 1 product.

*2 The flow ratio is 20 : 1 for the existing model (PF2A7□□H/Large flow type).

Series	Output type	Rated flow range [L/min]
Body ported type PF3A703/706/712H(-L) Series	Switch output	30 3000 L type 3000
	Analog output	60 6000 L type 6000
	IO-Link	120 12000 L type 12000
Modular type PF3A701/702H(-L) Series	Switch output	10 1000 L type 1000
	Analog output	20 2000 L type 2000
	IO-Link	
New Modular type With pressure/ temperature sensor PF3A801/802H-L Series	Switch output	10 1000 L type 1000
	IO-Link	20 2000 L type 2000

New

IO-Link

4-Screen Display

**Digital Flow Switch with Pressure/
Temperature Sensor**

Simultaneous measurement of the (accumulated) flow rate, pressure, and temperature is possible.

PF3A8□H-L Series **p. 6**

Modular type

Can be connected to the air combination **p. 5**



3-Screen Display Digital Flow Monitor



Allows for the monitoring of remote lines **p. 7**

IO-Link Compatible

The measured value and the device status can be figured out easily via the process data. **p. 3**

Improved resistance to moisture and foreign matter

The bypass construction reduces sensor accuracy deterioration and damage. **p. 1**

PF3A□H(-L) Series



Improved resistance to moisture and foreign matter

The bypass construction reduces the moist air or foreign matter in contact with the sensor, reducing sensor accuracy deterioration and damage.

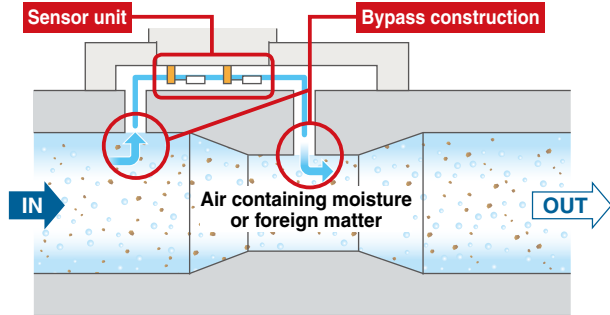

* The figure shows the PF3A703/6/12H(-L).

Through bore construction

- Pressure loss: **75% reduction** ^{*2}
(20 kPa → 5 kPa)
- Maintenance-free fluid passage



*1 Excludes the modular type
*2 Compared with the existing model (PF2A7□H/ Large flow type)

3-color/2-screen display

* 2-screen display: 2-row display of main screen and sub screen

Upper Main display: **Green** At set point

Upper Main display: **Red** At set point

Instantaneous flow rate **Green** **Red** (Upper Main display)



Set value **Orange** (Lower Sub display)

The lower/sub display can be changed by pressing the up/down buttons.

* Either "Input of line name" or "Display OFF" can be added via the function settings.



Display rotates 90° and can be reversed.

Clockwise **90°** Easy operation, improved visibility

The display can be rotated in increments of 90° according to the installation. The display can be reversed for easy operation.



Installation Example

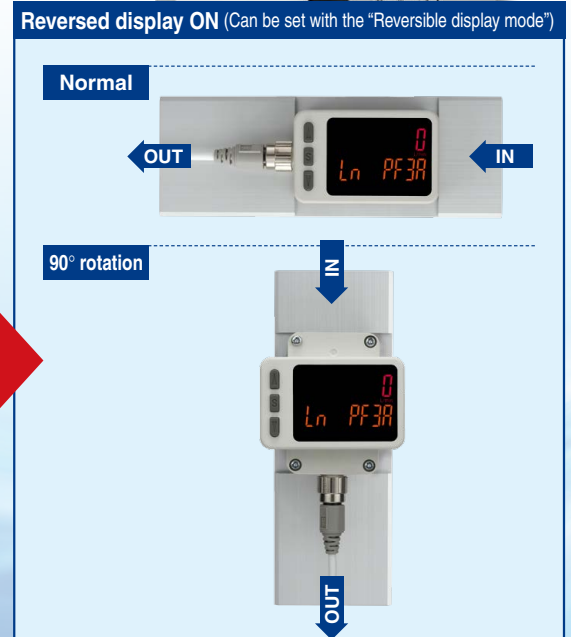
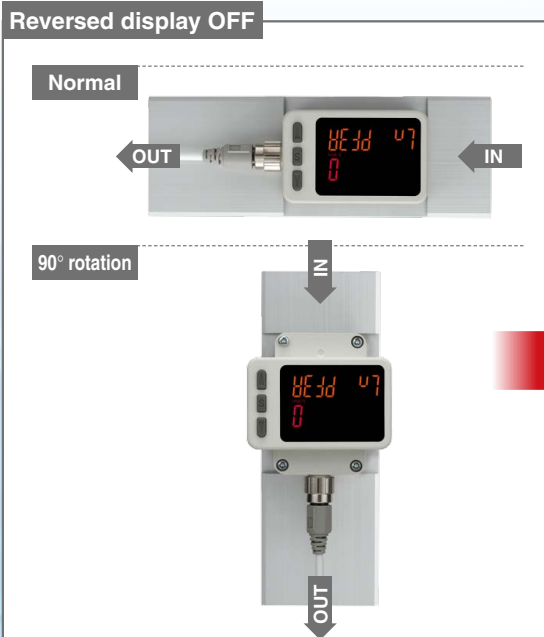

Smallest settable increment: 2 L/min

- * For the PF3A703H
- * 5 L/min for the existing model (PF2A703H/Large flow type)

Functions pp. 37 to 39

- Output operation
- Simple setting mode
- Display color
- Reference condition
- Response time (Digital filter)
- FUNC output switching function (Analog output ⇔ External input)
- Selectable analog output function
- External input function
- Forced output function
- Accumulated value hold
- Peak/Bottom value display
- Display OFF mode
- Setting of a security code
- Key-lock function
- Reset to the default settings
- Reversible display mode
- Zero cut-off function
- Delay time setting
- Selection of the display on the sub screen
- Analog output free range function
- Error display function
- Zero-clear function
- Display fine adjustment function
- Measurement display setting

Grease-free

Application

Flow control of equipment, main line, and branch line

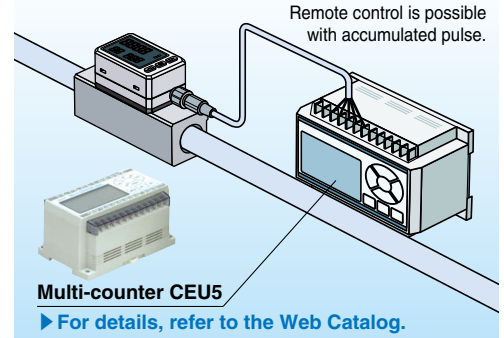

Select a digital flow switch to increase energy savings!

Flow control is necessary for promoting energy saving in any application. Saving energy starts from numerical control of the flow consumption of equipment and lines and clarification of the purpose and effect.

- Digital display allows visualization.
- 3-color/2-screen display, Improved visibility
- Remote control is possible with accumulated pulse.

Energy Saving Program

For details, refer to the SMC website.

<https://www.smcworld.com> SMC Model Selection Software Search

Energy Saving Program

Allows you to perform various calculations necessary to improve the pneumatic energy saving.

This software is the download version. After downloading the software, install it into your personal computer.

Download the program

Ver.4.1.02 2017/01/23 Update

How to Install

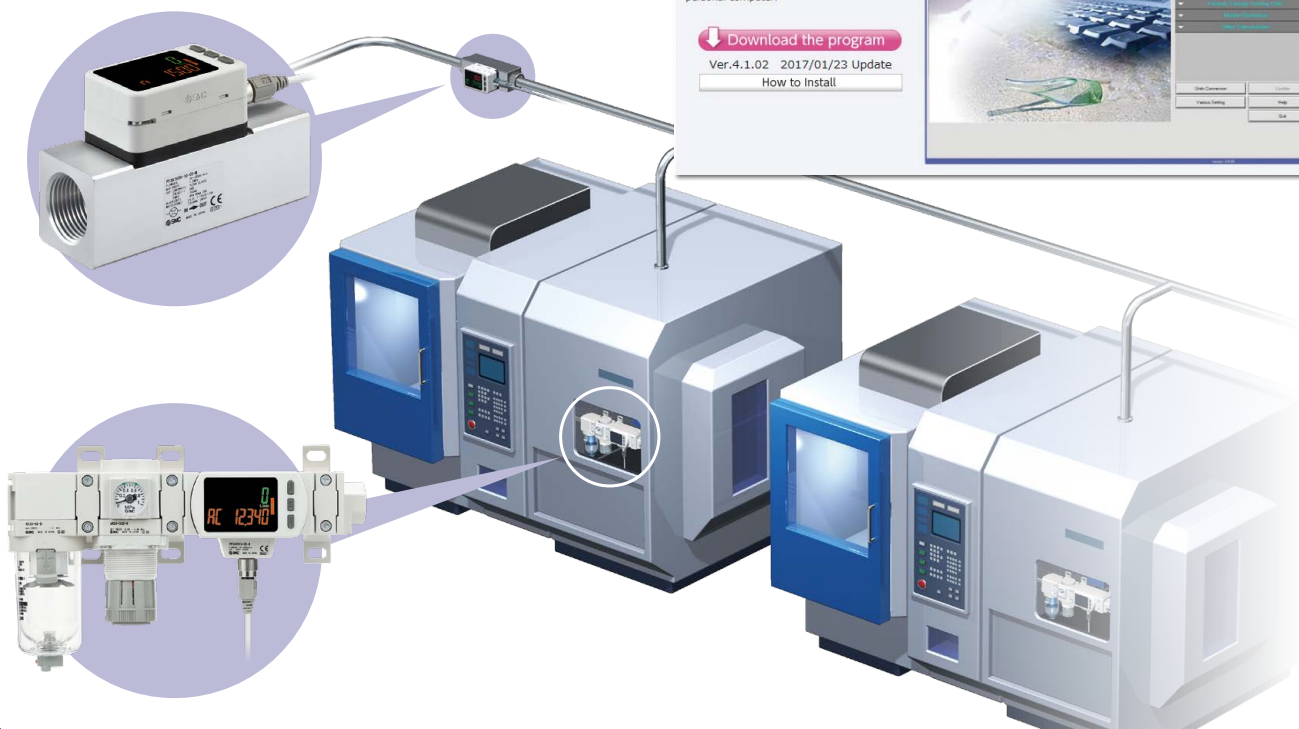

IO-Link Compatible PF3A□□H-□□-L□-□□ p.15

Supports the IO-Link communication protocol



IO-Link is an open communication interface technology between the sensor/actuator and the I/O terminal that is an international standard: IEC 61131-9.

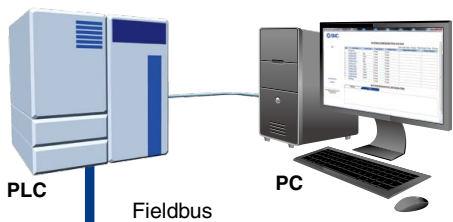

Configuration File (IODD File*1)

· Manufacturer · Product part no. · Set value

*1 IODD File:
IODD is an abbreviation of IO Device Description. This file is necessary for setting the device and connecting it to a master. Save the IODD file on the PC to be used to set the device prior to use.

Device settings can be set by the master.

- Threshold value
- Operation mode, etc.

Read the device data.

- Switch ON/OFF signal and analog value
- Device information: Manufacturer, Product part number, Serial number, etc.
- Normal or abnormal device status
- Cable breakage

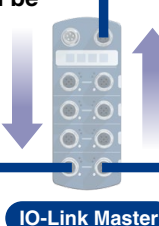

IO-Link Compatible Device: Digital Flow Switch for Large Air Flow PF3A7□H-L Series



IO-Link Compatible Device: Digital Flow Switch for Large Air Flow PF3A8□H-L Series

Display function

Displays the output communication status and indicates the presence of communication data

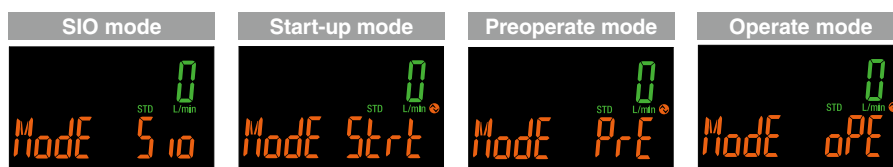

Operation and Display

Communication with master	IO-Link status indicator light	Status	Screen display*2	Description	
Yes	*1	Normal	Operate	Mode oPE	Normal communication status (readout of measured value) At the start of communication
			Start up	Mode Strt	
			Preoperate	Mode PrE	
No	*1 (Flashing)	Abnormal	Version does not match	Er 15 1 10	The IO-Link version does not match that of the master. * The applicable IO-Link version is 1.1.
			Communication disconnection	Mode oPE Mode Strt Mode PrE	
		OFF	SIO mode	Mode Sio	General switch output

*1 In IO-Link mode, the IO-Link indicator is ON or flashing. *2 When the lower line (sub screen) is set to mode display (Upper line for the PF3A8□H-L)
* "ModE LoC" is displayed when the data storage lock is enabled. (Except for when the version does not match or when in SIO mode)

Implement diagnostic bits in the process data.

The diagnostic bit in the cyclic process data makes it easy to find problems with the equipment. It is possible to find problems with the equipment in real time using the cyclic (periodic) data and to monitor such problems in detail with the noncyclic (aperiodic) data.

For the PF3A7□H-L

Process Data

Bit offset	Item	Note	Diagnosis items
0	OUT1 output	0: OFF 1: ON	<ul style="list-style-type: none"> · Over current error · Rated flow error · Accumulated flow error · Flow sensor failure · Temperature sensor failure · Internal product malfunction
1	OUT2 output	0: OFF 1: ON	
8	Flow rate diagnosis	0: OFF 1: ON	
14	Fixed output	0: OFF 1: ON	
15	Error (Failure)	0: OFF 1: ON	
16 to 31	Measured flow rate value	Signed 16 bit	



Bit offset	31	30	29	28	27	26	25	24	23	22	21	20	19	18	17	16
Item	Measured flow rate value (PD)															

Bit offset	15	14	13	12	11	10	9	8	7	6	5	4	3	2	1	0	
Item	Error (Failure)	Fixed output	Reservation					Flow rate diagnosis	Reservation							OUT2	OUT1
																Switch output	

For the PF3A8□H-L

Process Data

Bit offset	Item	Note	Bit offset	Item	Note
0	Accumulated flow SW1	0: OFF 1: ON	11	Temperature diagnosis	0: Normal 1: HHH/LLL
1	Accumulated flow SW2	0: OFF 1: ON	12	Pressure diagnosis	0: Normal 1: HHH/LLL
2	Flow rate SW1	0: OFF 1: ON	13	Fixed output	0: Normal output 1: Fixed output
3	Flow rate SW2	0: OFF 1: ON	14	Error	0: Normal 1: Abnormal
4	Temperature SW1	0: OFF 1: ON	15	System error	0: Normal 1: Abnormal
5	Temperature SW2	0: OFF 1: ON	16 to 31	Measured pressure value	Signed 16 bit
6	Pressure SW1	0: OFF 1: ON	32 to 47	Measured temperature value	Signed 16 bit
7	Pressure SW2	0: OFF 1: ON	48 to 63	Measured flow rate value	Signed 16 bit
8	Flow rate unit	0: L 1: ft3	64 to 79	Accumulated flow rate lower limit	Unsigned 32 bit
9	Flow rate criteria	0: STD 1: nor	80 to 95	Accumulated flow rate upper limit	
10	Flow rate diagnosis	0: Normal 1: HHH			

Diagnosis items
<ul style="list-style-type: none"> · Rated flow error · Above/Below the rated pressure range · Above/Below the rated temperature range · Error (Over current, Outside of zero-clear range, Version does not match) · System error (Flow/Temperature sensor failure, Internal malfunction)



Bit offset	95	94	93	92	91	90	89	88	87	86	85	84	83	82	81	80
Item	Accumulated flow rate upper limit (PD)															
Bit offset	79	78	77	76	75	74	73	72	71	70	69	68	67	66	65	64
Item	Accumulated flow rate lower limit (PD)															
Bit offset	63	62	61	60	59	58	57	56	55	54	53	52	51	50	49	48
Item	Measured flow rate value (PD)															
Bit offset	47	46	45	44	43	42	41	40	39	38	37	36	35	34	33	32
Item	Measured temperature value (PD)															
Bit offset	31	30	29	28	27	26	25	24	23	22	21	20	19	18	17	16
Item	Measured pressure value (PD)															
Bit offset	15	14	13	12	11	10	9	8	7	6	5	4	3	2	1	0
Item	System error	Error	Fixed output	Pressure diagnosis	Temperature diagnosis	Flow rate diagnosis	Flow rate criteria	Flow rate unit	Pressure 2	Pressure 1	Temperature 2	Temperature 1	Flow rate 2	Flow rate 1	Accumulated flow 2	Accumulated flow 1

Application Example

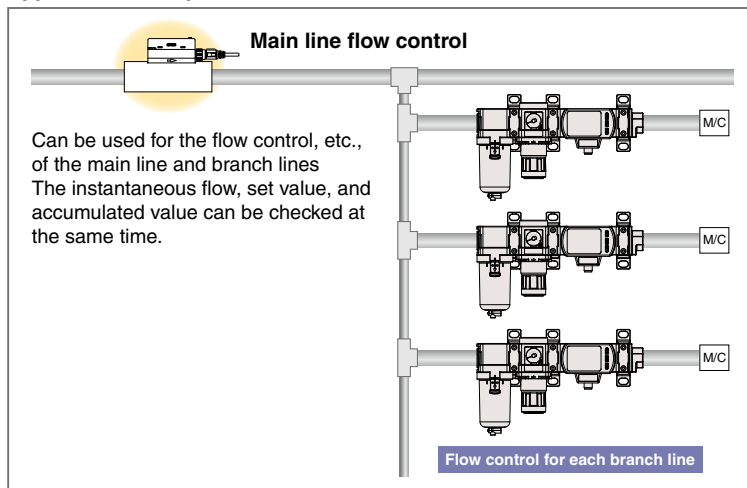

3-Color Display Modular Type Digital Flow Switch PF3A701H/702H(-L) Series

pp. 17, 19

Can be connected to the air combination

Series	AC30-D	AC40-D	Flow range
PF3A701H(-L)	●		1000 L/min
PF3A702H(-L)		●	2000 L/min



Air Combination Connection Examples

Products do not come assembled. They should be ordered separately and assembled by the customer.

For the AC30B-D + PF3A701H

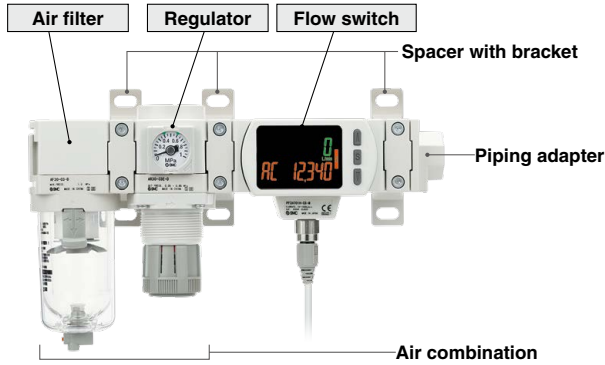

For the AW30-D + PF3A701H

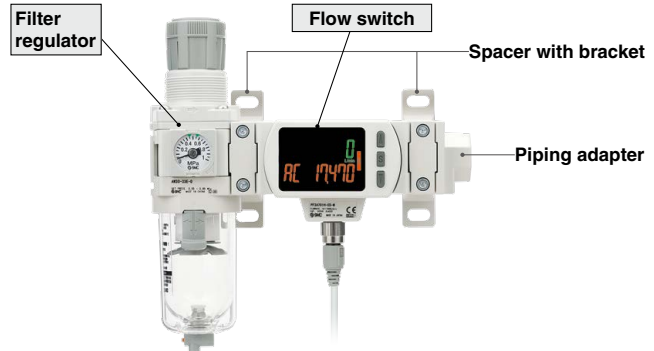

Simple Specials System

Unit with F.R.L is available with the simple special ordering system. The lead time is almost the same as the standard product.

Please contact your local sales representative for more details.

A right to left (-R) flow direction is also available.



90° rotation



The flow switch can be installed/removed without removing the piping.

Reduced maintenance time for inspection, cleaning, replacement, etc.

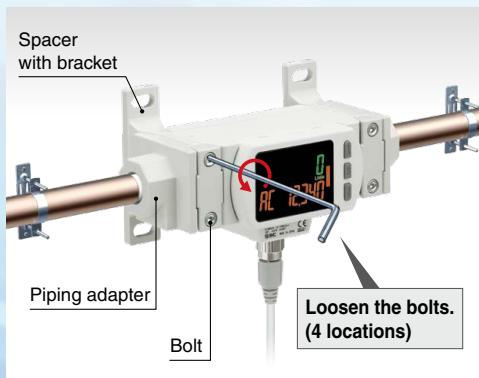

When the PF3A703H is used with steel pipes

Loosen the bracket-retaining ring.

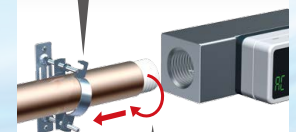

Remove the steel pipe from the flow switch.

4-Screen Display Modular Type Digital Flow Switch with Pressure/Temperature Sensor

PF3A801H/802H-L Series p. 21

Can be connected to the air combination

Series	AC30-D	AC40-D	Flow range	Pressure	Temperature
PF3A801H-L	●		1000 L/min	1 MPa	50°C
PF3A802H-L		●	2000 L/min		



3-color/4-screen display

Simultaneous measurement of the instantaneous flow rate, accumulated flow rate, pressure, and temperature

Pressure sensor

Rated pressure range: 0 to 1 MPa

Temperature sensor

Rated temperature range: 0 to 50°C

Space-saving design, Reduced labor

Both the flow rate and pressure can be measured with 1 product.

The installation of a digital pressure switch and a cross spacer is not necessary, thus reducing the face-to-face and depth dimensions. In addition, only 1 cable is required for wiring. This reduces the required installation space, piping, and wiring work.

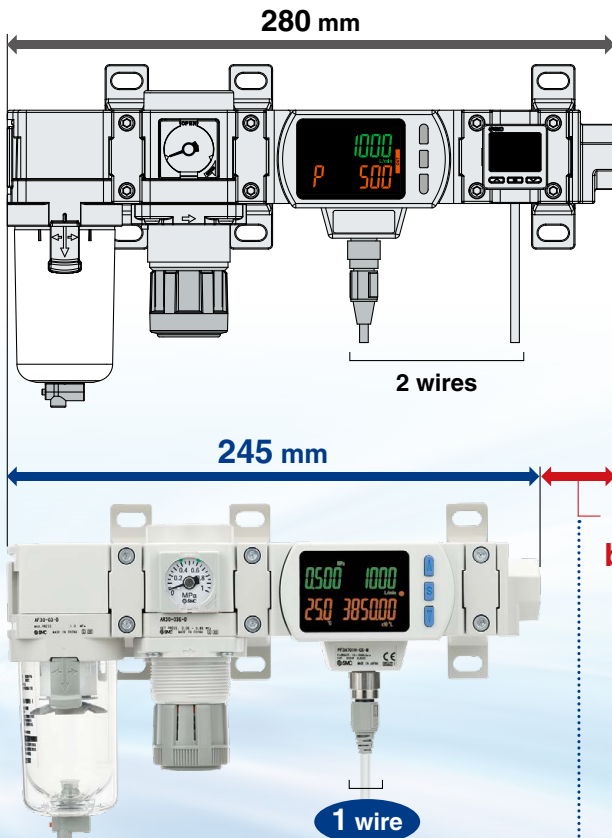
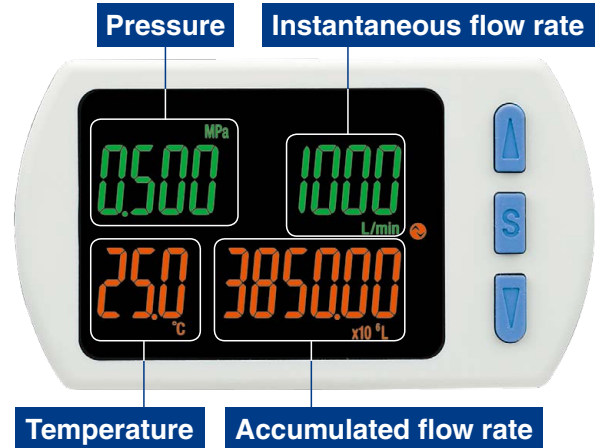

**Reduced wiring labor
(2 wires → 1 wire)**

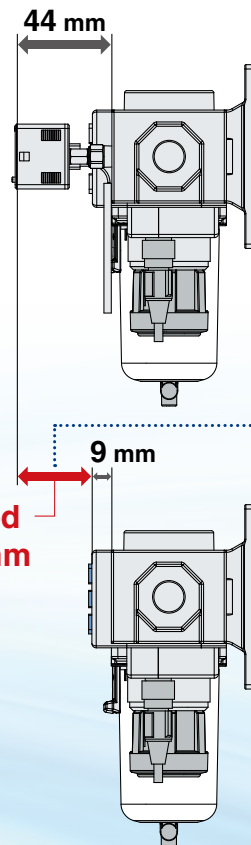

**Depth dimension
reduced by 35 mm**

**Face-to-face dimension
reduced by 35 mm**

3-Screen Display Digital Flow Monitor

PFG300 Series p. 31



Allows for the monitoring of remote lines

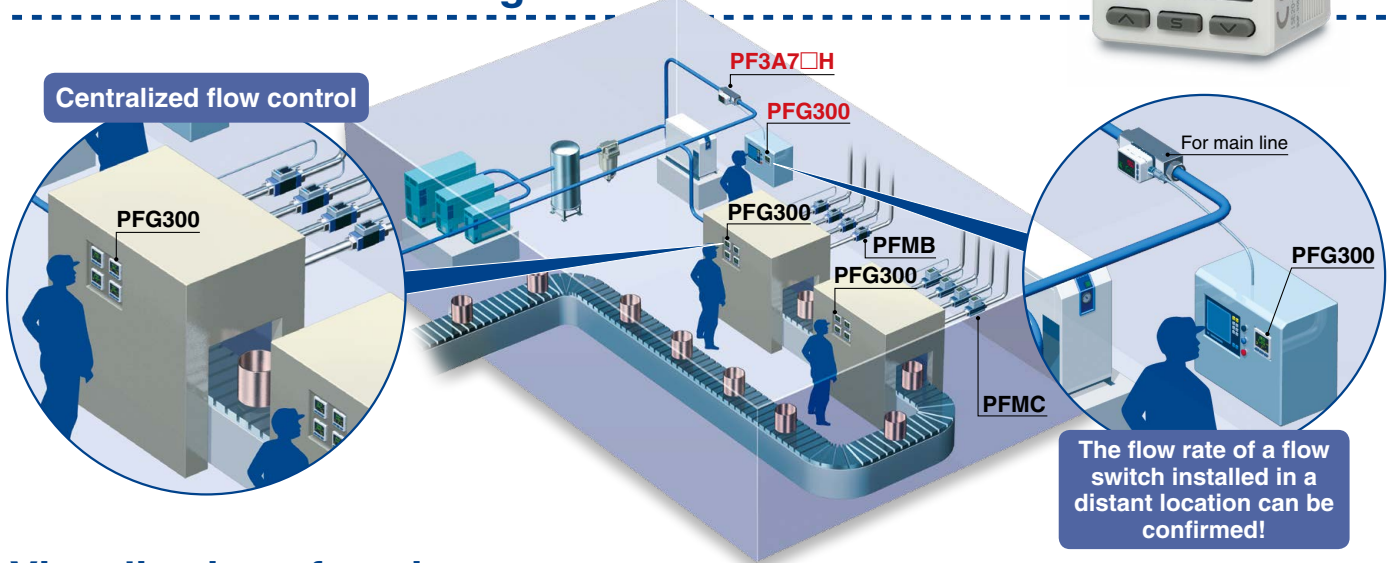

Visualization of settings

The sub screen (label) shows the item to be set.

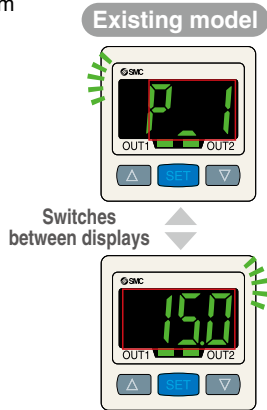

Mode Examples

Hysteresis mode					
Normal output	Set value (Threshold value)	Reversed output	Set value (Threshold value)	Hysteresis	Set hysteresis value
P.1	1500	n.1	1500	H.1	150

Window comparator mode					
Normal output/Lo side	Set value (Threshold value)	Normal output/Hi side	Set value (Threshold value)	Reversed output/Lo side	Set value (Threshold value)
P.L	900	P.H	1800	n.L	900
				n.H	1800

Easy screen switching

It is possible to change the settings while checking the measured value.

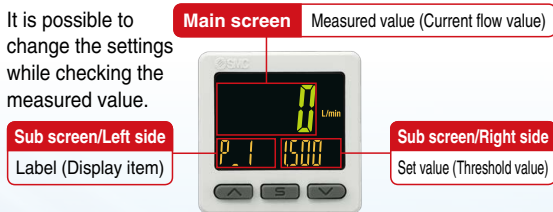

The sub screen can be switched by pressing the up/down buttons.

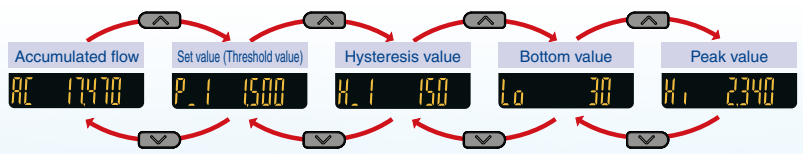

* Either "Input of line name" or "Display OFF" can be added via the function settings.

Simple 3-step setting

When the S button is pressed and the set value (P_1) is being displayed, the set value (threshold value) can be set. When the S button is pressed and the hysteresis (H_1) is being displayed, the hysteresis value can be set.

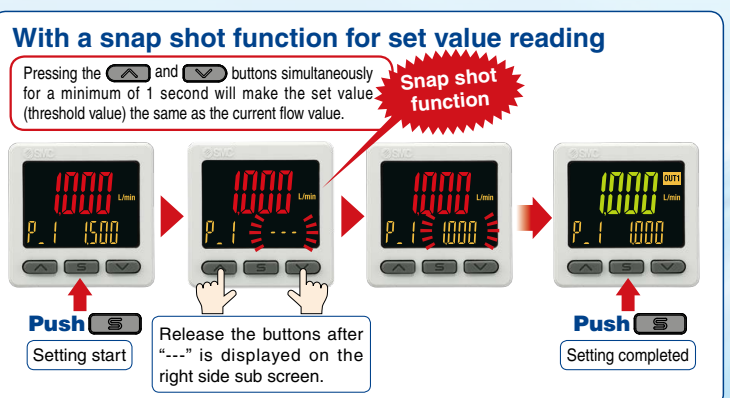
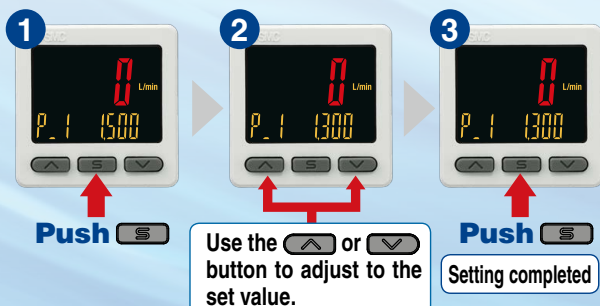

NPN/PNP switch function

The number of stock items can be reduced.

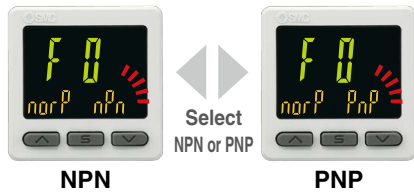

Input range selection (for Pressure/Flow rate)

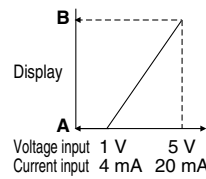

The displayed value to the sensor input can be set as required. (Voltage input: 1 to 5 V/Current input: 4 to 20 mA)
Pressure switch/Flow switch can be displayed.

A is displayed for 1 V (or 4 mA). B is displayed for 5 V (or 20 mA). The range can be set as required.

Analog output of 0 to 10 V is also available.

Voltage output	1 to 5 V	Switchable
	0 to 10 V	
Current output	4 to 20 mA	Fixed

■ Pressure Sensor for General Fluids/PSE570

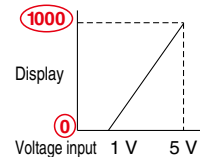

	A	B
PSE570	0	1000
PSE573	-100	100
PSE574	0	500

Set A and B to the values shown in the table above.

Convenient functions

● Copy function

The settings of the master monitor can be copied to the slave monitors.

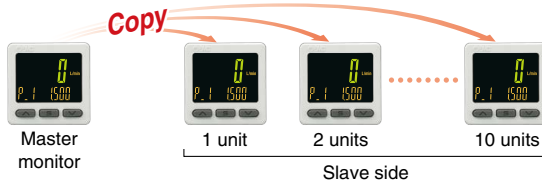

● Security code

The key locking function keeps unauthorized persons from tampering with the settings.

● Power saving mode

Power consumption is reduced by turning off the monitor.

Current consumption*1	Reduction rate*2
25 mA or less	Approx. 50% reduction

*1 During normal operation *2 In power saving mode

● External input function

The accumulated value, peak value, and bottom value can be reset remotely.

Compact & Lightweight

● Compact: Max. 6 mm shorter

● Lightweight: Max. 5 g lighter (30 g → 25 g)

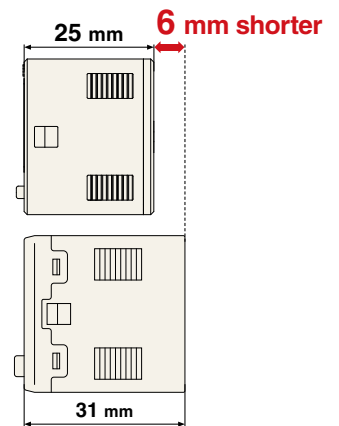

Functions pp. 40 to 42

- Output operation
- Simple setting mode
- Display color
- Delay time setting
- Digital filter setting
- FUNC output switching function
- Selectable analog output function
- External input function
- Forced output function
- Accumulated value hold
- Peak/Bottom value display
- Setting of a security code
- Key-lock function
- Reset to the default settings
- Display with zero cut-off setting
- Selection of the display on the sub screen
- Analog output free range function
- Error display function
- Copy function
- Selection of power saving mode

Mounting

The bracket configuration allows for mounting in four orientations.

Bracket A

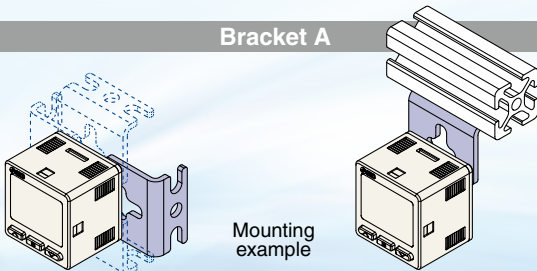

Bracket B

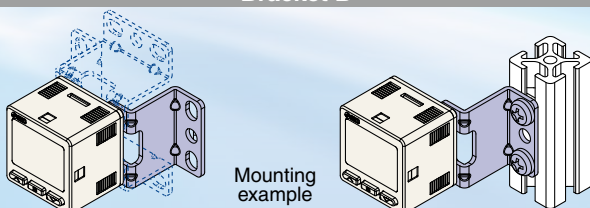

Panel mounting







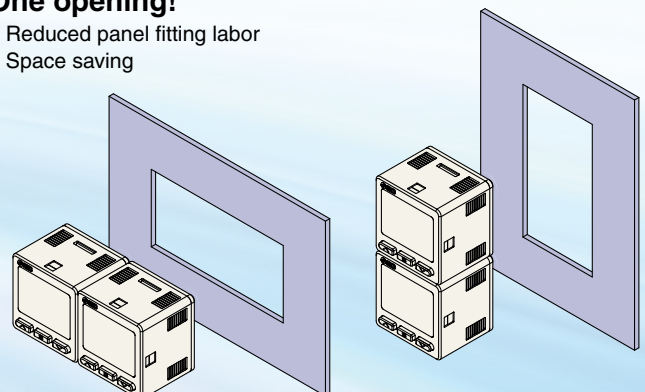

Mountable side by side both vertically and horizontally

One opening!

- Reduced panel fitting labor
- Space saving



Flow Switch Flow Rate Variations

Series	Compatibility with the PFG300 digital flow monitor	Applicable fluid	Detection method	Smallest settable increment	Rated flow range [L/min]																	
					0.1	0.2	0.5	1	2	5	10	20	25	50	100	150	200	300	500	600	1000	2000
PF2A 	—	Air N ₂	Thermal type (Thermistor)	0.1 L/min	1	10																
				0.5 L/min	5	50																
				1 L/min	10	100																
				2 L/min	20	200																
				5 L/min	50	500																
PF3A□H(-L)  Body ported type pp. 13, 15  PFG300 p. 31 Modular type pp. 17, 19	—	Air N ₂	Thermal type (Platinum sensor)	2 L/min	30	Body ported type															3000	
				5 L/min	60	Body ported type															6000	
				10 L/min	120	Body ported type															12000	
			Bypass flow type	1 L/min	10	Modular type															1000	
				2 L/min	20	Modular type															2000	
																	3000	6000	12000			
PF2M7(-L) 	—	Dry air N ₂ Ar CO ₂	Thermal type (MEMS)	0.001 L/min	0.01	1																
				0.01 L/min	0.02	2																
				0.01 L/min	0.05	5																
				0.01 L/min	0.1	10																
				0.01 L/min	0.3	25																
				0.1 L/min	0.5	50																
				0.1 L/min	1	100																
				1 L/min	2	200																
PFMB  PFG300 	—	Dry air N ₂	Thermal type (MEMS)	1 L/min	2	200																
				1 L/min	5	500																
			Bypass flow type	1 L/min	10	1000																
				1 L/min	20	2000																
PFMC(-L)  PFG300 	—	Dry air N ₂	Thermal type (MEMS) Bypass flow type	1 L/min	5	500																
				1 L/min	10	1000																
				1 L/min	20	2000																

Series	Applicable fluid	Detection method	Rated flow range [L/min]										
			-3	-2	-1	-0.5	0	0.5	1	2	3		
PFMV 	Dry air N ₂	Thermal type (MEMS)	0	0.5									
			0	1									
			0	3									
			-0.5	0.5									
			-1	1									
			-3	3									

Flow Switch Variations / Basic Performance Table

Series	PFMV	PF2M7(-L)	PFMB	PFMC(-L)	PF2A	PF3A□H(-L) p. 13
Enclosure	IP40	IP40	IP40	IP65 [Monitor unit: IP40]	IP65	IP65 [Monitor unit: IP40]
Fluid	Dry air, N ₂	Dry air, N ₂ , Ar, CO ₂	Dry air, N ₂	Dry air, N ₂	Air, N ₂	Air, N ₂
Setting	Digital	Digital	Digital	Digital	Digital	Digital
Rated flow range [L/min]	0 to 0.5 -0.5 to 0.5 0 to 1 -1 to 1 0 to 3 -3 to 3	0.01 to 1 0.02 to 2 0.05 to 5 0.1 to 10 0.3 to 25 0.5 to 50 1 to 100 2 to 200	2 to 200 5 to 500 10 to 1000 20 to 2000	5 to 500 10 to 1000 20 to 2000	1 to 10 5 to 50 10 to 100 20 to 200 50 to 500	30 to 3000 10 to 1000 60 to 6000 20 to 2000 120 to 12000
Power supply voltage	12 to 24 VDC ±10%	PF2M7 12 to 24 VDC ±10% PF2M7-L 18 to 30 VDC ±10%	12 to 24 VDC ±10%	PFMC 12 to 24 VDC ±10% PFMC-L 18 to 30 VDC ±10%	12 to 24 VDC ±10%	PF3A7□H 24 VDC ±10% PF3A7□H-L 18 to 30 VDC ±10% PF3A701H/702H-L 21.6 to 30 VDC PF3A8□H-L 21.6 to 30 VDC
Temperature characteristics (25°C standard)	±2% F.S. (15 to 35°C) [Monitor unit: ±0.5% F.S. (0 to 50°C)] ±5% F.S. (0 to 50°C)	±3% F.S. ±1 digit (15 to 35°C) ±5% F.S. ±1 digit (0 to 50°C)	±2% F.S. (15 to 35°C) [Monitor unit: ±0.5% F.S. (0 to 50°C)] ±5% F.S. (0 to 50°C)	±2% F.S. (15 to 35°C) [Monitor unit: ±0.5% F.S. (0 to 50°C)] ±5% F.S. (0 to 50°C)	±3% F.S. (15 to 35°C) ±5% F.S. (0 to 50°C)	±5% F.S. [Monitor unit: ±0.5% F.S. (0 to 50°C)]
Repeatability	±2% F.S. (Fluid: Dry air) [Monitor unit: ±0.1% F.S.] Analog output: ±5% F.S. [±0.3% F.S.]	±1% F.S. ±1 digit (Fluid: Dry air)	±1% F.S. (Fluid: Dry air) [Monitor unit: ±0.1% F.S.]	±1% F.S. (Fluid: Dry air) [Monitor unit: ±0.1% F.S.]	±1% F.S. (PF2A7□0) ±2% F.S. (PF2A7□1)	±1% F.S. [Monitor unit: ±0.1% F.S.]
Hysteresis	Hysteresis mode: Variable Window comparator mode: Variable	Hysteresis mode: Variable Window comparator mode: Variable	Hysteresis mode: Variable Window comparator mode: Variable	Hysteresis mode: Variable Window comparator mode: Variable	Hysteresis mode: Variable Window comparator mode: Fixed (3 digits)	Hysteresis mode: Variable Window comparator mode: Variable
Output	NPN/PNP open collector Analog voltage output Analog current output	NPN/PNP open collector Accumulated pulse output Analog voltage output Analog current output IO-Link	NPN/PNP open collector Accumulated pulse output Analog voltage output Analog current output	NPN/PNP open collector Accumulated pulse output Analog voltage output Analog current output IO-Link	NPN/PNP open collector Accumulated pulse output	NPN/PNP open collector Accumulated pulse output Analog voltage output Analog current output IO-Link
Display	[Monitor unit: 2-color LCD display]	2-color LCD display	2-color LED display 2-color LCD display [Monitor unit: 3-color LCD display]	3-color LCD display	LED display	3-color LCD display

* The monitor unit values are for the PFG300 and PFMV3.

CONTENTS



Body Ported Type

3-Color Display Digital Flow Switch *PF3A7□H Series*

Body Ported Type IO-Link Compatible

3-Color Display Digital Flow Switch *PF3A7□H-L Series*

Modular Type

3-Color Display Digital Flow Switch *PF3A7□H Series*

Modular Type IO-Link Compatible

3-Color Display Digital Flow Switch *PF3A7□H-L Series*

Modular Type IO-Link Compatible

4-Screen Display Digital Flow Switch with Pressure/Temperature Sensor
PF3A8□H-L Series

3-Screen Display Digital Flow Monitor *PFG300 Series*

Body Ported Type

3-Color Display Digital Flow Switch

PF3A7□H Series

How to Order p. 13

Specifications p. 14

Body Ported Type IO-Link Compatible

3-Color Display Digital Flow Switch

PF3A7□H-L Series

How to Order p. 15

Specifications p. 16

Modular Type

3-Color Display Digital Flow Switch

PF3A7□H Series

How to Order p. 17

Specifications p. 18

Modular Type IO-Link Compatible

3-Color Display Digital Flow Switch

PF3A7□H-L Series

How to Order p. 19

Specifications p. 20

Modular Type IO-Link Compatible

4-Screen Display Digital Flow Switch with Pressure/Temperature Sensor **PF3A8□H-L Series**

How to Order p. 21

Specifications p. 22

Flow Range p. 23

Analog Output p. 23

Pressure Loss p. 24

Flow Rate Characteristics p. 24

IN Side Straight Section and Accuracy p. 25

Temperature Accuracy p. 25

Internal Circuits and Wiring Examples p. 26

Construction: Parts in Contact with Fluid p. 28

Dimensions p. 28

Optional Accessories p. 30

3-Screen Display Digital Flow Monitor **PFG300 Series**

How to Order p. 31

Specifications p. 32

Internal Circuits and Wiring Examples p. 33

Dimensions p. 34

PF3A□H(-L)/Function Details p. 37

PFG300/Function Details p. 40

Safety Instructions Back cover

Body Ported Type PF3A□H(-L)

Modular Type PF3A□H(-L)

PFG300

Function Details

Body Ported Type

3-Color Display Digital Flow Switch

PF3A7□H Series

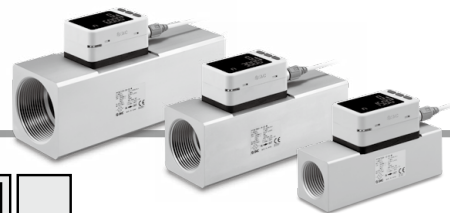

How to Order

PF3A7 03 H - □ 10 - CS □ - M □

Type

7	Integrated display
---	--------------------

Rated flow range

03	30 to 3000 L/min
06	60 to 6000 L/min
12	120 to 12000 L/min

Large flow type

Thread type

Nil	Rc
N	NPT
F*1	G

*1 ISO 1179-1 compliant

Port size

Symbol	Port size	Rated flow range		
		03	06	12
10	1	●	—	—
14	1 1/2	—	●	—
20	2	—	—	●

Calibration certificate*8

Nil	None
A*9	Yes

*8 The certificate is in both English and Japanese.

*9 Made to order

Unit specification

Nil	Units selection function*6
M	SI units only*7

*6 This product is for overseas use only. (The SI unit type is provided for use in Japan in accordance with the New Measurement Act.)

*7 Fixed units: Instantaneous flow: L/min
Accumulated flow: L

Options

Nil	With lead wire with M12 connector (3 m)*5
N	Without lead wire with M12 connector

*5 Options are shipped together with the product but do not come assembled.

Output specification

Symbol	OUT	FUNC*2	Applicable monitor unit model
CS	NPN	Analog voltage output*3 ⇔ External input*4	PFG300 series
DS	NPN	Analog current output ⇔ External input*4	PFG310 series
ES	PNP	Analog voltage output*3 ⇔ External input*4	PFG300 series
FS	PNP	Analog current output ⇔ External input*4	PFG310 series

*2 Analog output or external input can be selected by pressing the buttons. Analog output is set as default setting.

*3 1 to 5 V or 0 to 10 V can be selected by pressing the button. The default setting is 1 to 5 V.

*4 The accumulated value, peak value, and bottom value can be reset.

Option/Part No.

When only optional parts are required, order with the part number listed below.

Part no.	Option	Note
ZS-37-A	Lead wire with M12 connector	Length: 3 m

For flow switch precautions and specific product precautions, refer to the "Operation Manual" on the SMC website.

Specifications

Model		PF3A703H	PF3A706H	PF3A712H	
Fluid	Applicable fluid*1	Air, Nitrogen			
	Fluid temperature	0 to 50°C			
Flow	Detection method	Thermal type			
	Rated flow range	30 to 3000 L/min	60 to 6000 L/min	120 to 12000 L/min	
	Set point range*2	Instantaneous flow	30 to 3150 L/min	60 to 6300 L/min	120 to 12600 L/min
		Accumulated flow	0 to 999,999,999,990 L	0 to 999,999,999,900 L	
	Smallest settable increment	Instantaneous flow	2 L/min	5 L/min	10 L/min
		Accumulated flow	10 L	100 L	
	Accumulated volume per pulse (Pulse width = 50 ms)	Select from 100 L/pulse or 1000 L/pulse.			
Accumulated value hold function*3	Intervals of 2 or 5 minutes can be selected.				
Pressure	Rated pressure range	0.1 to 1.5 MPa			
	Proof pressure	2.25 MPa			
	Pressure loss	Refer to the "Pressure Loss" graph on page 24.			
	Pressure characteristics*4	±2.5% F.S. (0.1 to 1.0 MPa, 0.5 MPa standard)			
Electrical	Power supply voltage	24 VDC ±10%			
	Current consumption	150 mA or less			
	Protection	Polarity protection			
Accuracy	Display accuracy	±3.0% F.S.			
	Analog output accuracy	±3.0% F.S.			
	Repeatability	Switch output/Display: ±1.0% F.S. Analog output: ±1.0% F.S.			
	Temperature characteristics	±5.0% F.S. (Ambient temperature of 0 to 50°C, 25°C standard)			
Switch output	Output type	NPN open collector PNP open collector			
	Output mode	Select from Instantaneous output (Hysteresis mode or Window comparator mode), Accumulated output, or Accumulated pulse output.			
	Switch operation	Select from Normal or Reversed output.			
	Max. load current	80 mA			
	Max. applied voltage (NPN only)	28 VDC			
	Internal voltage drop (Residual voltage)	NPN output type: 1 V or less (at load current of 80 mA) PNP output type: 2 V or less (at load current of 80 mA)			
	Response time*5	Select from 1 s, 2 s, or 5 s.			
	Hysteresis*6	Variable from 0			
Analog output*7	Protection	Over current protection			
	Output type	Voltage output: 1 to 5 V (0 to 10 V can be selected*8), Current output: 4 to 20 mA			
	Impedance	Voltage output	Output impedance: Approx. 1 kΩ		
		Current output	Maximum load impedance: Approx. 600 Ω		
Response time*9	Linked to the response time of the switch output				
External input*10	Input type	No-voltage input: 0.4 V or less			
	Input mode	Select from Accumulated value external reset or Peak/Bottom value reset.			
	Input time	30 ms or longer			
Display	Reference condition*11	Select from Standard conditions or Normal conditions.			
	Unit*12	Instantaneous flow	L/min, CFM (ft ³ /min)		
		Accumulated flow	L, ft ³		
	Display range*13	Instantaneous flow (Flow under 30 L/min is displayed as "0")	0 to 3150 L/min (Flow under 60 L/min is displayed as "0")	0 to 6300 L/min (Flow under 120 L/min is displayed as "0")	0 to 12600 L/min (Flow under 120 L/min is displayed as "0")
		Accumulated flow*14	0 to 999,999,999,990 L	0 to 999,999,999,900 L	
	Minimum display unit	Instantaneous flow	2 L/min	5 L/min	10 L/min
		Accumulated flow	10 L	100 L	
Display	LCD, 2-screen display (Main screen/Sub screen) Main screen: Red/Green, Sub screen: Orange Main screen: 5 digits, 7 segment, Sub screen: 6 digits, 7 segment				
Indicator LED	OUT indicator: Red LED is ON when output is ON				
Environmental resistance	Enclosure	IP65			
	Withstand voltage	1000 VAC for 1 minute between terminals and housing			
	Insulation resistance	50 MΩ (500 VDC measured via megohmmeter) between terminals and housing			
	Operating temperature range	Operating: 0 to 50°C, Stored: -10 to 60°C (No freezing or condensation)			
Operating humidity range	Operating/Stored: 35 to 85% RH (No condensation)				
Standards	CE marking (EMC Directive, RoHS Directive)				
Piping	Piping specification	Rc1, NPT1, G1	Rc1 1/2, NPT1 1/2, G1 1/2	Rc2, NPT2, G2	
Main materials of parts in contact with fluid	Aluminum alloy, PPS, HNBR [Sensor: Pt, Au, Fe, Lead glass (exempted from the RoHS application), Al ₂ O ₃]				
Length of lead wire with connector	3 m				
Weight	Piping specification	Rc	610 g	1190 g	1680 g
		NPT	610 g	1190 g	1680 g
		G	630 g	1220 g	1720 g
	Lead wire with connector	+90 g			

*1 Air quality grade is JIS B 8392-1:2012 [4:6:-] and ISO 8573-1:2010 [4:6:-].
 *2 Set point range will change according to the setting of the zero cut-off function.
 *3 When using the accumulated value hold function, use the operating conditions to calculate the product life, and do not exceed it. The maximum update limit of the memory device is 1.5 million times. If the product is operated 24 hours per day, the product life will be as follows:
 - 5 min interval: life is calculated as 5 min x 1.5 million = 7.5 million min = 14.3 years
 - 2 min interval: life is calculated as 2 min x 1.5 million = 3 million min = 5.7 years
 If the accumulated value external reset is repeatedly used, the product life will be shorter than the calculated life.
 *4 When the pressure range is 1.0 to 1.5 MPa, the pressure characteristics will be ±5% F.S. (standard pressure is 0.5 MPa). Do not release the OUT side piping port of the product to the atmosphere without connecting piping. If the product is used with the piping port released to atmosphere, accuracy may vary.
 *5 The time from when the flow is changed by a step input (when the flow rate changes from 0 to the maximum value of the rated flow range instantaneously) until the switch output turns ON (or OFF) when set to be 90% of the rated flow rate

*6 If the flow fluctuates around the set value, the width for setting more than the fluctuating width needs to be set. Otherwise, chattering will occur.
 *7 Analog output or external input can be selected by pressing the buttons. Refer to the graph for analog output.
 *8 When selecting 0 to 10 V, refer to the analog output graph for the allowable load current.
 *9 The time from when the flow is changed by a step input (when the flow rate changes from 0 to the maximum value of the rated flow range instantaneously) until the analog output reaches 90% of the rated flow rate
 *10 Analog output or external input can be selected by pressing the buttons.
 *11 The flow rate given in the specifications is the value under standard conditions.
 *12 Setting is only possible for models with the units selection function.
 *13 Display range will change according to the setting of the zero cut-off function.
 *14 The accumulated flow display is the upper 6-digit and lower 6-digit (total of 12 digits) display. When the upper digits are displayed, x 10⁶ lights up.
 * Products with tiny scratches, marks, or display color or brightness variations which do not affect the performance of the product are verified as conforming products.

Body Ported Type  IO-Link

3-Color Display Digital Flow Switch

PF3A7□H-L Series



How to Order

PF3A 7 03 H - 10 - L Q - M

Type

7	Integrated display
---	--------------------

Rated flow range

03	30 to 3000 L/min
06	60 to 6000 L/min
12	120 to 12000 L/min

Large flow type

Thread type

Nil	Rc
N	NPT
F*1	G

*1 ISO 1179-1 compliant

Port size

Symbol	Port size	Rated flow range		
		03	06	12
10	1	●	—	—
14	1 1/2	—	●	—
20	2	—	—	●

Calibration certificate*9

Nil	None
A*10	Yes

*9 The certificate is in both English and Japanese.

*10 Made to order

Unit specification

Nil	Units selection function*7
M	SI units only*8

*7 This product is for overseas use only. (The SI unit type is provided for use in Japan in accordance with the New Measurement Act.)

*8 Fixed units: Instantaneous flow: L/min
Accumulated flow: L

Options

Nil	With lead wire with M12 connector (3 m)*5
N	Without lead wire with M12 connector
Q	Lead wire with M12-M12 connector (3 m)*6

*5 Options are shipped together with the product but do not come assembled.

*6 The lead wire has an M12 (female) connector on one side and an M12 (male) connector on the other side.

Output specification

Symbol	OUT	FUNC*2	Applicable monitor unit model
L	IO-Link: Switch output (N/P)	—	—
L3	IO-Link: Switch output (N/P)	Analog voltage output*3 ↔ External input*4	PFG300 series
L4	IO-Link: Switch output (N/P)	Analog current output ↔ External input*4	PFG310 series

*2 Analog output or external input can be selected by pressing the buttons. Analog output is set as default setting.

Output symbol "L" cannot be used as the FUNC terminal is not connected.

*3 1 to 5 V or 0 to 10 V can be selected by pressing the button. The default setting is 1 to 5 V.

*4 The accumulated value, peak value, and bottom value can be reset.

Options/Part Nos.

When only optional parts are required, order with the part numbers listed below.

Part no.	Option	Note
ZS-37-A	Lead wire with M12 connector	Length: 3 m
ZS-49-A	Lead wire with M12-M12 connector	Male/female conversion, Length: 3 m

For flow switch precautions and specific product precautions, refer to the "Operation Manual" on the SMC website.

Specifications

Model		PF3A703H-L	PF3A706H-L	PF3A712H-L
Electrical	Power supply voltage	When used as a switch output device	24 VDC ±10%	
		When used as an IO-Link device	18 to 30 VDC ±10%	
Switch output	Output type		Select from NPN or PNP open collector output.	
	Output mode		Select from Hysteresis, Window comparator, Accumulated output, Accumulated pulse output, Error output, or Switch output OFF modes.	
	Max. applied voltage		30 V (NPN output)	
	Internal voltage drop (Residual voltage)		1.5 V or less (at load current of 80 mA)	
	Delay time*1		3.3 ms or less, variable from 0 to 60 s/0.01 s increments	
Analog output	Response time*2		Linked to the set value of the digital filter	
Display	Display		LCD, 2-screen display (Main screen/Sub screen) Main screen: Red/Green, Sub screen: Orange Main screen/Sub screen: 9 digits (7 segments 7 digits, 11 segments 2 digits)	
	Digital filter*3		Select from 1 s, 2 s, or 5 s.	
Standards		CE marking (EMC Directive, RoHS Directive)		

*1 The time from when the instantaneous flow reaches the set value to when the switch output operates can be set.

*2 The time from when the flow is changed by a step input (when the flow rate changes from 0 to the maximum value of the rated flow range instantaneously) until the analog output reaches 90% of the rated flow rate

*3 The time for the digital filter can be set to the sensor input. The response time indicates when the set value is 90% in relation to the step input.

Communication Specifications (IO-Link mode)

IO-Link type	Device
IO-Link version	V 1.1
Communication speed	COM2 (38.4 kbps)
Configuration file	IODD file*1
Minimum cycle time	3.3 ms
Process data length	Input data: 4 bytes, Output data: 0 byte
On request data communication	Yes
Data storage function	Yes
Event function	Yes
Vendor ID	131 (0 x 0083)
Device ID*2	PF3A703H-□□-L□-□□ : 400 (0 x 0190)
	PF3A703H-□□-L3□-□□: 401 (0 x 0191)
	PF3A703H-□□-L4□-□□: 402 (0 x 0192)
	PF3A706H-□□-L□-□□ : 403 (0 x 0193)
	PF3A706H-□□-L3□-□□: 404 (0 x 0194)
	PF3A706H-□□-L4□-□□: 405 (0 x 0195)
	PF3A712H-□□-L□-□□ : 406 (0 x 0196)
	PF3A712H-□□-L3□-□□: 407 (0 x 0197)
PF3A712H-□□-L4□-□□: 408 (0 x 0198)	

*1 The configuration file can be downloaded from the SMC website, <https://www.smcworld.com>

*2 The device ID differs according to each product type (output specification).

Other specifications that are not listed are the same as those of the standard product. For details, refer to page 14.

Body Ported Type PF3A□H(-L)

Modular Type PF3A□H(-L)

PFG300

Function Details

Modular Type

3-Color Display Digital Flow Switch

PF3A7□H Series



How to Order

PF3A 7 01 H - CS □ - M □ - □

Type

7	Integrated display
---	--------------------

Rated flow range

Symbol	Rated flow range	Applicable air combination model
01	10 to 1000 L/min	AC30-D
02	20 to 2000 L/min	AC40-D

Large flow type

Output specification

Symbol	OUT	FUNC*1	Applicable monitor unit model
CS	NPN	Analog voltage output*2 ⇔ External input*3	PFG300 series
DS	NPN	Analog current output ⇔ External input*3	PFG310 series
ES	PNP	Analog voltage output*2 ⇔ External input*3	PFG300 series
FS	PNP	Analog current output ⇔ External input*3	PFG310 series

- *1 Analog output or external input can be selected by pressing the buttons. Analog output is set as default setting.
- *2 1 to 5 V or 0 to 10 V can be selected by pressing the button. The default setting is 1 to 5 V.
- *3 The accumulated value, peak value, and bottom value can be reset.

Options/Part Nos.

When only optional parts are required, order with the part numbers listed below.

Part no.	Option	Note
ZS-37-A	Lead wire with M12 connector	Length: 3 m
ZS-49-A	Lead wire with M12-M12 connector	Male/female conversion, Length: 3 m

Flow direction

Nil	Left to right
R	Right to left

Calibration certificate*8

Nil	None
A*9	Yes

- *8 The certificate is in both English and Japanese.
- *9 Made to order

Unit specification

Nil	Units selection function*6
M	SI units only*7

- *6 This product is for overseas use only. (The SI unit type is provided for use in Japan in accordance with the New Measurement Act.)
- *7 Fixed units: Instantaneous flow: L/min
Accumulated flow: L

Option*4

Nil	With lead wire with connector (3 m)
N	Without lead wire with connector
Q	Lead wire with M12-M12 connector (3 m)*5

- *4 Options are shipped together with the product but do not come assembled.
- *5 The lead wire has an M12 (female) connector on one side and an M12 (male) connector on the other side.

Caution on Mounting

Pipe threads are not provided for this product. If the product is to be used as a single unit, order a spacer (or spacer with bracket) and a piping adapter separately. Refer to page 30 for details on attachments.

Assembly Example

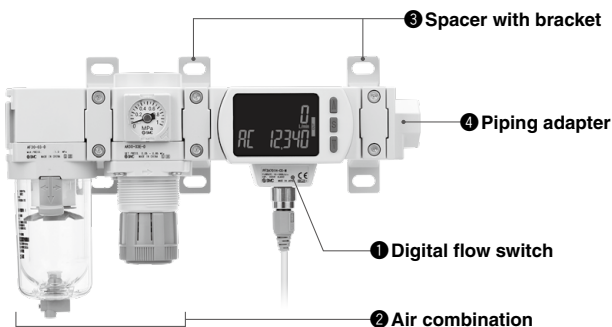

- * Avoid mounting the lubricator on the inlet side.
- * If a pressure relief 3-port valve is installed on the inlet side of the digital flow switch, causing a backflow of air, the measured value will change.

Assembly example

- ① Digital flow switch PF3A701H-CS-M 1 pc.
- ② Air combination AC30B-03E-D 1 pc.
- ③ Spacer with bracket Y300T-D 2 pcs.
- ④ Piping adapter E300-03-D 1 pc.

Products do not come assembled. They should be ordered separately and assembled by the customer.



Simple Specials System

A system designed to respond quickly and easily to your special ordering needs

Please contact your local sales representative for more details.

For flow switch precautions and specific product precautions, refer to the "Operation Manual" on the SMC website.

Specifications

Model		PF3A701H	PF3A702H	
Fluid	Applicable fluid*1	Air, Nitrogen		
	Fluid temperature	0 to 50°C		
Flow	Detection method	Thermal type (Bypass flow type)		
	Rated flow range	10 to 1000 L/min	20 to 2000 L/min	
	Set point range*2	Instantaneous flow	10 to 1050 L/min	20 to 2100 L/min
		Accumulated flow	0 to 999,999,999,990 L	
	Smallest settable increment	Instantaneous flow	1 L/min	2 L/min
		Accumulated flow	10 L	
	Accumulated volume per pulse (Pulse width = 50 ms)	Select from 10 L/pulse or 100 L/pulse.		
Accumulated value hold function*3	Intervals of 2 or 5 minutes can be selected.			
Pressure	Rated pressure range	0 to 1.0 MPa		
	Proof pressure	1.5 MPa		
	Pressure loss	Refer to the "Pressure Loss" graph on page 24.		
	Pressure characteristics*4	±5.0% F.S. (0 to 1.0 MPa, 0.5 MPa standard)		
Electrical	Power supply voltage	24 VDC ±10%		
	Current consumption	150 mA or less		
	Protection	Polarity protection		
Accuracy	Display accuracy*5	±3.0% F.S.		
	Analog output accuracy*5	±3.0% F.S.		
	Repeatability	±1.0% F.S.		
	Temperature characteristics	±5.0% F.S. (Ambient temperature of 0 to 50°C, 25°C standard)		
	Effects of connecting modular products*6	±5.0% F.S.		
Switch output	Output type	NPN open collector, PNP open collector		
	Output mode	Select from Instantaneous output (Hysteresis mode or Window comparator mode), Accumulated output, or Accumulated pulse output.		
	Switch operation	Select from Normal or Reversed output.		
	Max. load current	80 mA		
	Max. applied voltage (NPN only)	28 VDC		
	Internal voltage drop (Residual voltage)	NPN output type: 1 V or less (at load current of 80 mA), PNP output type: 2 V or less (at load current of 80 mA)		
	Response time*7	Select from 1 s, 2 s, or 5 s.		
	Hysteresis*8	Variable from 0		
	Protection	Over current protection		
Analog output*9	Output type	Voltage output: 1 to 5 V (0 to 10 V can be selected*10), Current output: 4 to 20 mA		
	Impedance	Voltage output	Output impedance: Approx. 1 kΩ	
		Current output	Maximum load impedance: 600 Ω, Minimum load impedance: 50 Ω	
Response time*11	Linked to the response time of the switch output			
External input*12	Input type	No-voltage input: 0.4 V or less		
	Input mode	Select from Accumulated value external reset or Peak/Bottom value reset.		
	Input time	30 ms or longer		
Display	Reference condition*13	Select from Standard conditions or Normal conditions.		
	Unit*14	Instantaneous flow	L/min, CFM (ft ³ /min)	
		Accumulated flow	L, ft ³	
	Display range*15	Instantaneous flow	0 to 1050 L/min (Flow under 10 L/min is displayed as "0")	0 to 2100 L/min (Flow under 20 L/min is displayed as "0")
		Accumulated flow*16	0 to 999,999,999,990 L	
	Minimum display unit	Instantaneous flow	1 L/min	2 L/min
		Accumulated flow	10 L	
Display	LCD, 2-screen display (Main screen/Sub screen) Main screen: Red/Green, Sub screen: Orange Main screen: 4 digits, 7 segment, Sub screen: 6 digits, 7 segment			
Environmental resistance	Indicator LED	OUT indicator: Red LED is ON when output is ON		
	Enclosure	IP65		
	Withstand voltage	1000 VAC for 1 minute between terminals and housing		
	Insulation resistance	50 MΩ (500 VDC measured via megohmmeter) between terminals and housing		
	Operating temperature range	Operating: 0 to 50°C, Stored: -10 to 60°C (No freezing or condensation)		
Operating humidity range	Operating/Stored: 35 to 85% RH (No condensation)			
Standards	CE marking (EMC Directive, RoHS Directive)			
Piping	Piping specification	Modular (Body size: 30)	Modular (Body size: 40)	
Main materials of parts in contact with fluid	Stainless steel 304, Aluminum alloy, PPS, HNBR [Sensor: Pt, Au, Ni, Fe, Lead glass (exempted from the RoHS application), Al ₂ O ₃]			
Length of lead wire with connector	3 m			
Weight	Body	350 g	400 g	
	Lead wire with connector	+90 g		

- *1 Air quality grade is JIS B 8392-1:2012 [4:6:-] and ISO 8573-1:2010 [4:6:-].
- *2 Set point range will change according to the setting of the zero cut-off function.
- *3 When using the accumulated value hold function, use the operating conditions to calculate the product life, and do not exceed it. The maximum update limit of the memory device is 1.5 million times. If the product is operated 24 hours per day, the product life will be as follows:
 · 5 min interval: life is calculated as 5 min x 1.5 million = 7.5 million min = 14.3 years
 · 2 min interval: life is calculated as 2 min x 1.5 million = 3 million min = 5.7 years
 If the accumulated value external reset is repeatedly used, the product life will be shorter than the calculated life.
- *4 Do not release the OUT side piping part of the product to the atmosphere without connecting piping. If the product is used with the piping port released to atmosphere, accuracy may vary.
- *5 The value when connecting a product with a port size of 3/8 (PF3A701H) or 1/2 (PF3A702H)
- *6 The value when the port size of the modular product is 3/8 (PF3A701H) or 1/2 (PF3A702H) and the product is operated at a supply pressure of 0.5 MPa
- *7 The time from when the flow is changed by a step input (when the flow rate changes from 0 to the maximum value of the rated flow range instantaneously) until the switch output turns ON (or OFF) when set to be 90% of the rated flow rate

- *8 If the flow fluctuates around the set value, the width for setting more than the fluctuating width needs to be set. Otherwise, chattering will occur.
- *9 Analog output or external input can be selected by pressing the buttons. Refer to the graph for analog output.
- *10 When selecting 0 to 10 V, refer to the analog output graph for the allowable load current.
- *11 The time from when the flow is changed by a step input (when the flow rate changes from 0 to the maximum value of the rated flow range instantaneously) until the analog output reaches 90% of the rated flow rate
- *12 Analog output or external input can be selected by pressing the buttons.
- *13 The flow rate given in the specifications is the value under standard conditions.
- *14 Setting is only possible for models with the units selection function.
- *15 Display range will change according to the setting of the zero cut-off function.
- *16 The accumulated flow display is the upper 6-digit and lower 6-digit (total of 12 digits) display. When the upper digits are displayed, x 10⁶ lights up.
- * Products with tiny scratches, marks, or display color or brightness variations which do not affect the performance of the product are verified as conforming products.

Modular Type  IO-Link

3-Color Display Digital Flow Switch

PF3A7□□H-L Series



How to Order

PF3A 7 01 H - L Q - M □ - □

• **Type**

7	Integrated display
---	--------------------

• **Rated flow range**

Symbol	Rated flow range	Applicable air combination model
01	10 to 1000 L/min	AC30-D
02	20 to 2000 L/min	AC40-D

• **Large flow type**

• **Output specification**

Symbol	OUT	FUNC*1	Applicable monitor unit model
L	IO-Link/ Switch output (N/P)	—	—
L3	IO-Link/ Switch output (N/P)	Analog voltage output*2 ↔ External input*3	PFG300 series
L4	IO-Link/ Switch output (N/P)	Analog current output ↔ External input*3	PFG310 series

- *1 Analog output or external input can be selected by pressing the buttons. Analog output is set as default setting.
- *2 1 to 5 V or 0 to 10 V can be selected by pressing the button. The default setting is 1 to 5 V.
- *3 The accumulated value, peak value, and bottom value can be reset.

• **Flow direction**

Nil	Left to right
R	Right to left

• **Calibration certificate***8

Nil	None
A*9	Yes

- *8 The certificate is in both English and Japanese.
- *9 Made to order

• **Unit specification**

Nil	Units selection function*6
M	SI units only*7

- *6 This product is for overseas use only. (The SI unit type is provided for use in Japan in accordance with the New Measurement Act.)
- *7 Fixed units: Instantaneous flow: L/min
Accumulated flow: L

• **Option***4

Nil	With lead wire with M12 connector (3 m)
N	Without lead wire with M12 connector
Q	Lead wire with M12-M12 connector (3 m)*5

- *4 Options are shipped together with the product but do not come assembled.
- *5 The lead wire has an M12 (female) connector on one side and an M12 (male) connector on the other side.

Options/Part Nos.

When only optional parts are required, order with the part numbers listed below.

Part no.	Option	Note
ZS-37-A	Lead wire with M12 connector	Length: 3 m
ZS-49-A	Lead wire with M12-M12 connector	Male/female conversion, Length: 3 m

Caution on Mounting

Pipe threads are not provided for this product. If the product is to be used as a single unit, order a spacer (or spacer with bracket) and a piping adapter separately. Refer to page 30 for details on attachments.

Assembly Example

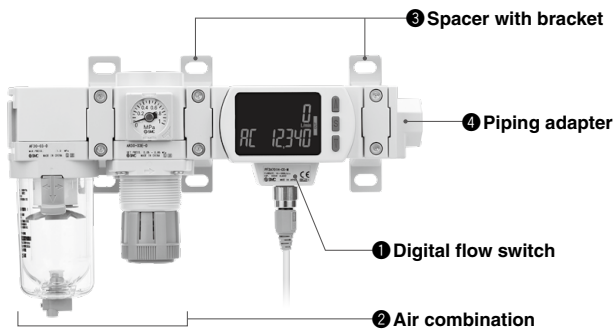

- * Avoid mounting the lubricator on the inlet side.
- * If a pressure relief 3-port valve is installed on the inlet side of the digital flow switch, causing a backflow of air, the measured value will change.

Assembly example

① Digital flow switch PF3A701H-L-M	1 pc.
② Air combination AC30B-03E-D	1 pc.
③ Spacer with bracket Y300T-D	2 pcs.
④ Piping adapter E300-03-D	1 pc.

Products do not come assembled. They should be ordered separately and assembled by the customer.



Simple Specials System

A system designed to respond quickly and easily to your special ordering needs

Please contact your local sales representative for more details.

For flow switch precautions and specific product precautions, refer to the "Operation Manual" on the SMC website.

Specifications

Model		PF3A701H-L	PF3A702H-L
Electrical	Power supply voltage	When used as a switch output device	24 VDC ±10%
		When used as an IO-Link device	21.6 to 30 VDC
Switch output	Output type		Select from NPN or PNP open collector output.
	Output mode		Select from Hysteresis, Window comparator, Accumulated output, Accumulated pulse output, Error output, or Switch output OFF modes.
	Max. applied voltage		30 V (NPN output)
	Internal voltage drop (Residual voltage)		1.5 V or less (at load current of 80 mA)
Analog output	Response time*2		Linked to the set value of the digital filter
	Display		LCD, 2-screen display (Main screen/Sub screen) Main screen: Red/Green, Sub screen: Orange Main screen/Sub screen: 9 digits (7 segments 7 digits, 11 segments 2 digits)
Standards		Digital filter*3	
		Select from 1 s, 2 s, or 5 s.	
		CE marking (EMC Directive, RoHS Directive)	

- *1 The time from when the instantaneous flow reaches the set value to when the switch output operates can be set.
- *2 The time from when the flow is changed by a step input (when the flow rate changes from 0 to the maximum value of the rated flow range instantaneously) until the analog output reaches 90% of the rated flow rate
- *3 The time for the digital filter can be set to the sensor input. The response time indicates when the set value is 90% in relation to the step input.

Communication Specifications (IO-Link mode)

IO-Link type	Device
IO-Link version	V 1.1
Communication speed	COM2 (38.4 kbps)
Configuration file	IODD file*1
Minimum cycle time	3.3 ms
Process data length	Input data: 4 bytes, Output data: 0 byte
On request data communication	Yes
Data storage function	Yes
Event function	Yes
Vendor ID	131 (0 x 0083)
Device ID*2	PF3A701H-□□-□□-□□ : 394 (0 x 018A)
	PF3A701H-□□-□□-□□ : 395 (0 x 018B)
	PF3A701H-□□-□□-□□ : 396 (0 x 018C)
	PF3A702H-□□-□□-□□ : 397 (0 x 018D)
	PF3A702H-□□-□□-□□ : 398 (0 x 018E)
	PF3A702H-□□-□□-□□ : 399 (0 x 018F)

- *1 The configuration file can be downloaded from the SMC website, <https://www.smcworld.com>
- *2 The device ID differs according to each product type (output specification).

Other specifications that are not listed are the same as those of the standard product. For details, refer to page 18.

Body Ported Type PF3A□H(-L)

Modular Type PF3A□H(-L)

PFG300

Function Details

Modular Type  IO-Link

4-Screen Display Digital Flow Switch with Pressure/Temperature Sensor

PF3A8□H-L Series



How to Order

PF3A 8 01 H-L2 Q-M □-□

● **Type**

8	With pressure/temperature sensor
---	----------------------------------

● **Rated flow range**

Symbol	Rated flow range	Applicable air combination model
01	10 to 1000 L/min	AC30-D
02	20 to 2000 L/min	AC40-D

● **Output specification**

Symbol	OUT1	OUT2
L2	IO-Link/Switch output (N/P)	Switch output (N/P)

● **Option*1**

Nil	With lead wire with M12 connector (3 m)
N	Without lead wire with M12 connector
Q	Lead wire with M12-M12 connector (3 m)*2

- *1 Options are shipped together with the product but do not come assembled.
- *2 The lead wire has an M12 (female) connector on one side and an M12 (male) connector on the other side.

● **Flow direction**

Nil	Left to right
R	Right to left

● **Calibration certificate*5
(For flow/pressure sensors only)**

Nil	None
A	Yes

- *5 The certificate is in both English and Japanese.
- * Made to order

● **Unit specification**

Nil	Units selection function*3
M	SI units only*4

- *3 This product is for overseas use only. (The SI unit type is provided for use in Japan in accordance with the New Measurement Act.)
- *4 Fixed units: Instantaneous flow: L/min
Accumulated flow : L
Pressure : kPa, MPa
Temperature : °C

Options/Part Nos.

When only optional parts are required, order with the part numbers listed below.

Part no.	Option	Note
ZS-37-A	Lead wire with M12 connector	Length: 3 m
ZS-49-A	Lead wire with M12-M12 connector	Male/female conversion, Length: 3 m

Caution on Mounting

Pipe threads are not provided for this product. If the product is to be used as a single unit, order a spacer (or spacer with bracket) and a piping adapter separately. Refer to page 30 for details on attachments.

Assembly Example

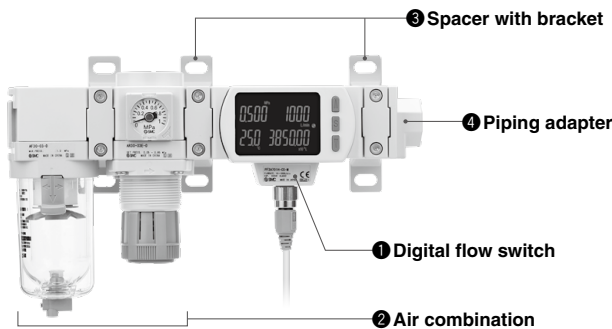

- * Avoid mounting the lubricator on the inlet side.
- * If a pressure relief 3-port valve is installed on the inlet side of the digital flow switch, causing a backflow of air, the measured value will change.

Assembly example

① Digital flow switch PF3A801H-L2-M	1 pc.
② Air combination AC30B-03E-D	1 pc.
③ Spacer with bracket Y300T-D	2 pcs.
④ Piping adapter E300-03-D	1 pc.

Products do not come assembled. They should be ordered separately and assembled by the customer.



Simple Specials System

A system designed to respond quickly and easily to your special ordering needs

Please contact your local sales representative for more details.

For flow switch precautions and specific product precautions, refer to the "Operation Manual" on the SMC website.

Specifications

Model		PF3A801H	PF3A802H	
Fluid	Applicable fluid*1	Air, Nitrogen		
	Fluid temperature	0 to 50°C		
Flow	Detection method	Thermal type (Bypass flow type)		
	Rated flow range	10 to 1000 L/min	20 to 2000 L/min	
	Set point range*2	Instantaneous flow	10 to 1050 L/min	20 to 2100 L/min
		Accumulated flow	0 to 9,999,999,990 L	
	Smallest settable increment	Instantaneous flow	1 L/min	2 L/min
		Accumulated flow	10 L	
	Accumulated volume per pulse (Pulse width = 50 ms)	Select from 10 L/pulse or 100 L/pulse.		
Accumulated value hold function*3	Intervals of 2 or 5 minutes can be selected.			
Pressure	Rated pressure range	0.000 to 1.000 MPa		
	Set pressure range*2	-0.050 to 1.050 MPa		
	Smallest settable increment	0.001 MPa		
	Proof pressure	1.5 MPa		
	Pressure loss	Refer to the "Pressure Loss" graph on page 24.		
Temperature	Rated temperature range	0.0 to 50.0°C		
	Set temperature range	-10.0 to 60.0°C		
	Smallest settable increment	0.1°C		
Electrical	Power supply voltage	21.6 to 30 VDC		
	Current consumption	150 mA or less		
Accuracy	Protection	Polarity protection		
		Accuracy	Flow rate*4	±3.0% F.S.
			Pressure	±3.0% F.S.
	Temperature*5	±2.5°C (Flow range: 100 to 1000 L/min, 200 to 2000 L/min)		
	Repeatability (Flow rate/Pressure)	±1.0% F.S.		
	Temperature characteristics (Flow rate/Pressure)	±5.0% F.S. (Ambient temperature of 0 to 50°C, 25°C standard)		
	Pressure characteristics (Flow rate)*6	±5.0% F.S. (0 to 1.0 MPa, 0.5 MPa standard)		
Effects of connecting modular products (Flow rate)*7	±5.0% F.S.			
Switch output	Output type	Select from NPN or PNP open collector. (2 outputs)		
	Output mode	Hysteresis mode, Window comparator mode, Error output, Output OFF, Accumulated output, Accumulated pulse output (Only flow rate)		
	Switch operation	Select from Normal or Reversed output.		
	Max. load current	80 mA		
	Max. applied voltage (NPN only)	30 VDC		
	Internal voltage drop (Residual voltage)	1.5 V or less (at load current of 80 mA)		
	Response time	5 ms or less		
	Delay time*8	Variable from 0 to 60 s/0.01 s increments		
	Hysteresis*9	Variable from 0		
	Protection	Over current protection		
Display	Reference condition*10	Select from Standard conditions or Normal conditions.		
	Unit*11	Instantaneous flow	L/min, CFM (ft³/min)	
		Accumulated flow	L, ft³	
		Pressure	MPa, KPa, kgf/cm², bar, psi	
		Temperature	°C, °F	
	Display range	Instantaneous flow	0 to 1050 L/min (Flow under 10 L/min is displayed as "0")	0 to 2100 L/min (Flow under 20 L/min is displayed as "0")
		Accumulated flow	0 to 9,999,999 x 10 ⁶ L (6-digit display) 0 to 9,999,999,999 x 10 ³ L (9-digit display)	
		Pressure*12	-0.050 to 1.050 MPa	
		Temperature	-10.0 to 60.0°C	
	Min. display unit	Instantaneous flow	1 L/min	2 L/min
		Accumulated flow	10 L	
		Pressure	0.001 MPa	
	Display	LCD, 4-screen display		
Upper line: Red/Green, Lower line: Orange Upper/Lower line: 10 digits (7 segments 5 digits, 11 segments 5 digits)				
Indicator LED	OUT indicator: Orange LED is ON when output is ON			
	Flow rate	1 s (2 s or 5 s can be selected.)		
	Pressure	0.1 s (Variable from 0 to 30 s/0.01 s increments)		
Digital filter*13	Temperature	1 s		
	Enclosure	IP65		
	Withstand voltage	1000 VAC for 1 minute between terminals and housing		
	Insulation resistance	50 MΩ (500 VDC measured via megohmmeter) between terminals and housing		
Environmental resistance	Operating temperature range	Operating: 0 to 50°C, Stored: -10 to 60°C (No freezing or condensation)		
	Operating humidity range	Operating/Stored: 35 to 85% RH (No condensation)		
Standards	CE marking (EMC Directive, RoHS Directive)			
Piping	Piping specification	Modular (Body size: 30)	Modular (Body size: 40)	
Main materials of parts in contact with fluid	Stainless steel 304, Aluminum alloy, PPS, HNBR [Sensor: Pt, Au, Ni, Fe, Lead glass (exempted from the RoHS application), Al ₂ O ₃]			
Length of lead wire with connector	3 m			
Weight	Body	350 g	400 g	
	Lead wire with connector	+90 g		

- *1 Air quality grade is JIS B 8392-1:2012 [4:6-] and ISO 8573-1:2010 [4:6-].
- *2 Set point range will change according to the setting of the zero cut-off function.
- *3 When using the accumulated value hold function, use the operating conditions to calculate the product life, and do not exceed it. The maximum update limit of the memory device is 1.5 million times. If the product is operated 24 hours per day, the product life will be as follows:
 - 5 min interval: life is calculated as 5 min x 1.5 million = 7.5 million min = 14.3 years
 - 2 min interval: life is calculated as 2 min x 1.5 million = 3 million min = 5.7 years
 If the accumulated value external reset is repeatedly used, the product life will be shorter than the calculated life.
- *4 The value when connecting a product with a port size of 3/8 (PF3A801H) or 1/2 (PF3A802H)
- *5 In the low flow rate range, the temperature value fluctuates (rises). Refer to the "Temperature Accuracy" graph on page 25.
- *6 Do not release the OUT side piping port of the product to the atmosphere without connecting piping. If the product is used with the piping port released to atmosphere, accuracy may vary.
- *7 The value when the port size of the modular product is 3/8 (PF3A801H) or 1/2 (PF3A802H) and the product is operated at a supply pressure of 0.5 MPa
- *8 The time from when the measured value reaches the set value to when the switch output operates can be set.
- *9 If the measured value fluctuates around the set value, the width for setting more than the fluctuating width needs to be set. Otherwise, chattering will occur.
- *10 The flow rate given in the specifications is the value under standard conditions.
- *11 Setting is only possible for models with the units selection function.
- *12 Display range will change according to the setting of the zero cut-off function.
- *13 The time for the digital filter can be set to the sensor input. The response time indicates when the set value is 90% in relation to the step input.
- *14 The configuration file can be downloaded from the SMC website, <https://www.smcworld.com>
- *15 The device ID differs according to each product type (output specification).
- * Products with tiny scratches, marks, or display color or brightness variations which do not affect the performance of the product are verified as conforming products.

Communication Specifications (IO-Link mode)

IO-Link type	Device
IO-Link version	V 1.1
Communication speed	COM2 (38.4 kbps)
Configuration file	IODD file*14
Minimum cycle time	5.8 ms
Process data length	Input data:12 bytes, Output data: 0 byte
On request data communication	Yes
Data storage function	Yes
Event function	Yes
Vendor ID	131 (0 x 0083)
Device ID*15	PF3A801H-L2□-□□□: 562 (0 x 0232)
	PF3A802H-L2□-□□□: 563 (0 x 0233)

PF3A□H(-L) Series

Flow Range

Model	Flow range				
	0 L/min	1000 L/min	3000 L/min	6000 L/min	12000 L/min
PF3A701H(-L) PF3A801H-L	10 L/min 10 L/min 0 L/min	1000 L/min 1050 L/min 1050 L/min			
PF3A702H(-L) PF3A802H-L	20 L/min 20 L/min 0 L/min	2000 L/min 2100 L/min 2100 L/min			
PF3A703H(-L)	30 L/min 30 L/min 0 L/min		3000 L/min 3150 L/min 3150 L/min		
PF3A706H(-L)	60 L/min 60 L/min 0 L/min			6000 L/min 6300 L/min 6300 L/min	
PF3A712H(-L)	120 L/min 120 L/min 0 L/min				12000 L/min 12600 L/min 12600 L/min

Rated flow range
 Set point range
 Display range

Analog Output

Flow/Analog Output

	0 L/min	A*2	B
Voltage output (1 to 5 V)*1	1 V	1.04 V	5 V
Current output*1	4 mA	4.16 mA	20 mA

	0 L/min	C*2	D
Voltage output (0 to 10 V)*1*3	0 V	0.1 V	10 V

Model	Min. value of the rated flow range*4	Max. value of the rated flow range
PF3A701H(-L)	10 L/min	1000 L/min
PF3A702H(-L)	20 L/min	2000 L/min
PF3A703H(-L)	30 L/min	3000 L/min
PF3A706H(-L)	60 L/min	6000 L/min
PF3A712H(-L)	120 L/min	12000 L/min

- *1 Analog output accuracy is within $\pm 3\%$ F.S.
- *2 A and C will change according to the setting of the zero cut-off function.
- *3 The analog output current from the connected equipment should be $20 \mu\text{A}$ or less when selecting 0 to 10 V. When more than $20 \mu\text{A}$ current flows, it is possible that the accuracy is not satisfied below 0.5 V.
- *4 The minimum value of the rated flow range will change according to the setting of the zero cut-off function.

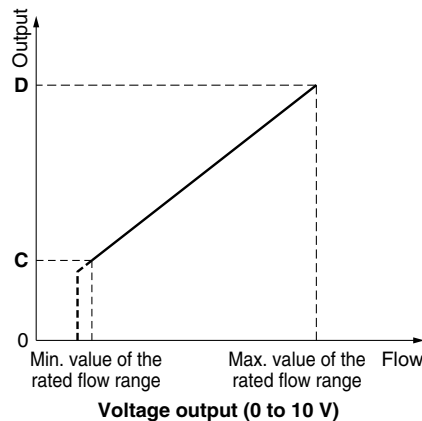
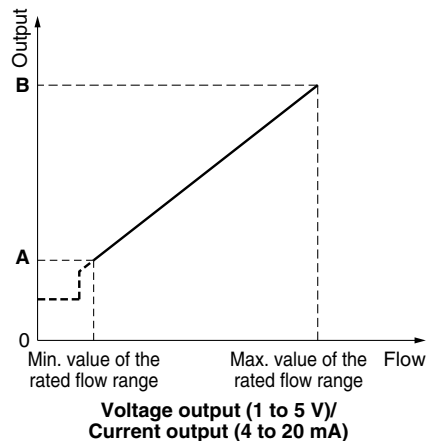

Pressure Loss (Reference Data)

PF3A701H(-L) (for 1000 L/min)
PF3A801H-L

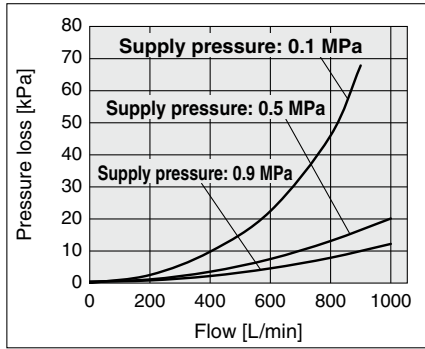

PF3A702H(-L) (for 2000 L/min)
PF3A802H-L

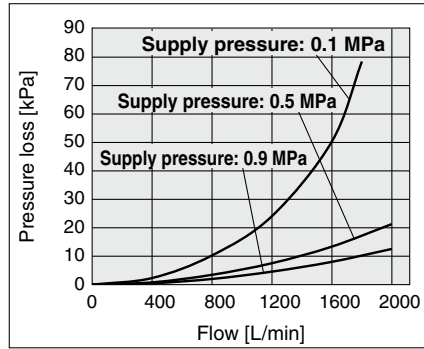

PF3A703H(-L) (for 3000 L/min)

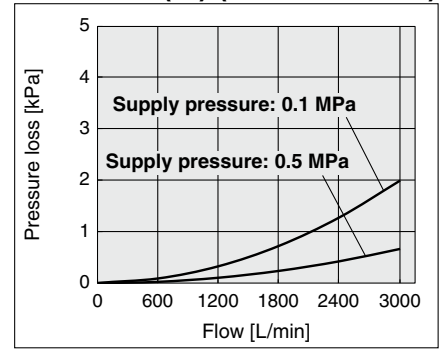

PF3A706H(-L) (for 6000 L/min)

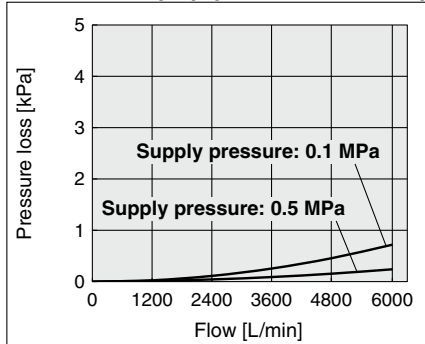

PF3A712H(-L) (for 12000 L/min)

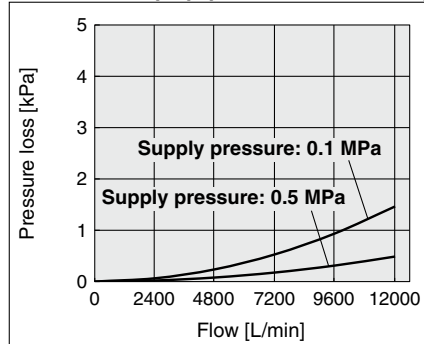

Flow Rate Characteristics (Reference Data)

AC30B-D + PF3A701H/PF3A801H-L Rc3/8

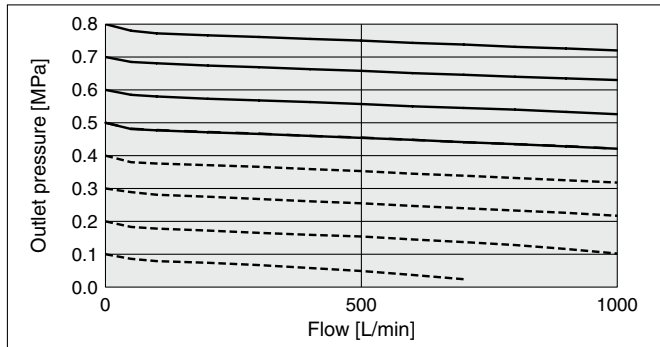

AC40B-D + PF3A702H/PF3A802H-L Rc1/2

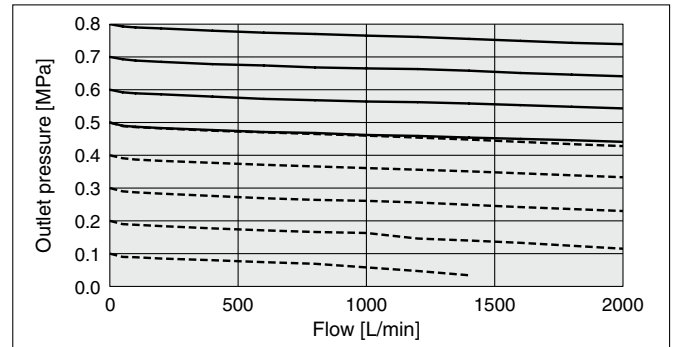

AW30-D + PF3A701H/PF3A801H-L Rc3/8

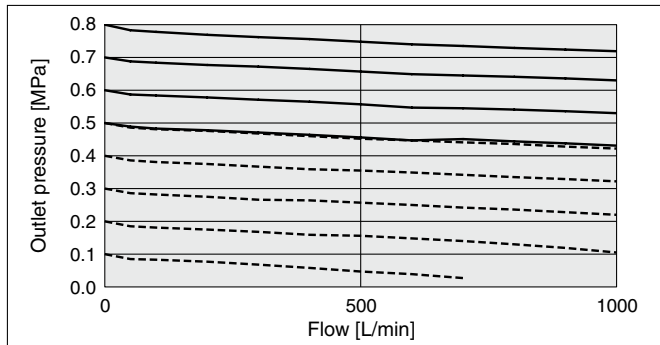

AW40-D + PF3A702H/PF3A802H-L Rc1/2

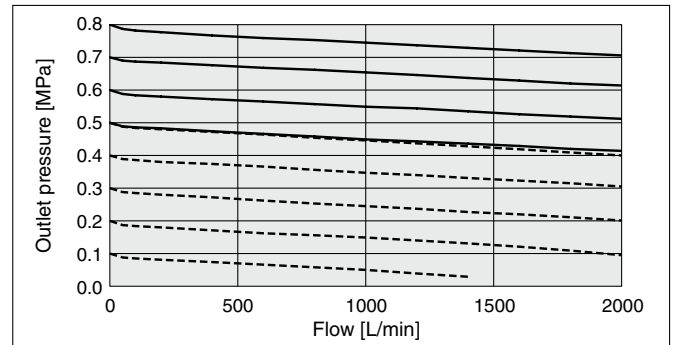

* This product cannot be used for applications in which the flow exceeds the rated flow range. Use caution when selecting a product.

Body Ported Type PF3A□H(-L)

Modular Type PF3A□H(-L)

PFG300

Function Details

PF3A□H(-L) Series

IN Side Straight Section and Accuracy (Reference Data)

PF3A703H(-L) (for 3000 L/min)

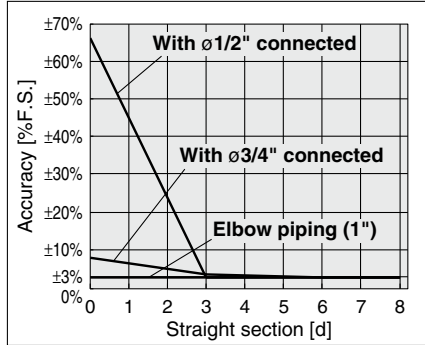

PF3A706H(-L) (for 6000 L/min)

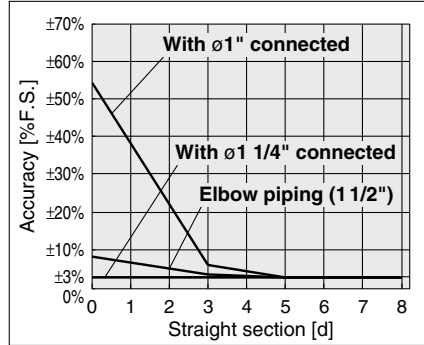

PF3A712H(-L) (for 12000 L/min)

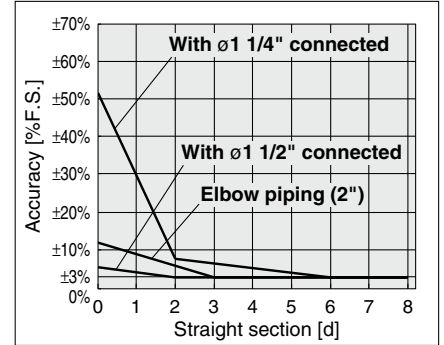

- Do not connect equipment or piping which may generate fluctuations in the flow or drift on the IN side of the product. When installing a regulator on the IN side of the product, make sure that chatter is not generated.
 - The piping on the IN side must have a straight section of piping whose length is more than 8 times the piping I.D.
- If a straight section of piping is not installed, the accuracy may vary by $\pm 3\%$ F.S. or more.
 * The "straight section" refers to a section of piping without any bends or rapid changes in the cross sectional area.

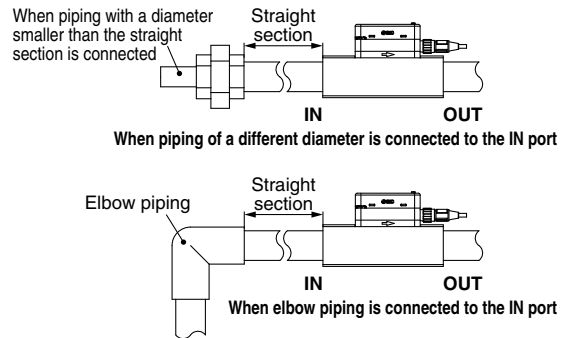

Temperature Accuracy (Reference Data)

PF3A801H/802H-L

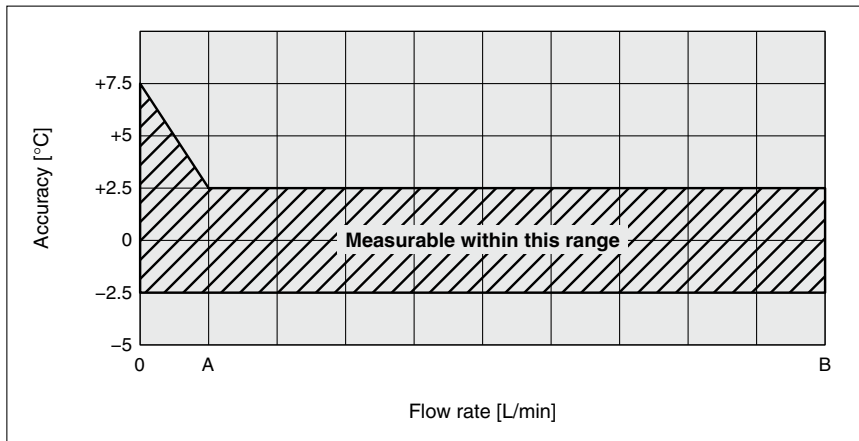

Model	A	B
PF3A801H-L	100 L/min	1000 L/min
PF3A802H-L	200 L/min	2000 L/min

< Temperature Measurement >

When there is no (low) fluid flow, the heat of the platinum sensor heated for flow detection is transmitted to the temperature sensor, so the temperature measurement value in the low flow range (less than 10% of the rated flow rate) tends to increase in relation to the fluid temperature.

< Detection Principle (Flow) >

When a heated platinum sensor is installed in the branch passage, and fluid flows through it, the fluid removes heat from the platinum sensor. The resistance value of the platinum sensor decreases as it loses heat. As the resistance value decrease ratio has a uniform relationship to the fluid flow, the flow rate can be detected by measuring the resistance value.

Internal Circuits and Wiring Examples

NPN + Analog output selected PF3A7□□H-□□-CS/DS□-□□

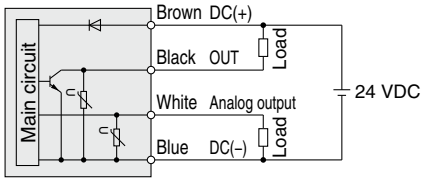

Max. applied voltage: 28 V, Max. load current: 80 mA, Internal voltage drop: 1 V or less
 CS: Analog output: 1 to 5 V or 0 to 10 V
 Output impedance: 1 kΩ
 DS: Analog output: 4 to 20 mA
 Max. load impedance: 600 Ω
 Min. load impedance: 50 Ω

PNP + Analog output selected PF3A7□□H-□□-ES/FS□-□□

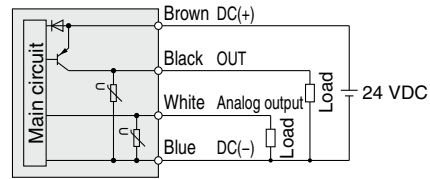

Max. load current: 80 mA, Internal voltage drop: 2 V or less
 ES: Analog output: 1 to 5 V or 0 to 10 V
 Output impedance: 1 kΩ
 FS: Analog output: 4 to 20 mA
 Max. load impedance: 600 Ω
 Min. load impedance: 50 Ω

NPN + External input selected PF3A7□□H-□□-CS/DS□-□□

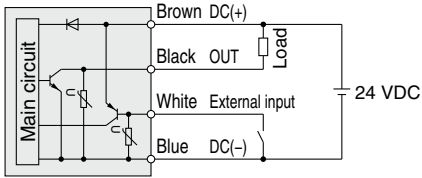

Max. applied voltage: 28 V, Max. load current: 80 mA, Internal voltage drop: 1 V or less
 External input: Input voltage 0.4 V or less (Reed or Solid state input) for 30 ms or longer

PNP + External input selected PF3A7□□H-□□-ES/FS□-□□

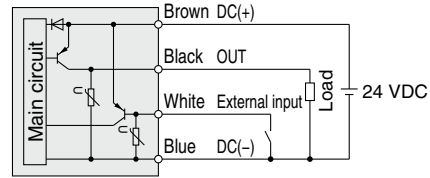

Max. load current: 80 mA, Internal voltage drop: 2 V or less
 External input: Input voltage 0.4 V or less (Reed or Solid state input) for 30 ms or longer

Accumulated pulse output wiring examples PF3A7□□H-□□-CS/DS□-□□

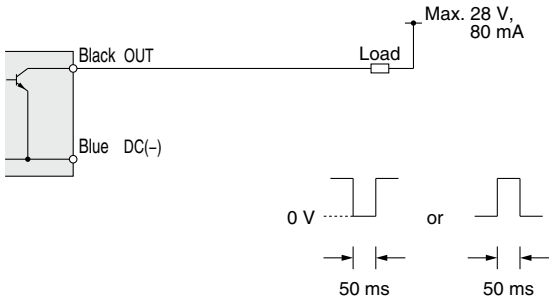

PF3A7□□H-□□-ES/FS□-□□

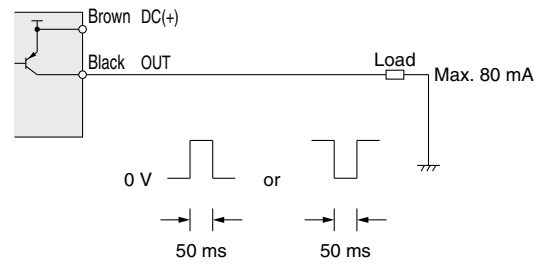

Body Ported Type PF3A□H(-L)

Modular Type PF3A□H(-L)

PFG300

Function Details

PF3A□H(-L) Series

Internal Circuits and Wiring Examples

PF3A7□□H-□□-L□-□□

NPN output type

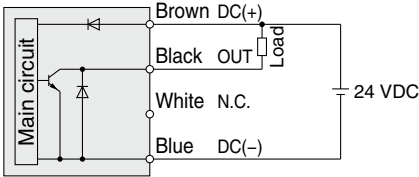

Max. applied voltage: 30 V, Max. load current: 80 mA, Internal voltage drop: 1.5 V or less

PNP output type

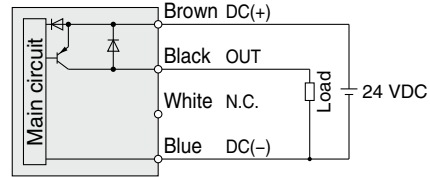

Max. load current: 80 mA, Internal voltage drop: 1.5 V or less

PF3A7□□H-□□-L3/L4□-□□

NPN + Analog output selected

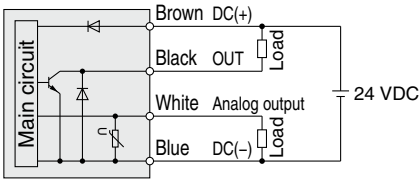

Max. applied voltage: 30 V, Max. load current: 80 mA, Internal voltage drop: 1.5 V or less

L3: Analog output: 1 to 5 V or 0 to 10 V

Output impedance: 1 kΩ

L4: Analog output: 4 to 20 mA

Max. load impedance: 600 Ω

Min. load impedance: 50 Ω

PNP + Analog output selected

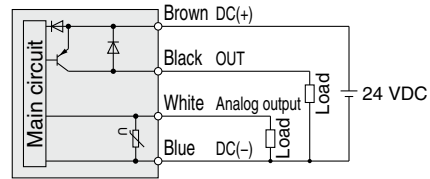

Max. load current: 80 mA, Internal voltage drop: 1.5 V or less

L3: Analog output: 1 to 5 V or 0 to 10 V

Output impedance: 1 kΩ

L4: Analog output: 4 to 20 mA

Max. load impedance: 600 Ω

Min. load impedance: 50 Ω

PF3A7□□H-□□-L3/L4□-□□

NPN + External input selected

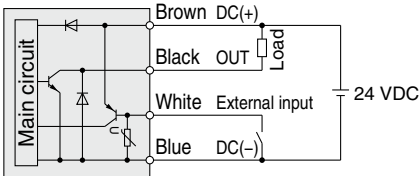

Max. applied voltage: 30 V, Max. load current: 80 mA, Internal voltage drop: 1.5 V or less

External input voltage: 0.4 V or less (Reed or Solid state input) for 30 ms or longer

PNP + External input selected

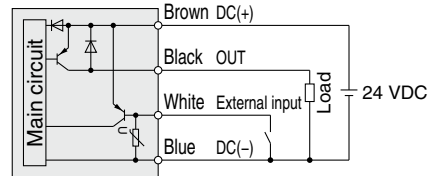

Max. load current: 80 mA, Internal voltage drop: 1.5 V or less
External input voltage: 0.4 V or less (Reed or Solid state input) for 30 ms or longer

PF3A8□-L2□-□

NPN 2 output type

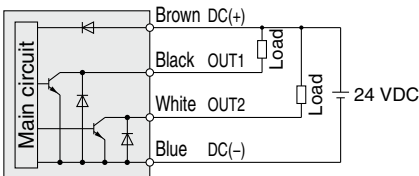

Max. applied voltage: 30 V, Max. load current: 80 mA, Internal voltage drop: 1.5 V or less

PNP 2 output type

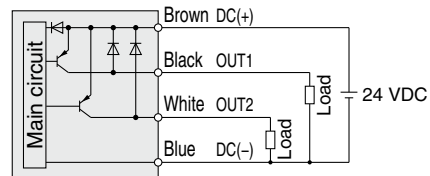

Max. load current: 80 mA, Internal voltage drop: 1.5 V or less

When used as an IO-Link device

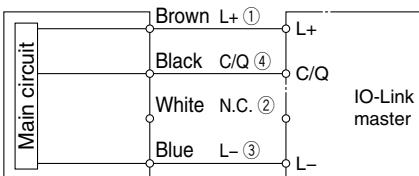

* The numbers in the diagram show the connector pin layout.

Construction: Parts in Contact with Fluid

PF3A703H(-L)/706H(-L)/712H(-L)

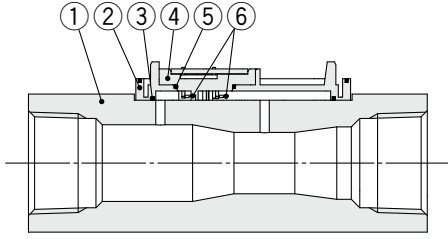

Component Parts

No.	Description	Material	Note
1	Body	Aluminum alloy	Anodized
2	Branch passage	PPS	—
3	Gasket	HNBR	—
4	Sensor base	PPS	—
5	Gasket	HNBR	—
6	Sensor	Au, Pt, Al ₂ O ₃	—

PF3A701H(-L)/702H(-L)

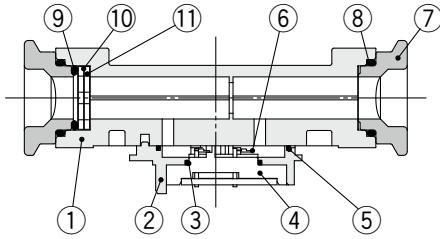

Component Parts

No.	Description	Material	Note
1	Body	ADC	
2	Branch passage	PPS	
3	Gasket	HNBR	
4	Sensor base	PPS	
5	Gasket	HNBR	
6	Sensor	Au, Pt, Al ₂ O ₃	
7	Attachment	ADC	
8	O-ring	HNBR	
9	O-ring	HNBR	
10	Mesh	Stainless steel 304	
11	Spacer	PPS	
12	Pressure sensor	Silicon, PPS	
13	O-ring	HNBR	

PF3A801H-L/802H-L

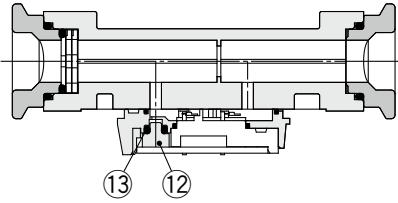

Dimensions

PF3A703H(-L)/706H(-L)/712H(-L)

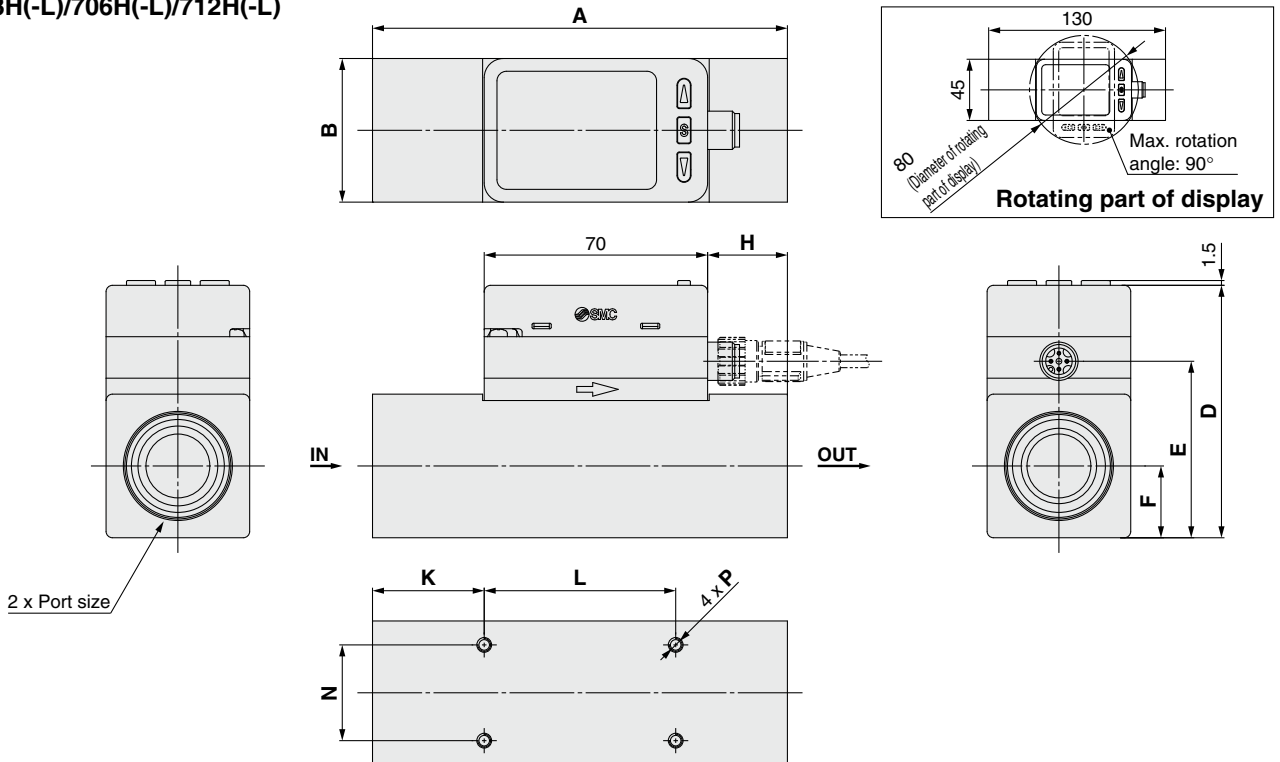

Model	Symbol	Port size	A	B	D	E	F	H	K	L	N	P
PF3A703H		Rc1, NPT1, G1	130	45	79.1	55.3	22.5	25	35	60	30	M4 x 0.7 depth 7
PF3A706H		Rc1 1/2, NPT1 1/2, G1 1/2	170	60	94.1	70.3	30	68	45	80	40	M5 x 0.8 depth 8
PF3A712H		Rc2, NPT2, G2	200	70	104.1	80.3	35	85	50	100	50	M6 x 1.0 depth 9

PF3A□H(-L) Series

Dimensions

PF3A701H/702H
PF3A801H/802H

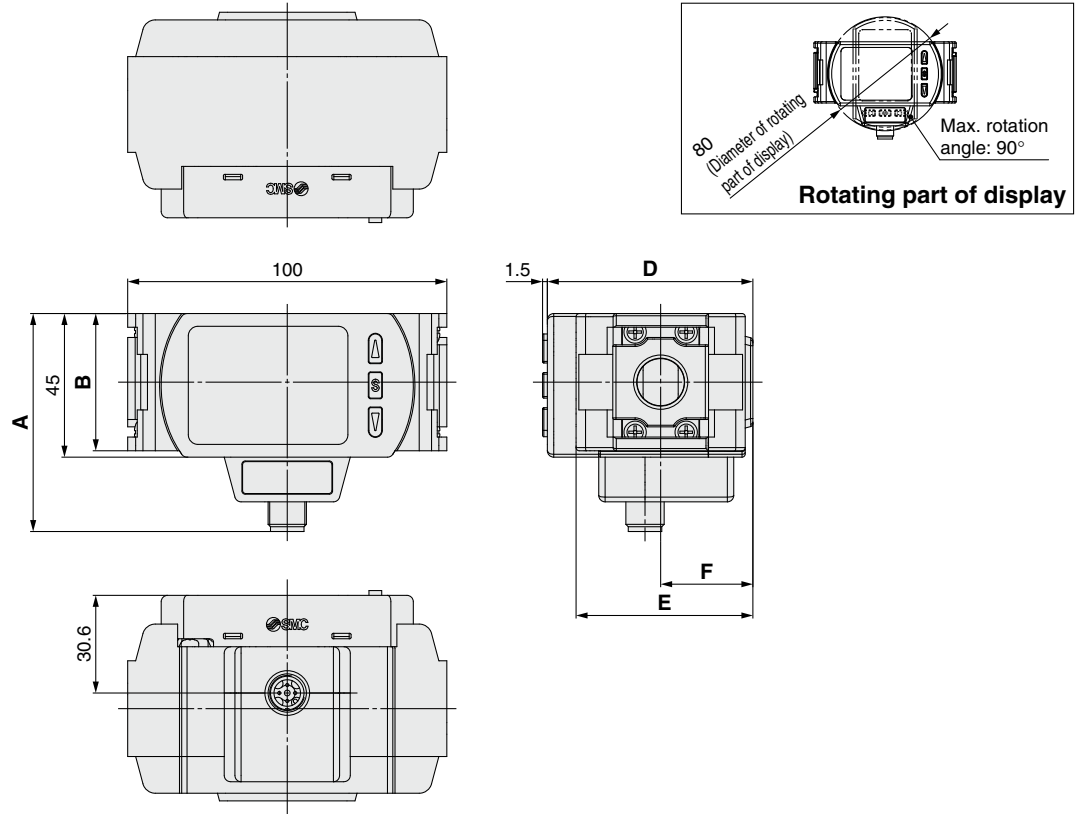

Model	Symbol	A	B	D	E	F
PF3A701H/PF3A801H		68.3	43	64.4	55.4	28.9
PF3A702H/PF3A802H		72.3	51	73	71	35.5

Lead wire with M12 connector (Part no.: ZS-37-A)

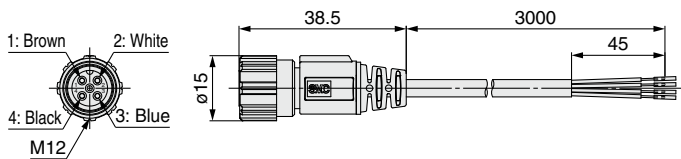

Cable Specifications

Conductor	Nominal cross section	AWG23
Insulator	Outside diameter	Approx. 1.1 mm
	Color	Brown, Blue, Black, White
Sheath	Finished outside diameter	ø4

Pin no.	Pin name	Wire color
1	DC(+)	Brown
2	FUNC	White
3	DC(-)	Blue
4	OUT(C/Q)	Black

* 4-wire type lead wire with M12 connector used for the PF3A series

Lead wire with M12-M12 connector (Part no.: ZS-49-A)

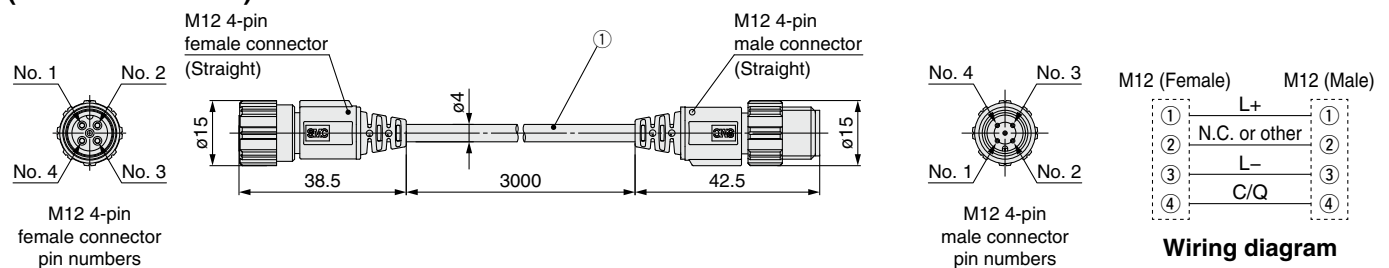

* For wiring, refer to the "Operation Manual" on the SMC website, <https://www.smcworld.com>

PF3A□H(-L) Series Optional Accessories

Piping Adapter: 1/4, 3/8, 1/2, 3/4

A piping adapter allows for the installation/removal of the component without removing the piping and thus makes maintenance easier.

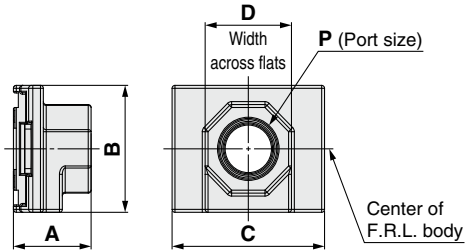

Model	P	A	B	C	D	Applicable air combination model
E300-□02-D	1/4	27	43	53	30	AC30-D
E300-□03-D	3/8					
E300-□04-D	1/2					
E400-□02-D	1/4	30	51	71	36	AC40-D
E400-□03-D	3/8					
E400-□04-D	1/2					
E400-□06-D	3/4					

* □ in model numbers indicates a pipe thread type. No indication is necessary for Rc; however, indicate N for NPT, and F for G.
* Separate spacers are required for modular unit.

Spacer/Spacer with Bracket

Spacer

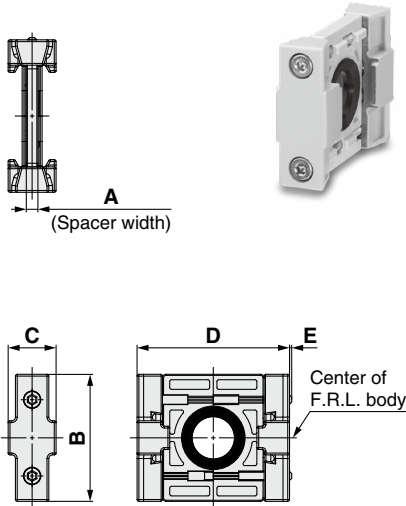

Model	A	B	C	D	E	Applicable air combination model
Y300-D	4.2	43	16.2	53	—	AC30-D
Y400-D	5.2	51	19.2	71	—	AC40-D

Spacer with bracket

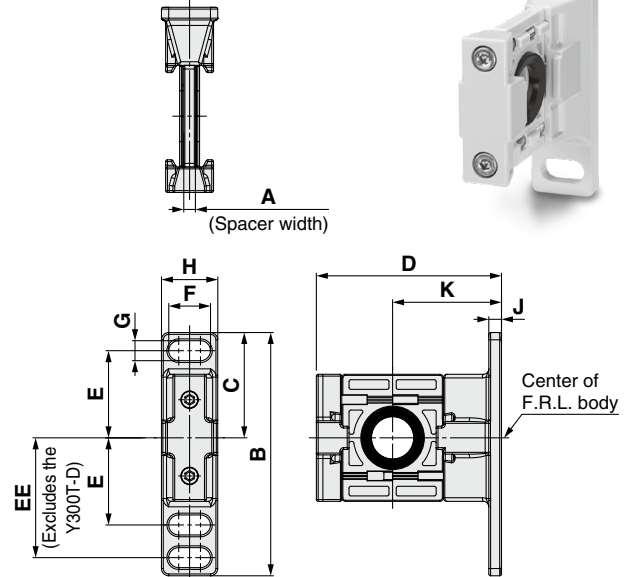

Model	A	B	C	D	E	EE	F	G	H	J	K	Applicable air combination model
Y300T-D	4.2	85	42.5	67.5	35	—	14	7	20	6	41	AC30-D
Y400T-D	5.2	115	50	85.5	40	55	18	9	26	7	50	AC40-D

Mounting Position Example

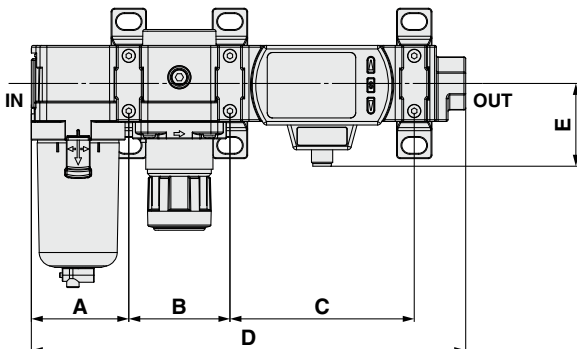

Applicable air combination model	A	B	C	D	E
AC30-D	55.1	57.2	104.2	245.6	46.8
AC40-D	72.6	75.2	105.2	285.6	46.8

Body Ported Type PF3A□H(-L)

Modular Type PF3A□H(-L)

PFG300

Function Details

3-Screen Display

Digital Flow Monitor

PFG300 Series



How to Order

PFG 3 0 0 - RT - M - L [] [] []

Type

3 Remote type monitor unit

Input specification

Symbol	Description	Applicable flow switch model
0	Voltage input	PF3A7□H-CS/ES/L3 series
1	Current input	PF3A7□H-DS/FS/L4 series

* The PFG3 (monitor unit) cannot be used as an IO-Link communication device.

Output specification

RT	2 outputs (NPN/PNP switching type) + Analog voltage output*1, 2
SV	2 outputs (NPN/PNP switching type) + Analog current output*2
XY	2 outputs (NPN/PNP switching type) + Copy function

*1 Can switch between 1 to 5 V and 0 to 10 V

*2 Can be switched to external input or copy function

Unit specification

Nil	Units selection function*3
M	SI units only*4

*3 This product is for overseas use only. (The SI unit type is provided for use in Japan in accordance with the New Measurement Act.)

*4 Fixed units: Instantaneous flow: L/min
Accumulated flow: L

Option 4

	Operation manual	Calibration certificate
Nil	○	—
Y	—	—
K	○	○
T	—	○

Option 3

Nil	None
C	ZS-28-CA-4 Sensor connector

Option 2

Symbol	Description	
Nil	None	
A1	Bracket A (Vertical mounting)	ZS-46-A1
A2	Bracket B (Horizontal mounting)	ZS-46-A2
B	Panel mount adapter	ZS-46-B
D	Panel mount adapter + Front protection cover	ZS-46-D

Option 1

Symbol	Description	
Nil	Without lead wire	
L	Power supply/output connection lead wire (Lead wire length: 2 m)	ZS-46-5L Power supply/output connection lead wire

Options/Part Nos.

When only optional parts are required, order with the part numbers listed below.

Part no.	Option	Note
ZS-28-CA-4	Sensor connector	For PF3A7□H
ZS-46-A1	Bracket A	Tapping screw: Nominal size 3 x 8 L (2 pcs.)
ZS-46-A2	Bracket B	Tapping screw: Nominal size 3 x 8 L (2 pcs.)
ZS-46-B	Panel mount adapter	
ZS-46-D	Panel mount adapter + Front protection cover	
ZS-46-5L	Power supply/output connection lead wire	5-core, 2 m
ZS-27-01	Front protection cover	

Connection Example

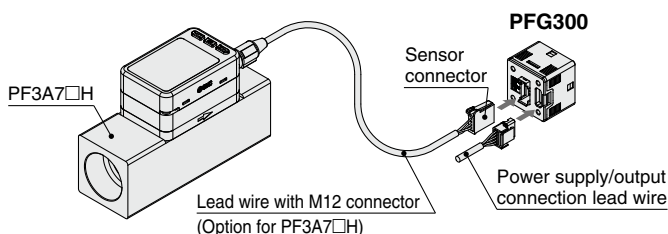

For flow switch precautions and specific product precautions, refer to the "Operation Manual" on the SMC website.

Specifications

Model		PFG300 series						
Applicable SMC flow switch	Model	PF3A701H	PF3A702H	PF3A703H	PF3A706H	PF3A712H		
	Rated flow range *1	10 to 1000 L/min	20 to 2000 L/min	30 to 3000 L/min	60 to 6000 L/min	120 to 12000 L/min		
Flow	Set point range	Instantaneous flow	-50 to 1050 L/min	-100 to 2100 L/min	-150 to 3150 L/min	-300 to 6300 L/min	-600 to 12600 L/min	
		Accumulated flow	0 to 999,999,999,990 L		0 to 999,999,999,990 L		0 to 999,999,999,990 L	
	Smallest settable increment	Instantaneous flow	1 L/min		2 L/min		5 L/min	
		Accumulated flow	10 L		10 L		100 L	
	Accumulated volume per pulse (Pulse width = 50 ms)		10 L/pulse		10 L/pulse		100 L/pulse	
	Accumulated value hold function *3	Intervals of 2 or 5 minutes can be selected. The stored accumulated flow is held even when the power supply is OFF.						
Electrical	Power supply voltage	12 to 24 VDC ±10% (24 VDC when the PF3A7□H is connected)						
	Current consumption	25 mA or less						
	Protection	Polarity protection						
Accuracy	Display accuracy	±0.5% F.S. ± Minimum display unit (Ambient temperature of 25°C)						
	Analog output accuracy	±0.5% F.S. (Ambient temperature of 25°C)						
	Repeatability	±0.1% F.S. ± Minimum display unit						
	Temperature characteristics	±0.5% F.S. (Ambient temperature: 0 to 50°C, 25°C standard)						
Switch output	Output type	Select from NPN or PNP open collector output.						
	Output mode	Select from Hysteresis, Window comparator, Accumulated output, Accumulated pulse output, Error output, or Switch output OFF modes.						
	Switch operation	Select from Normal or Reversed output.						
	Max. load current	80 mA						
	Max. applied voltage (NPN only)	30 VDC						
	Internal voltage drop (Residual voltage)	NPN output: 1 V or less (at load current of 80 mA), PNP output: 1.5 V or less (at load current of 80 mA)						
	Response time *2	3 ms or less						
	Delay time *2	Select from 0.00, 0.05 to 0.1 s (increment of 0.01 s), 0.1 to 1.0 s (increment of 0.1 s), 1 to 10 s (increment of 1 s), 20 s, 30 s, 40 s, 50 s, or 60 s.						
	Hysteresis *4	Variable from 0						
	Protection	Short circuit protection						
Analog output *5	Output type	Voltage output: 1 to 5 V, 0 to 10 V (only when the power supply voltage is 24 VDC) Current output: 4 to 20 mA (0 L/min to maximum value of the rated flow)						
	Impedance	Voltage output	Output impedance: 1 kΩ					
		Current output	Maximum load impedance: 300 Ω (at power supply voltage of 12 V), 600 Ω (at power supply voltage of 24 VDC)					
	Response time *2	50 ms or less						
External input *6	External input	Input voltage: 0.4 V or less (Reed or Solid state) for 30 ms or longer						
	Input mode	Select from Accumulated value external reset or Peak/Bottom value reset.						
Sensor input	Input type	Voltage input: 1 to 5 VDC (Input impedance: 1 MΩ), Current input: 4 to 20 mA DC (Input impedance: 51 Ω) (0 L/min to maximum value of the rated flow)						
	Connection method	Connector (e-CON)						
	Protection	Over voltage protection (Up to 26.4 VDC)						
Display	Display mode	Select from Instantaneous flow or Accumulated flow.						
	Unit *7	Instantaneous flow	L/min, cfm (ft ³ /min)					
		Accumulated flow	L, ft ³ , L x 10 ⁶ , ft ³ x 10 ⁶					
	Display range	Instantaneous flow	-50 to 1050 L/min	-100 to 2100 L/min	-150 to 3150 L/min	-300 to 6300 L/min	-600 to 12600 L/min	
		Accumulated flow*9	0 to 999,999,999,990 L		0 to 999,999,999,990 L		0 to 999,999,999,990 L	
	Minimum display unit	Instantaneous flow	1 L/min		2 L/min		5 L/min	
		Accumulated flow	10 L		10 L		100 L	
	Display type	LCD						
	Number of displays	3-screen display (Main screen, Sub screen)						
Display color	1) Main screen: Red/Green, 2) Sub screen: Orange							
Number of display digits	1) Main screen: 5 digits (7 segments), 2) Sub screen: 9 digits (7 segments)							
Indicator LED	LED ON when switch output is ON. OUT1/2: Orange							
Digital filter *8	Select from 0.00, 0.05 to 0.1 s (increment of 0.01 s), 0.1 to 1.0 s (increment of 0.1 s), 1 to 10 s (increment of 1 s), 20 s, or 30 s.							
Environment	Enclosure	IP40						
	Withstand voltage	1000 VAC for 1 minute between terminals and housing						
	Insulation resistance	50 MΩ or more (500 VDC measured via megohmmeter) between terminals and housing						
	Operating temperature range	Operating: 0 to 50°C, Stored: -10 to 60°C (No condensation or freezing)						
Standards	Operating/Stored: 35 to 85% RH (No condensation or freezing)							
Weight	Body	CE marking (EMC directive/RoHS directive)						
	Lead wire with connector	25 g (Excluding the power supply/output connection lead wire) +39 g						

*1 Rated flow range of the applicable flow switch
 *2 Value without digital filter (at 0.00 s)
 *3 When using the accumulated value hold function, use the operating conditions to calculate the product life, and do not exceed it. The maximum access limit of the memory device is 1.5 million times. If the product is operated 24 hours per day, the product life will be as follows:
 • 5 min interval: life is calculated as 5 min x 1.5 million = 7.5 million min = 14.3 years
 • 2 min interval: life is calculated as 2 min x 1.5 million = 3 million min = 5.7 years
 If the accumulated value external reset is repeatedly used, the product life will be shorter than the calculated life.
 *4 If the flow fluctuates around the set value, the width for setting more than the fluctuating width needs to be set. Otherwise, chattering will occur.
 *5 Setting is only possible for models with analog output.
 *6 Setting is only possible for models with external input.
 *7 Setting is only possible for models with the units selection function.
 *8 The response time indicates when the set value is 90% in relation to the step input.
 *9 The accumulated flow display is the upper 6-digit and lower 6-digit (total of 12 digits) display. When the upper digits are displayed, x 10⁶ lights up.
 * Products with tiny scratches, marks, or display color or brightness variations which do not affect the performance of the product are verified as conforming products.

Body Ported Type PFG300□H(-L)

Modular Type PFG300□H(-L)

PFG300

Function Details

PF300 Series

Internal Circuits and Wiring Examples

-XY
-RT
-SV
NPN (2 outputs) + Copy function

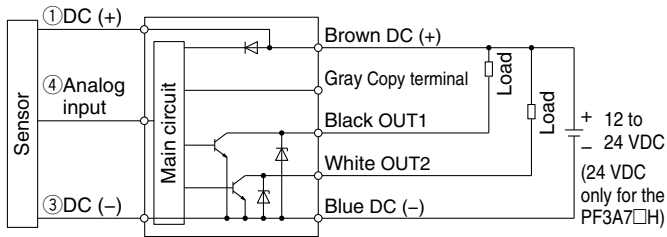

-XY
-RT
-SV
PNP (2 outputs) + Copy function

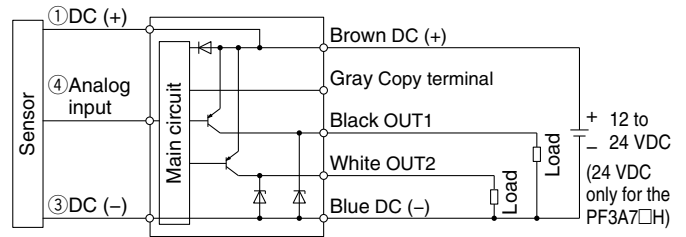

-RT: NPN (2 outputs) + Analog voltage output
-SV: NPN (2 outputs) + Analog current output

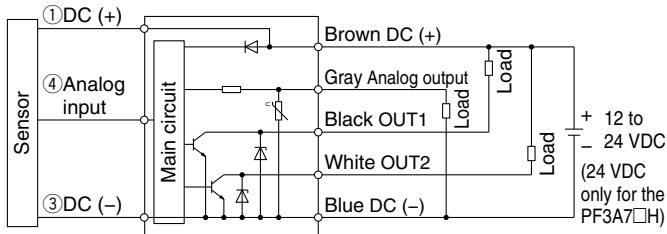

-RT: PNP (2 outputs) + Analog voltage output
-SV: PNP (2 outputs) + Analog current output

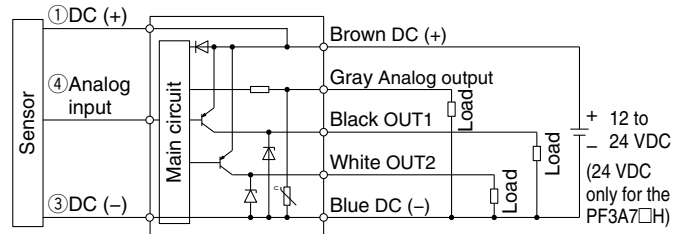

-RT: NPN (2 outputs) + External input
-SV: NPN (2 outputs) + External input

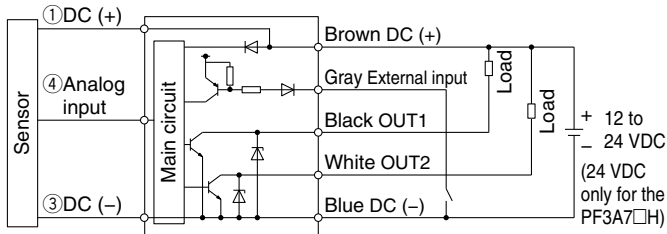

-RT: PNP (2 outputs) + External input
-SV: PNP (2 outputs) + External input

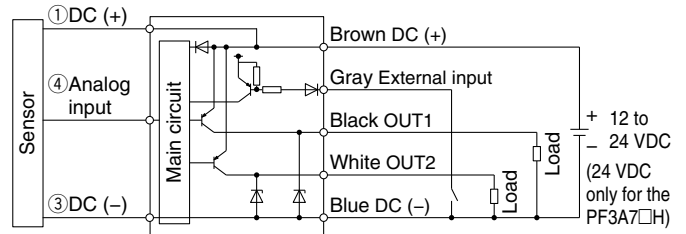

Accumulated pulse output wiring examples

NPN (2 outputs) type

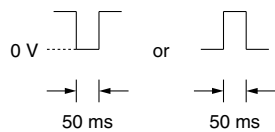
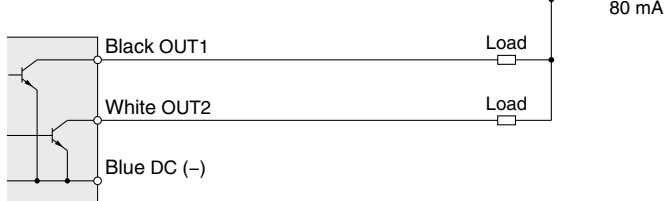

PNP (2 outputs) type

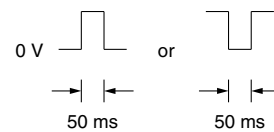
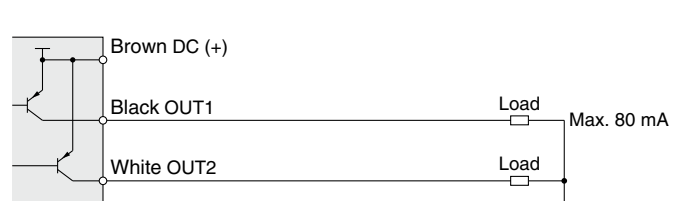

Dimensions

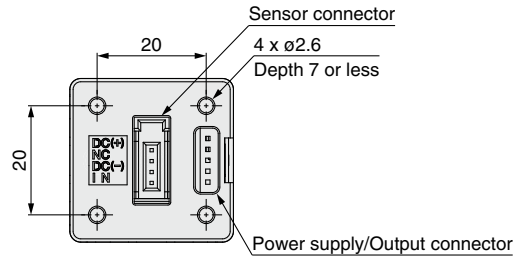
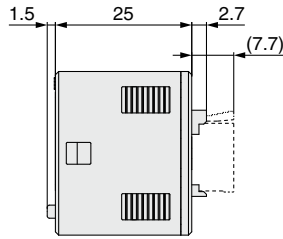
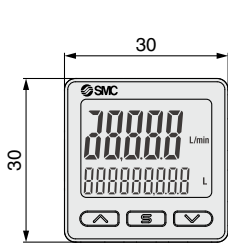

Bracket A
(Part no.: ZS-46-A1)

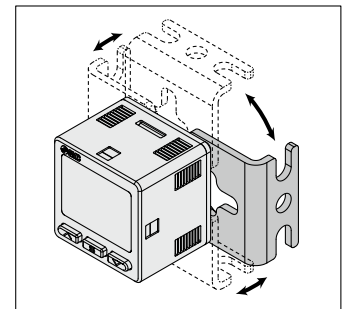
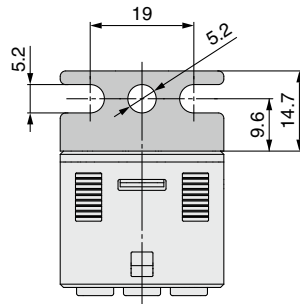
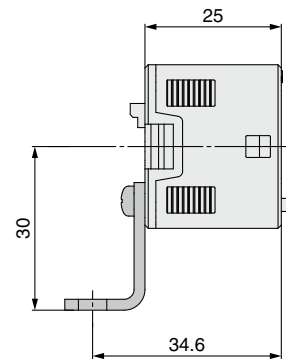
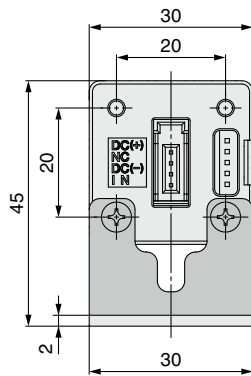

* Bracket configuration allows for mounting in four orientations.

Bracket B
(Part no.: ZS-46-A2)

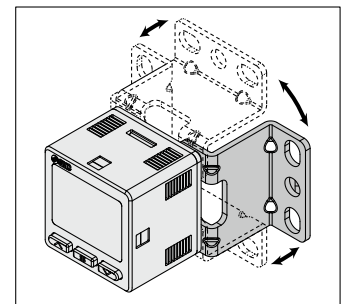
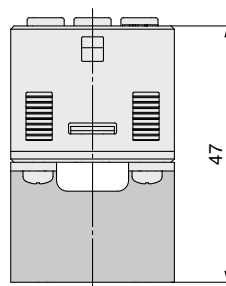

* Bracket configuration allows for mounting in four orientations.

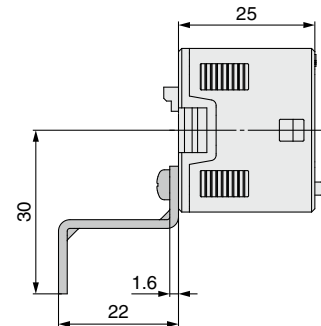
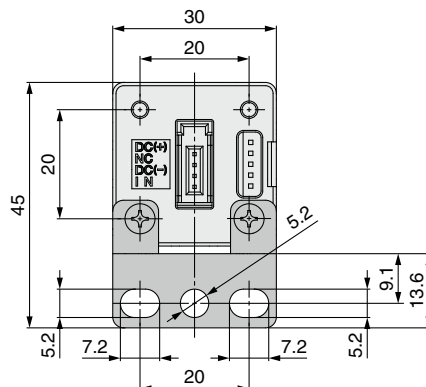

PFG300 Series

Dimensions

Panel mount adapter (Part no.: ZS-46-B)

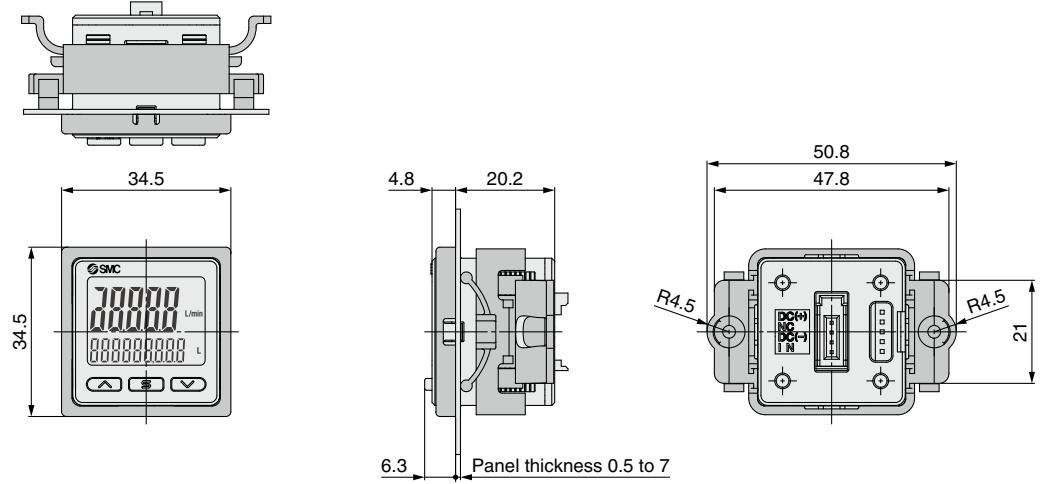

Panel mount adapter + Front protection cover (Part no.: ZS-46-D)

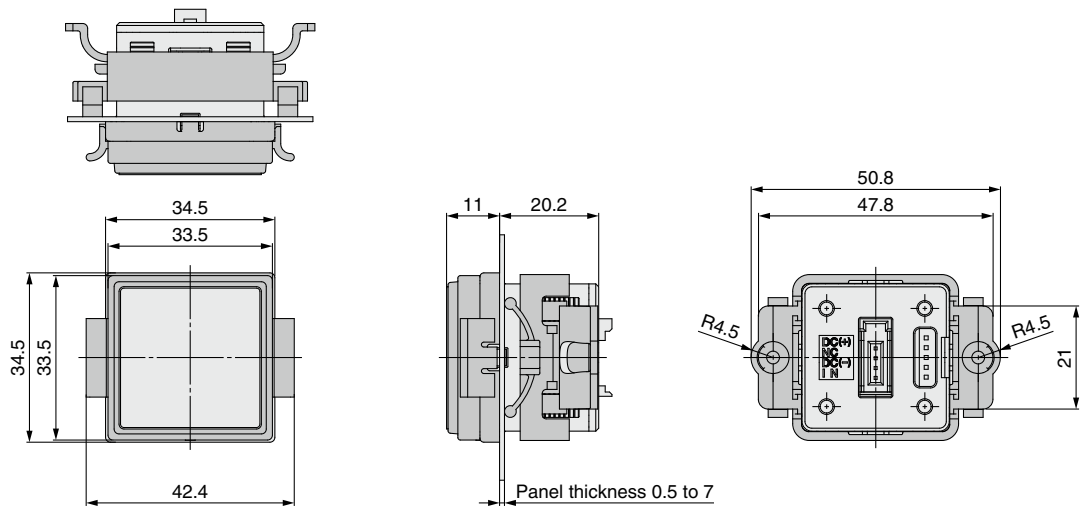

Power supply/output connection lead wire (Part no.: ZS-46-5L)

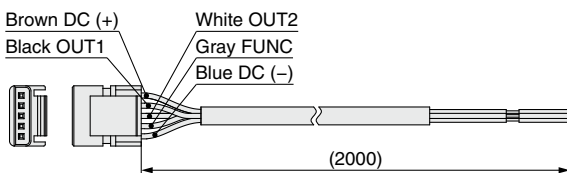

Sensor connector (Part no.: ZS-28-CA-4)

Pin no.	Terminal
1	DC (+)
2	N.C.
3	DC (-)
4	IN*1

*1 1 to 5 V or 4 to 20 mA

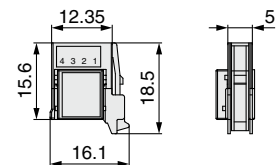

Cable Specifications

Conductor cross section	0.15 mm ² (AWG26)	
Insulator	Outside diameter	1.0 mm
	Color	Brown, Blue, Black, White, Gray (5-core)
Sheath	Finished outside diameter	ø3.5

Dimensions

Panel fitting dimensions

Individual mounting

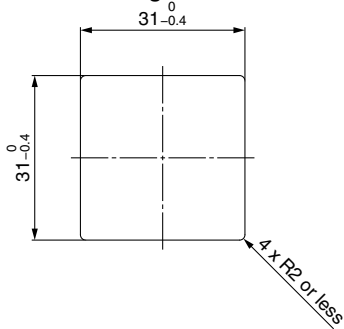

Multiple (2 pcs. or more) secure mounting <Horizontal>

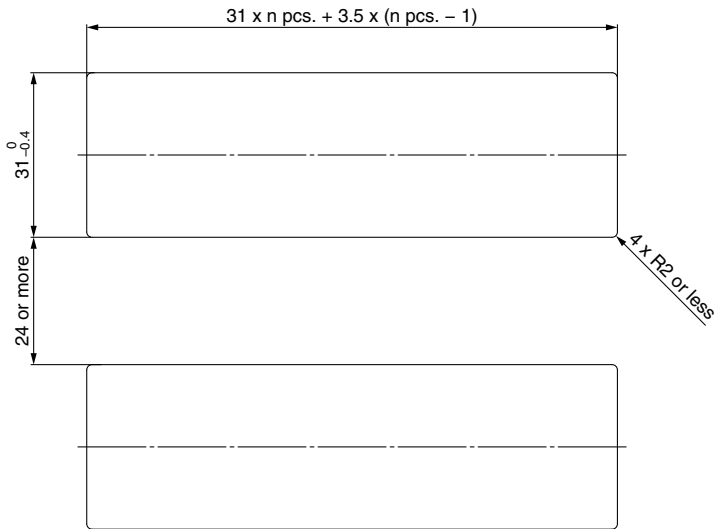

<Vertical>

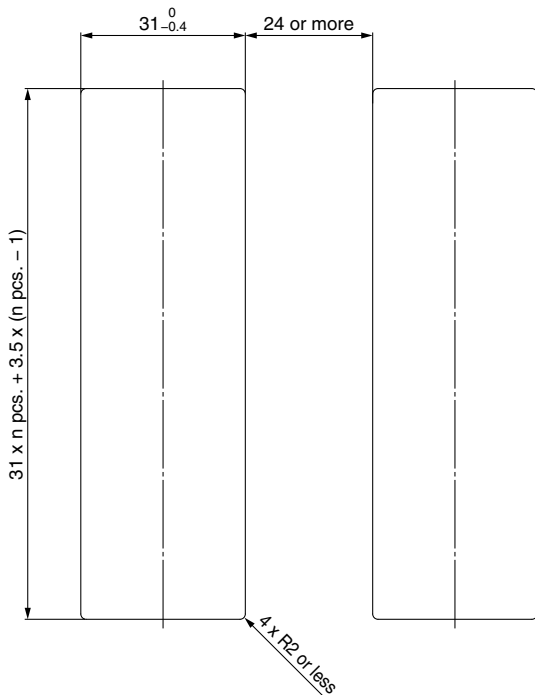

Panel mount example <Horizontal>

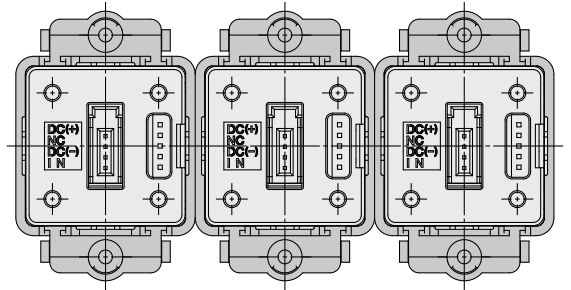

Panel mount example <Vertical>

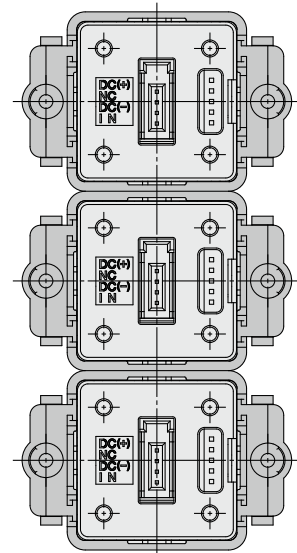

Body Ported Type PFG3A□H(-L)

Modular Type PFG3A□H(-L)

PFG300

Function Details

PF3A□H(-L) Series Function Details

* The pressure and temperature settings are only available for the PF3A8□H-L series.

For the setting of functions and operation methods, refer to the "Operation Manual" on the SMC website.

Output operation

The output operation can be selected from the following:
Output (hysteresis mode and window comparator mode) corresponding to instantaneous flow, pressure, and temperature, or output (accumulated output and pulse output) corresponding to accumulated flow
(Default setting: Hysteresis mode, Normal output)

Simple setting mode

Only the set values for instantaneous flow, accumulated flow, pressure, and temperature can be changed. The output mode, output type, display color, and accumulated pulse output cannot be changed.

Display color

The display color can be selected for each output status. The selection of the display color provides visual identification of abnormal values.

Green for ON, Red for OFF
Red for ON, Green for OFF
Red all the time
Green all the time

Reference condition

The display unit can be selected from standard conditions or normal conditions.

Standard conditions: Flow rate converted to a volume at 20°C and 101.3 kPa (absolute pressure)
Normal conditions: Flow rate converted to a volume at 0°C and 101.3 kPa (absolute pressure)

Response time (Digital filter)

The response time (digital filter) can be set to suit the application.

(Default setting: Flow rate: 1 s, Pressure: 0.1 s)

The effects of fluctuation and the flickering of the display can be reduced by changing the response time (digital filter).

Flow rate	Pressure	Temp.
1 s	0 to 30 s	1 s
2 s	(Increments of	
5 s	0.01 s)	

FUNC output switching function

Analog output or external input can be selected. (Default setting: Analog output)

Selectable analog output function

1 to 5 V or 0 to 10 V can be selected for the analog voltage output type. (Default setting: 1 to 5 V)

External input function

The accumulated flow, peak value, and bottom value can be reset remotely.

Accumulated value external reset: The accumulated flow value is reset via external input signal.

In accumulated increment mode, the accumulated value will reset to and increase from zero.

In accumulated decrement mode, the accumulated value will reset to and decrease from the set value.

* When the accumulated value is stored to memory, every time the accumulated value external reset is activated, the memory will be accessed. Take into consideration that the max. number of times the memory can be accessed is 1.5 million times. The total number of external inputs and the accumulated value memorizing time interval should not exceed 1.5 million times.

Peak/Bottom value reset: The peak value and bottom value are reset.

Forced output function

The output is forced ON/OFF when starting the system or during maintenance. This enables confirmation of the wiring and prevents system errors due to unexpected output.

For the analog output type: When ON, the output will be 5 V or 20 mA, and when OFF, 1 V or 4 mA.

For the IO-Link compatible PF3A□H-L series, diagnostic bit (error and flow rate) and process data (PD) flow measurement can be checked.

* Also, the increase or decrease of the flow will not change the ON/OFF status of the output while the forced output function is activated.

Accumulated value hold

The accumulated value is not cleared even when the power supply is turned OFF. The accumulated value is memorized every 2 or 5 minutes during measurement and continues from the last memorized value when the power supply is turned ON again.

The max. writable limit of the memory device is 1.5 million times, which should be taken into consideration.

Peak/Bottom value display

The max. (min.) flow rate is detected and updated from when the power supply is turned ON. In peak (bottom) value display mode, this max. (min.) flow rate as well as the pressure and temperature are displayed.

Display OFF mode

This function will turn the display OFF.

In the display OFF mode, three digits " _ _ _ " on the right side of the sub display will flash.

If any button is pressed during this mode, the display reverts to normal for 30 seconds to allow the flow, pressure, temperature, etc., to be quickly checked.

When a flow monitor (PFG300 series) is connected, the displayed values might be different due to an error. When a flow monitor display is to be used, it is recommended that this product be set to the display OFF mode.

Setting of a security code

The user can select whether a security code must be entered to release the key lock. At the time of shipment from the factory, it is set such that a security code is not required.

Key-lock function

Prevents operation errors such as accidentally changing setting values

Reset to the default settings

The product can be returned to its factory default settings.

Reversible display mode

When the switch is used upside down, the orientation of the display can be rotated to make it easier to read by using the reversible display function.



When the display is upside down

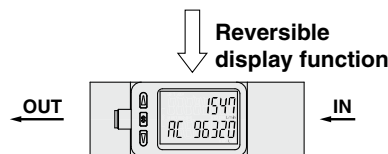

Zero cut-off function

When the flow is close to 0 L/min, the product will round the value down and zero will be displayed. A flow value may be displayed even when the flow rate is 0 L/min due to high pressure or depending on the installation. The zero cut-off function will force the display to zero. The range to display zero can be changed. (For the PF3A8□H-L series, the pressure is also subject to this function.)

Example) Vertical mounting, Fluid direction: Bottom to top

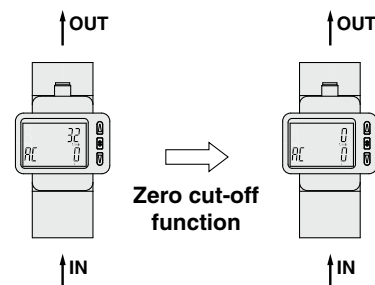

Delay time setting

(PF3A□H-L series only)

The time from when the instantaneous flow, pressure, and temperature reach the set values to when the switch output operates can be set. Setting the delay time can prevent the switch output from chattering.







The total switching time is the switch operation time and the set delay time.

(Default setting: 0 s)

0 to 60 s (Increments of 0.01 s)

■ Selection of the display on the sub screen

The display on the sub screen in measuring mode can be set.

 <p>Sub screen</p>	Accumulated value display Displays the accumulated value 	Set value display Displays the set value 	Peak value display Displays the peak value 
	Switch output/Communication mode display Displays the current mode (Only for the IO-Link compatible products) 	Bottom value display Displays the bottom value 	Line name display Displays the line name 

■ Analog output free range function

This function allows a flow that generates an output of 5 V (or 10 V when 0 to 10 V is selected) or 20 mA to be changed. The value can be changed between 10% of the max. value of the rated flow and the max. value of the display range.

For analog voltage output of 0 to 10 V

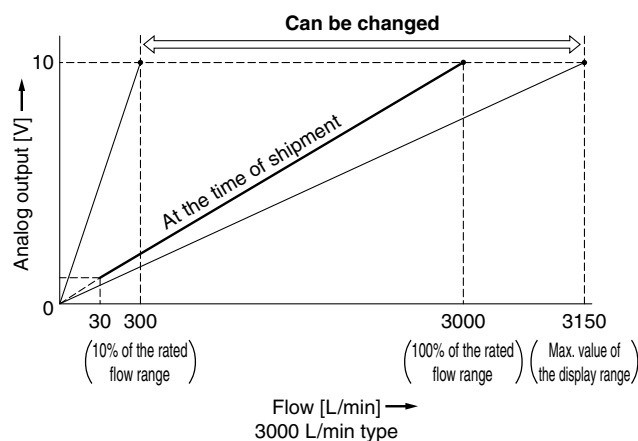
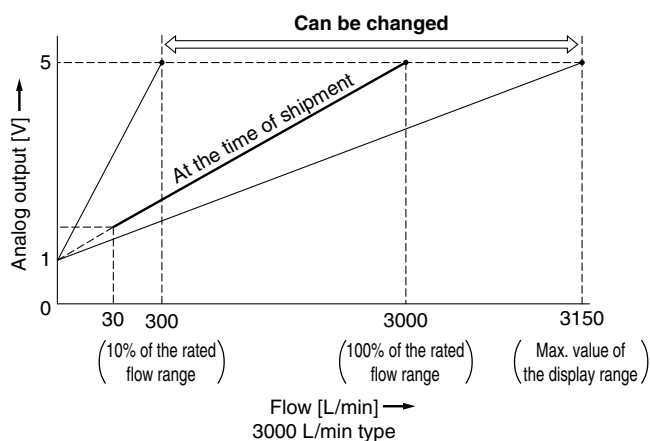

■ Error display function

When an error or abnormality arises, the location and contents are displayed.

Display	Error name	Description	Action
Er1	OUT over current error * Er2: PF3A8□-L series only	A load current of 80 mA or more has been applied to the switch output (OUT).	Eliminate the cause of the over current by turning OFF the power supply and then turning it ON again.
Er2			
HHH	Instantaneous flow error Pressure/Temperature error*1 *1 PF3A8□-L series only	The flow rate, pressure, or temperature exceeds the upper limit of the setting range.	Decrease the flow rate, pressure, or temperature.
LLL	Pressure/Temperature error * PF3A8□-L series only	The pressure or temperature exceeds the lower limit of the setting range.	Increase the pressure or temperature.
999999 (Flashing)	Accumulated flow error	The accumulated flow has exceeded the accumulated flow range. (For accumulated increment)	Reset the accumulated flow.
0 (Flashing)	Accumulated flow error	The accumulated flow has reached the set accumulated flow value. (For accumulated decrement)	
Er3	System error	An internal data error has occurred.	Turn the power OFF and then ON again.
Er0			
Er4			
Er5			
Er6			
Er7			
Er8			
Er10			
Er12			
Er14			
Er16			
Er40			
Er15	Version does not match * Only for the IO-Link compatible products	The IO-Link version does not match that of the master.	Ensure that the master IO-Link version matches the device version.

If the error cannot be solved after the instructions above are performed, please contact SMC for investigation.

PF3A□H(-L) Series

■ Zero-clear function (PF3A8□H-L series only)



This function clears and resets the zero value on the display of the measured pressure. The indicated value can be adjusted within $\pm 7\%$ F.S. of the pressure at the time of shipment from the factory.

■ Display fine adjustment function (PF3A8□H-L series only)

Fine adjustment of the indicated value of the pressure sensor can be made within the range of $\pm 5\%$ of the read value. (This eliminates wide variations of the indicated value.)

■ Measurement display setting (PF3A8□H-L series only)

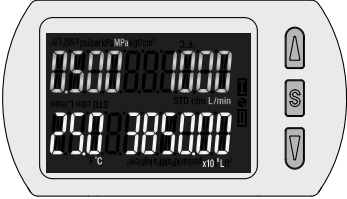
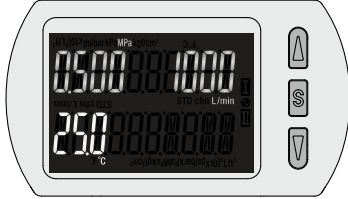
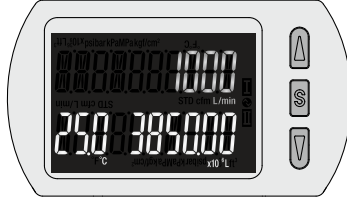
Display/hide the measured accumulated flow rate, pressure, and temperature.

Normal display	Accumulated flow display OFF	Pressure display OFF
<p>Displays the instantaneous flow, accumulated flow, pressure, and temperature</p> 	<p>Displays items other than the accumulated flow</p> 	<p>Displays items other than the pressure</p> 
Temperature display OFF	Accumulated flow, pressure, and temperature display OFF	
<p>Displays items other than the temperature The accumulated flow display changes from 6 digits to 9 digits.</p> 	<p>Displays the instantaneous flow</p> 	

PFG300 Series

Function Details

For the setting of functions and operation methods, refer to the "Operation Manual" on the SMC website.

Output operation

The output operation can be selected from the following:
Output (hysteresis mode and window comparator mode) corresponding to instantaneous flow or output (accumulated output and pulse output) corresponding to accumulated flow

(Default setting: Hysteresis mode, Normal output)

Simple setting mode

Only the set values for instantaneous flow and accumulated flow can be changed. The output mode, output type, display color, and accumulated pulse output cannot be changed.

Display color

The display color can be selected for each output status. The selection of the display color provides visual identification of abnormal values.

Green for ON, Red for OFF
Red for ON, Green for OFF
Red all the time
Green all the time

Delay time setting

The time from when the instantaneous flow reaches the set value to when the switch output operates can be set. Setting the delay time can prevent the switch output from chattering.

(Default setting: 0 s)

0.00 s
0.05 to 0.1 s (Increments of 0.01 s)
0.1 to 1.0 s (Increments of 0.1 s)
1 to 10 s (Increments of 1 s)
20 s
30 s
40 s
50 s
60 s

Digital filter setting

The time for the digital filter can be set to the sensor input. Setting the digital filter can reduce chattering of the switch output and flickering of the analog output and the display.

The response time indicates when the set value is 90% in relation to the step input.

(Default setting: 0 s)

0.00 s
0.05 to 0.1 s (Increments of 0.01 s)
0.1 to 1.0 s (Increments of 0.1 s)
1 to 10 s (Increments of 1 s)
20 s
30 s

FUNC output switching function

Analog output, external input, or copy function can be selected.
(Default setting: Analog output)

Selectable analog output function

1 to 5 V or 0 to 10 V can be selected for the analog voltage output type.
(Default setting: 1 to 5 V)

External input function

The accumulated flow, peak value, and bottom value can be reset remotely.

Accumulated value external reset: The accumulated flow value is reset via external input signal.

In accumulated increment mode, the accumulated value will reset to and increase from zero.

In accumulated decrement mode, the accumulated value will reset to and decrease from the set value.

* When the accumulated value is stored to memory, every time the accumulated value external reset is activated, the memory will be accessed. Take into consideration that the max. number of times the memory can be accessed is 1.5 million times. The total number of external inputs and the accumulated value memorizing time interval should not exceed 1.5 million times.

Peak/Bottom value reset: The peak value and bottom value are reset.

Forced output function

The output is forced ON/OFF when starting the system or during maintenance. This enables confirmation of the wiring and prevents system errors due to unexpected output.

For the analog output type: When ON, the output will be 5 V (or 10 V when 0 to 10 V is selected) or 20 mA, and when OFF, 1 V (or 0 V when 0 to 10 V is selected) or 4 mA.

* Also, the increase or decrease of the flow will not change the ON/OFF status of the output while the forced output function is activated.

Accumulated value hold

The accumulated value is not cleared even when the power supply is turned OFF. The accumulated value is memorized every 2 or 5 minutes during measurement and continues from the last memorized value when the power supply is turned ON again.

The max. writable limit of the memory device is 1.5 million times, which should be taken into consideration.

Peak/Bottom value display

The max. (min.) flow rate is detected and updated from when the power supply is turned ON. In peak (bottom) value display mode, this max. (min.) flow rate is displayed.

Setting of a security code

The user can select whether a security code must be entered to release the key lock. At the time of shipment from the factory, it is set such that a security code is not required.

Key-lock function

Prevents operation errors such as accidentally changing setting values

Reset to the default settings

The product can be returned to its factory default settings.

Display with zero cut-off setting

When the flow is close to 0 L/min, the product will round the value down and zero will be displayed. A flow value may be displayed even when the flow rate is 0 L/min due to high pressure or depending on the installation. The zero cut-off function will force the display to zero. The range to display zero can be changed.

Body Ported Type PFG300H(-L)

Modular Type PFG300H(-L)

PFG300

Function Details

PF300 Series

■ Selection of the display on the sub screen

The display on the sub screen in measuring mode can be set.

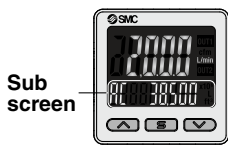

Set value display	Accumulated value display	Peak value display
Displays the set value 	Displays the accumulated value 	Displays the peak value
Bottom value display	Line name display	OFF
Displays the bottom value 	Displays the line name (Up to 5 alphanumeric characters can be input.) 	Displays nothing

■ Analog output free range function

This function allows a flow that generates an output of 5 V (or 10 V when 0 to 10 V is selected) or 20 mA to be changed. The value can be changed between 10% of the max. value of the rated flow and the max. value of the display range.

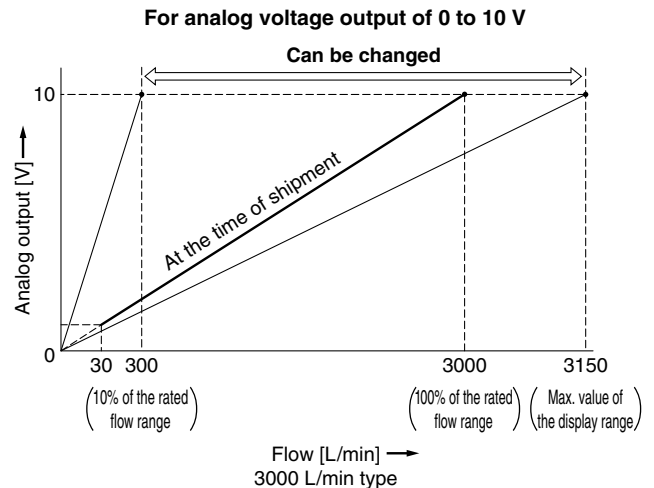
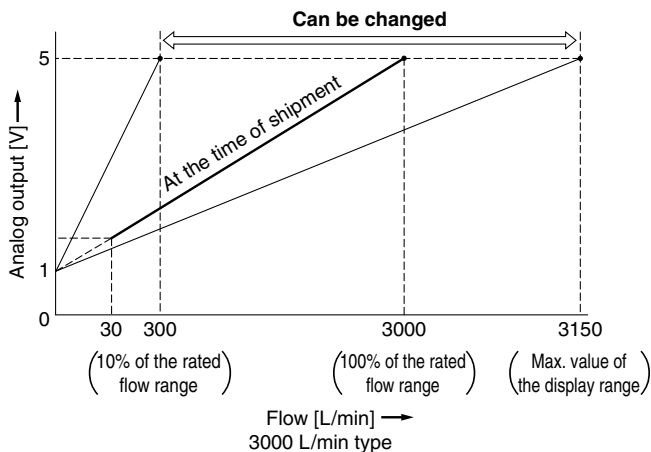

■ Error display function

When an error or abnormality arises, the location and contents are displayed.

Display	Error name	Description	Action
Er1 Er2	OUT over current error	A load current of 80 mA or more has been applied to the switch output (OUT).	Eliminate the cause of the over current by turning OFF the power supply and then turning it ON again.
HHH	Instantaneous flow error	The flow rate exceeds the max. value of the display range.	Decrease the flow rate.
LLL	Reverse flow error	There is a reverse flow equivalent to -5% or more. (Except PF3A7□H series)	Change the flow to the correct direction.
999999 flashes x 10 ⁶	Accumulated flow error	The flow rate exceeds the accumulated flow rate range.	Clear the accumulated flow rate.
Er0 Er4 Er6 Er7 Er8 Er14 Er40	System error	An internal data error has occurred.	Turn the power OFF and then ON again.
Er13	Copy error	The copy function does not operate properly.	After clearing the error by pressing the and buttons simultaneously for a minimum of 1 second, check the wiring and the model, and then attempt to copy again.

If the error cannot be solved after the instructions above are performed, please contact SMC for investigation.

■ **Copy function**

The settings of the master monitor can be copied to the slave monitors, reducing setting labor and minimizing the risk of setting mistakes.

The set value can be copied to up to 10 flow monitors simultaneously.
(Maximum transmission distance: 4 m)

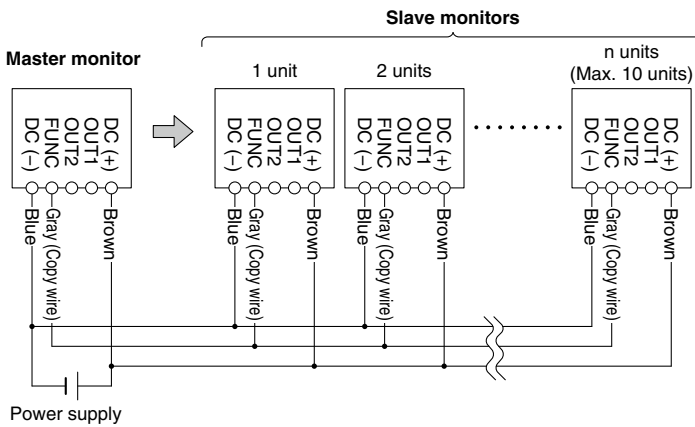
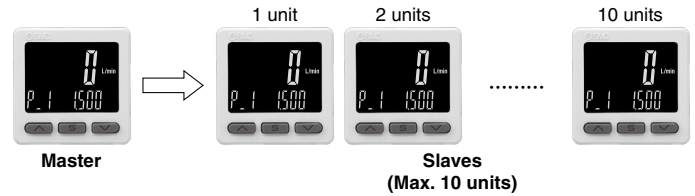

- 1) Wire as shown in the figure on the left.
- 2) Select the slave monitor which is to be the master, and change it into a master using the buttons. (In the default setting, all flow monitors are set as slaves.)
- 3) Press the **S** button on the master monitor to start copying.

■ **Selection of power saving mode**

The power saving mode can be selected.

With this function, if no buttons are pressed for 30 s, it shifts to power saving mode.

At the time of shipment from the factory, the product is set to the normal mode (the power saving mode is turned off).

(During power saving mode, [ECo] will flash in the sub screen and the operation light will be ON (only when the switch is ON).)

* There may be a difference in the displayed value on the connected flow switch and the flow monitor. When the flow monitor display is being used, it is recommended to set the flow switch display to OFF mode.

Body Ported Type **PF3A□H(-L)**

Modular Type **PF3A□H(-L)**

PFG300

Function Details

Safety Instructions

These safety instructions are intended to prevent hazardous situations and/or equipment damage. These instructions indicate the level of potential hazard with the labels of “**Caution**,” “**Warning**” or “**Danger**.” They are all important notes for safety and must be followed in addition to International Standards (ISO/IEC)*1), and other safety regulations.

 **Caution:** **Caution** indicates a hazard with a low level of risk which, if not avoided, could result in minor or moderate injury.

 **Warning:** **Warning** indicates a hazard with a medium level of risk which, if not avoided, could result in death or serious injury.

 **Danger :** **Danger** indicates a hazard with a high level of risk which, if not avoided, will result in death or serious injury.

*1) ISO 4414: Pneumatic fluid power – General rules relating to systems.
ISO 4413: Hydraulic fluid power – General rules relating to systems.
IEC 60204-1: Safety of machinery – Electrical equipment of machines.
(Part 1: General requirements)
ISO 10218-1: Manipulating industrial robots – Safety.
etc.

Warning

1. The compatibility of the product is the responsibility of the person who designs the equipment or decides its specifications.

Since the product specified here is used under various operating conditions, its compatibility with specific equipment must be decided by the person who designs the equipment or decides its specifications based on necessary analysis and test results. The expected performance and safety assurance of the equipment will be the responsibility of the person who has determined its compatibility with the product. This person should also continuously review all specifications of the product referring to its latest catalog information, with a view to giving due consideration to any possibility of equipment failure when configuring the equipment.

2. Only personnel with appropriate training should operate machinery and equipment.

The product specified here may become unsafe if handled incorrectly. The assembly, operation and maintenance of machines or equipment including our products must be performed by an operator who is appropriately trained and experienced.

3. Do not service or attempt to remove product and machinery/equipment until safety is confirmed.

1. The inspection and maintenance of machinery/equipment should only be performed after measures to prevent falling or runaway of the driven objects have been confirmed.
2. When the product is to be removed, confirm that the safety measures as mentioned above are implemented and the power from any appropriate source is cut, and read and understand the specific product precautions of all relevant products carefully.
3. Before machinery/equipment is restarted, take measures to prevent unexpected operation and malfunction.

4. Contact SMC beforehand and take special consideration of safety measures if the product is to be used in any of the following conditions.

1. Conditions and environments outside of the given specifications, or use outdoors or in a place exposed to direct sunlight.
2. Installation on equipment in conjunction with atomic energy, railways, air navigation, space, shipping, vehicles, military, medical treatment, combustion and recreation, or equipment in contact with food and beverages, emergency stop circuits, clutch and brake circuits in press applications, safety equipment or other applications unsuitable for the standard specifications described in the product catalog.
3. An application which could have negative effects on people, property, or animals requiring special safety analysis.
4. Use in an interlock circuit, which requires the provision of double interlock for possible failure by using a mechanical protective function, and periodical checks to confirm proper operation.

Caution

1. The product is provided for use in manufacturing industries.

The product herein described is basically provided for peaceful use in manufacturing industries.
If considering using the product in other industries, consult SMC beforehand and exchange specifications or a contract if necessary.
If anything is unclear, contact your nearest sales branch.

Limited warranty and Disclaimer/ Compliance Requirements

The product used is subject to the following “Limited warranty and Disclaimer” and “Compliance Requirements”.

Read and accept them before using the product.

Limited warranty and Disclaimer

1. The warranty period of the product is 1 year in service or 1.5 years after the product is delivered, whichever is first.*2)
Also, the product may have specified durability, running distance or replacement parts. Please consult your nearest sales branch.
2. For any failure or damage reported within the warranty period which is clearly our responsibility, a replacement product or necessary parts will be provided.
This limited warranty applies only to our product independently, and not to any other damage incurred due to the failure of the product.
3. Prior to using SMC products, please read and understand the warranty terms and disclaimers noted in the specified catalog for the particular products.

*2) Vacuum pads are excluded from this 1 year warranty.

A vacuum pad is a consumable part, so it is warranted for a year after it is delivered.
Also, even within the warranty period, the wear of a product due to the use of the vacuum pad or failure due to the deterioration of rubber material are not covered by the limited warranty.

Compliance Requirements

1. The use of SMC products with production equipment for the manufacture of weapons of mass destruction (WMD) or any other weapon is strictly prohibited.
2. The exports of SMC products or technology from one country to another are governed by the relevant security laws and regulations of the countries involved in the transaction. Prior to the shipment of a SMC product to another country, assure that all local rules governing that export are known and followed.

Caution

SMC products are not intended for use as instruments for legal metrology.

Measurement instruments that SMC manufactures or sells have not been qualified by type approval tests relevant to the metrology (measurement) laws of each country. Therefore, SMC products cannot be used for business or certification ordained by the metrology (measurement) laws of each country.

Revision History

Edition B	* The digital flow monitor PFG300 series has been added. * Number of pages has been increased from 16 to 28.	VZ
Edition C	* IO-Link compatible products (PF3A7□H-L) have been added. * The modular type has been added. * Number of pages has been increased from 28 to 40.	YX
Edition D	* The 4-screen display PF3A8 series has been added. * Number of pages has been increased from 40 to 44.	ZU

Safety Instructions

Be sure to read the “Handling Precautions for SMC Products” (M-E03-3) and “Operation Manual” before use.