

# Gun Type Ionizer



## IZG10 Series



Lighting LED

Reduced operating force

Easy to hold grip

### Blow setting function

p. 179

Select from continuous blow or pulse blow.

### Trigger setting function

p. 179

Trigger linked/Trigger lock/OFF timer can be selected.

### Flow rate adjustment function

p. 180

Flow adjustment valve with indicator enables handheld flow adjustment.

Rapid static neutralization

0.3 s<sup>\*1</sup>

\*1 Distance: 150 mm,  
Operating pressure: 0.2 MPa

IZS40/41/42

IZT40/41(-L)/  
42(-L)/43(-L)

IZN10E

IZF

IZG10

ZVB

IZD10/IZE11

IZH10

Antistatic  
Equipment

# Blow and trigger setting can be selected.

## 1 Mode setting switch p. 187



Set no.	Blow setting	Trigger setting	
0	Continuous blow	Trigger linked	
1		Trigger lock	
2		OFF timer	3 s
3			5 s
4	7 s		
5	Pulse blow	Trigger linked	
6		Trigger lock	
7		OFF timer	3 s
8			5 s
9	7 s		

### Selection of blow setting

#### Continuous blow

Blows ionized air continuously.



#### Pulse blow

Pulse blow saves air.



### Selection of trigger setting

#### Trigger linked

Trigger ON/OFF and Blow ON/OFF are linked.

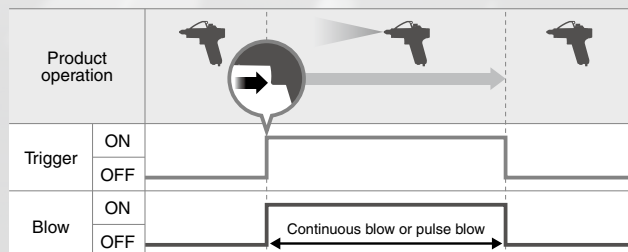

#### Trigger lock

Trigger operation turns Blow ON. Blow remains ON until another trigger input turns Blow OFF.

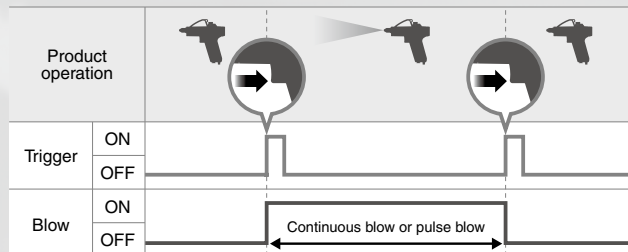

#### OFF timer

Trigger operation turns Blow ON. Blow remains ON for set time then automatically turns OFF.

Timer set time: 3 s, 5 s, 7 s

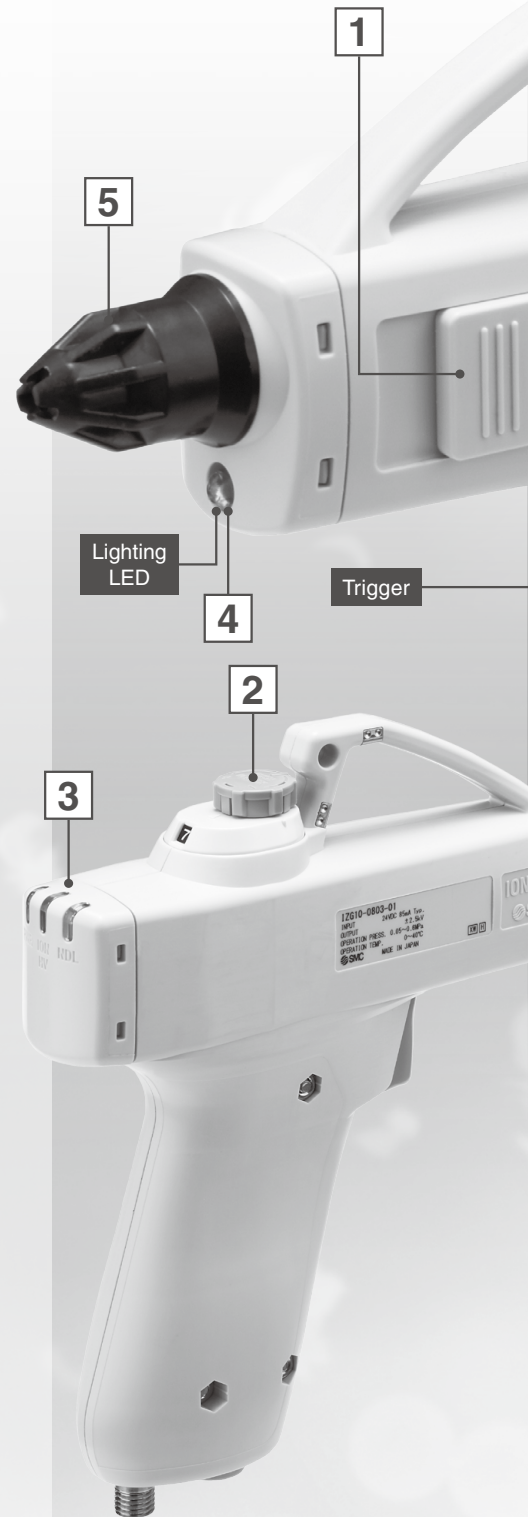
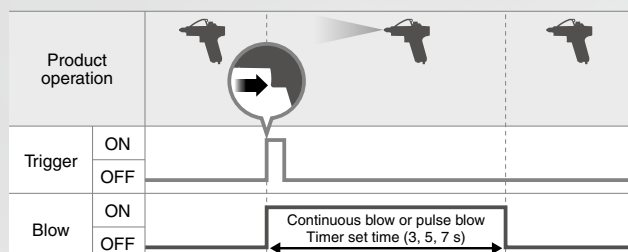



## 2 With flow adjustment valve (with indicator)



- Flow rate of ionized air can be adjusted on the gun.
- The flow rate can be controlled numerically.

Number of needle rotations	Flow rate [L/min (ANR)]
2	21
4	60
6	124
7	200

Supply pressure: 0.4 MPa

## 3 High visibility LEDs

Rear mounted LEDs are easy to see during operation.

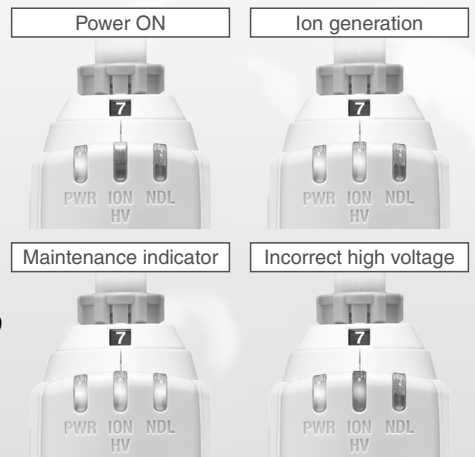

Turns ON when lowered static neutralization performance due to the contamination, wear, or breakage of the emitter is detected.

Turns ON when a high voltage output error, such as emitter short circuit or abnormal discharge occurs.

## 4 Lighting LED

Easy to find particles on the workpiece



## 5 Easy cleaning and replacement of emitters

### 1 Removal of nozzle

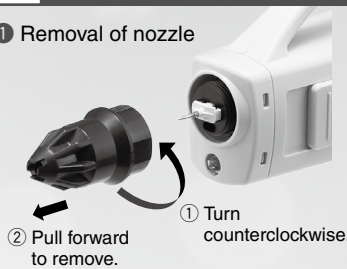

### 2 Removal of emitter

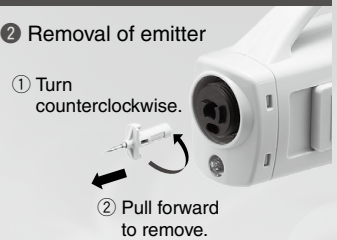

## 6 Bypass nozzle (Option)

OSHA1910.242b compliant

Even if the nozzle is obstructed, the main orifice pressure cannot exceed 30 psi (210 kPa).

\* Supply pressure: 0.5 MPa or less



IZS40/41/42

IZT40/41(-L)/42(-L)/43(-L)

IZN10E

IZF

IZG10

ZVB

IZD10/IZE11

IZH10

Antistatic Equipment

## Application Examples

For the static neutralization and dust removal of resin parts

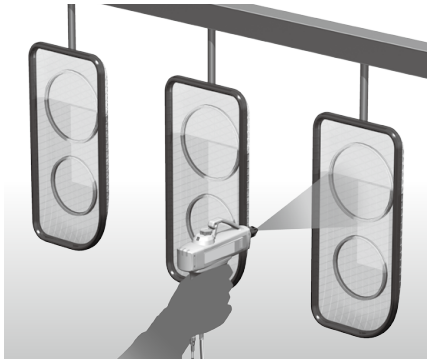

For the static neutralization and dust removal of resin parts

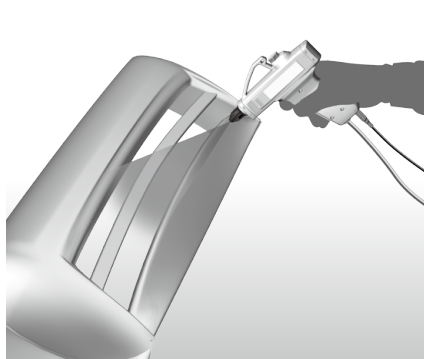

For the dust removal of resin products

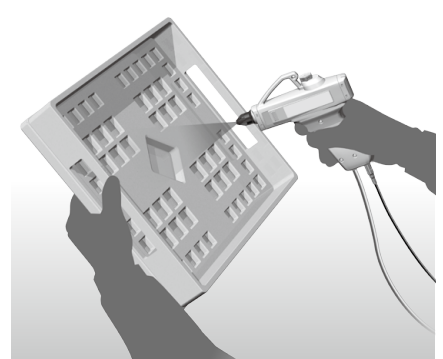

For the static neutralization and dust removal of electric substrates

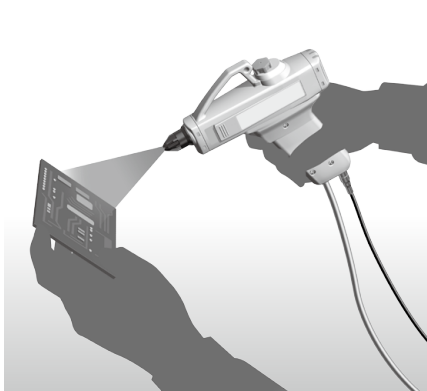

For the static neutralization and dust removal of resin parts with the ionizer suspended from above

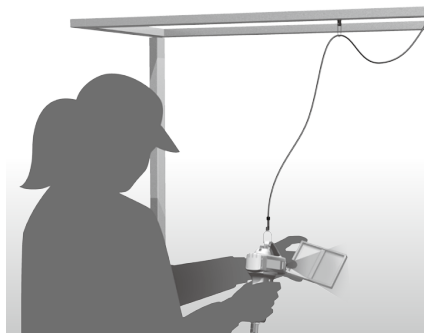

For the dust removal when detaching from film

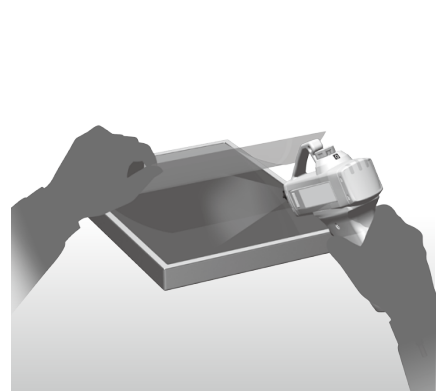

## CONTENTS

### Gun Type Ionizer *IZG10 Series*



#### Technical Data: Static Neutralization Characteristics

① Installation Distance and Discharge Time .....	p. 182
② Static Neutralization Range .....	p. 183
③ Pressure — Flow Rate Characteristics .....	p. 184
How to Order .....	p. 185
Accessories (for Individual Parts) .....	p. 185
Specifications .....	p. 186
AC Adapter Specifications .....	p. 186
Parts Description .....	p. 186

Description of LED Indicators .....	p. 186
Alarm .....	p. 186
Mode Switch Setting .....	p. 187
Wiring .....	p. 187
Dimensions .....	p. 188
Related Products .....	p. 189
Specific Product Precautions .....	p. 190

# IZG10 Series Technical Data

\* Static neutralization characteristics are based on data using a charged plate (Dimensions: 150 mm x 150 mm, Capacitance: 20 pF) as defined in the U.S. ANSI standards (ANSI/ESD STM3.1-2015). Use this data only as a guideline for model selection because the values vary depending on the material and/or size of the subject.

## Static Neutralization Characteristics

### ① Installation Distance and Discharge Time (Discharge Time from 1000 V to 100 V)

IZG10-□□-01/IZG10-□□-02

Mode setting switch: Continuous blow

#### 1) Number of needle rotations [2]

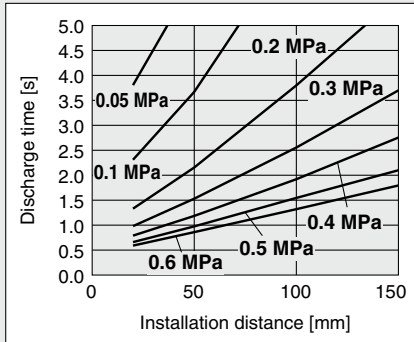

#### 2) Number of needle rotations [4]

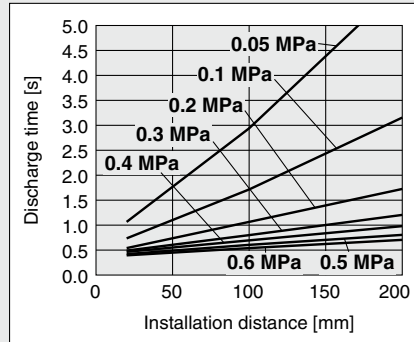

#### 3) Number of needle rotations [6]

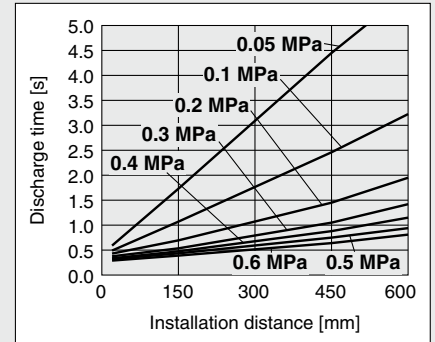

#### 4) Number of needle rotations [Max.]

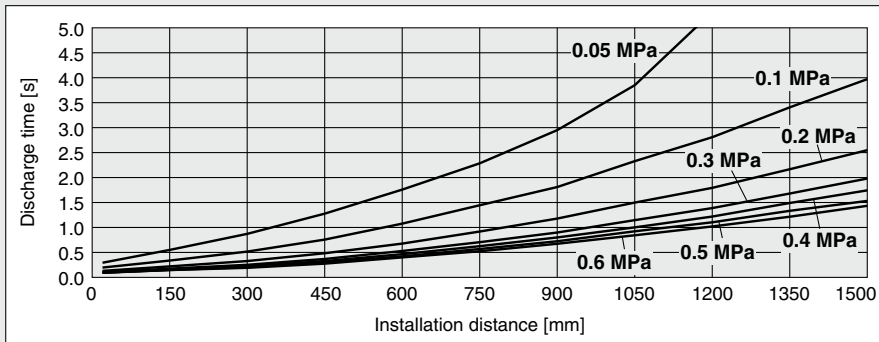

Mode setting switch: Pulse blow

#### 5) Number of needle rotations [2]

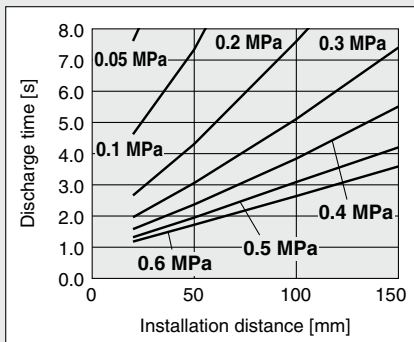

#### 6) Number of needle rotations [4]

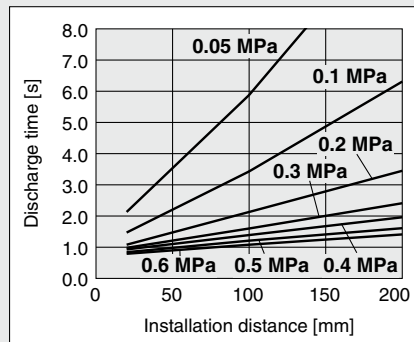

#### 7) Number of needle rotations [6]

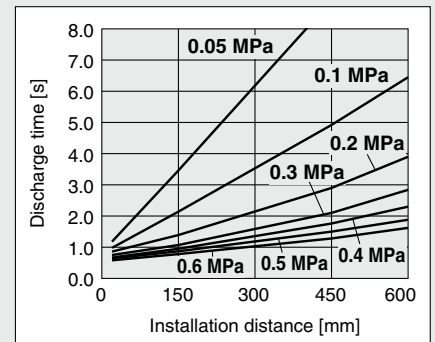

#### 8) Number of needle rotations [Max.]

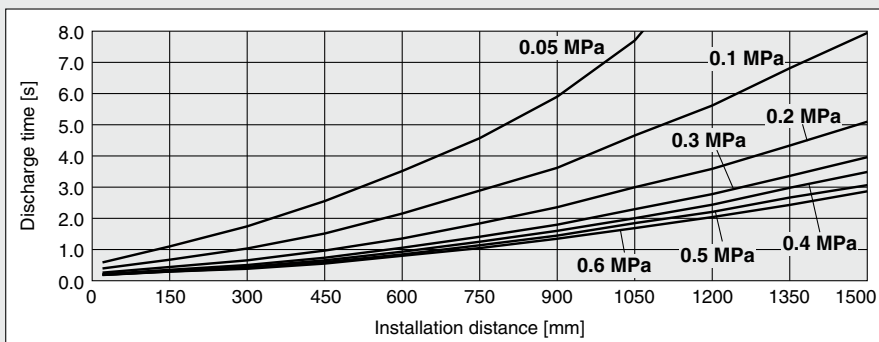

IZS40/41/42

IZT40/41(-L)/  
42(-L)/43(-L)

IZN10E

IZF

IZG10

ZVB

IZD10/IZE11

IZH10

Antistatic  
Equipment

\* Static neutralization characteristics are based on data using a charged plate (Dimensions: 150 mm x 150 mm, Capacitance: 20 pF) as defined in the U.S. ANSI standards (ANSI/ESD STM3.1-2015). Use this data only as a guideline for model selection because the values vary depending on the material and/or size of the subject.

## Static Neutralization Characteristics

### ② Static Neutralization Range (Discharge Time from 1000 V to 100 V)

#### IZG10-□□-01/IZG10-□□-02

Mode setting switch: Continuous blow, Number of needle rotations [Max.]

1) Supply pressure: 0.05 MPa Flow rate consumption: 80 L/min (ANR)

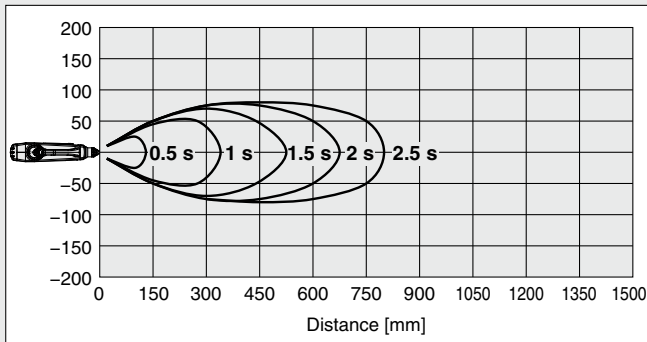

2) Supply pressure: 0.1 MPa Flow rate consumption: 119 L/min (ANR)

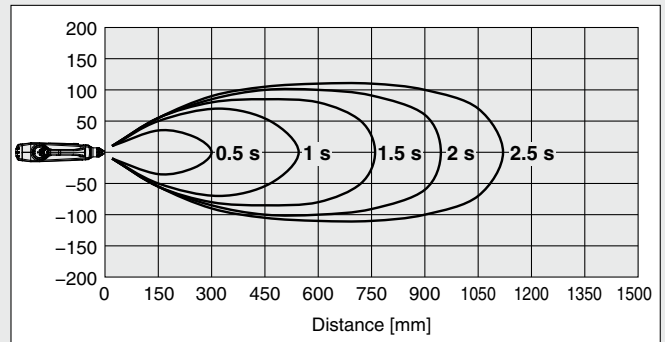

3) Supply pressure: 0.2 MPa Flow rate consumption: 188 L/min (ANR)

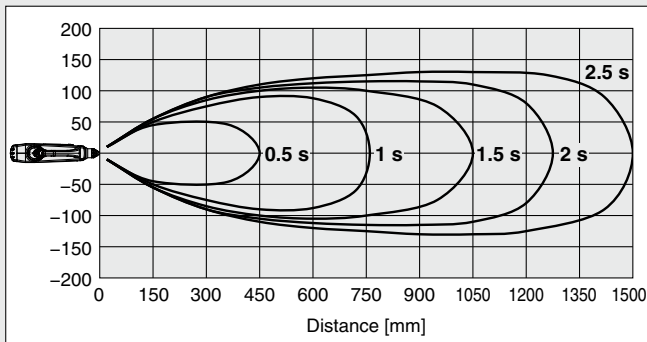

4) Supply pressure: 0.3 MPa Flow rate consumption: 253 L/min (ANR)

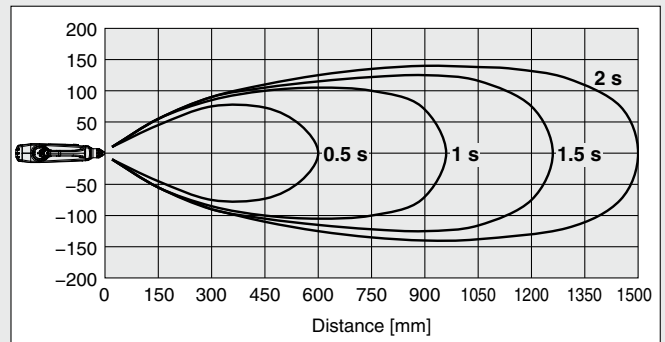

5) Supply pressure: 0.4 MPa Flow rate consumption: 316 L/min (ANR)

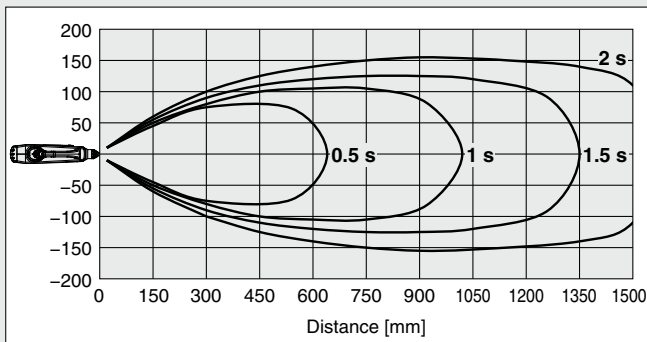

6) Supply pressure: 0.5 MPa Flow rate consumption: 390 L/min (ANR)

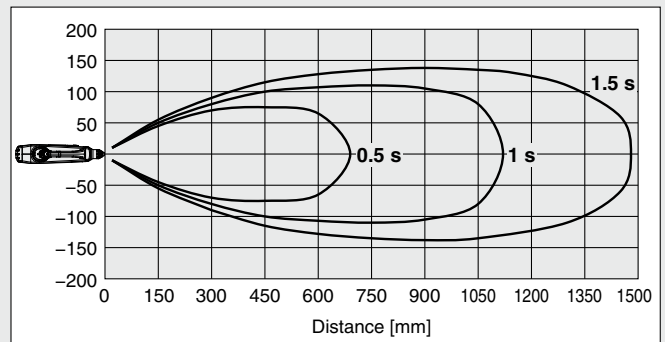

7) Supply pressure: 0.6 MPa Flow rate consumption: 450 L/min (ANR)

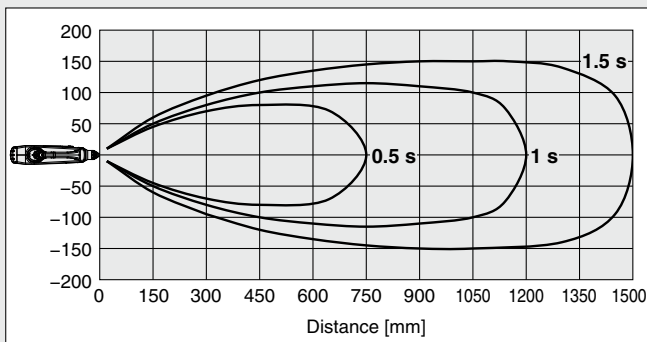

\* Static neutralization characteristics are based on data using a charged plate (Dimensions: 150 mm x 150 mm, Capacitance: 20 pF) as defined in the U.S. ANSI standards (ANSI/ESD STM3.1-2015). Use this data only as a guideline for model selection because the values vary depending on the material and/or size of the subject.

## Static Neutralization Characteristics

### ③ Pressure — Flow Rate Characteristics

**IZG10-□□-01/IZG10-□□-02**

Mode setting switch: Continuous blow

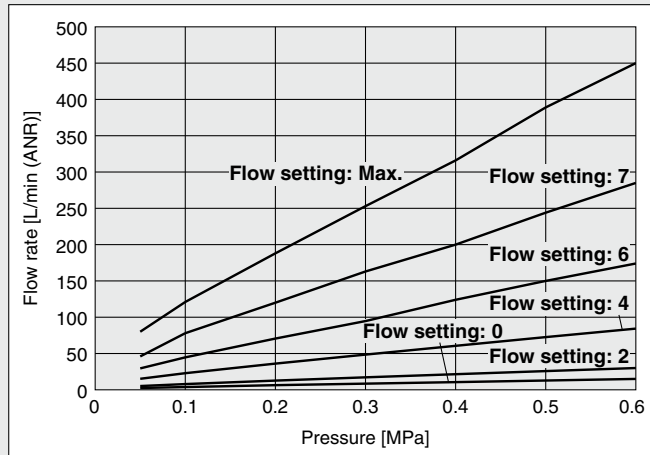

### How to measure

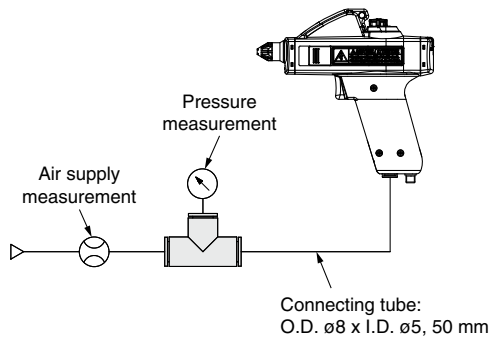

IZS40/41/42

IZT40/41(-L)/  
42(-L)/43(-L)

IZN10E

IZF

IZG10

ZVB

IZD10/IZE11

IZH10

Antistatic  
Equipment

# Gun Type Ionizer

# IZG10 Series

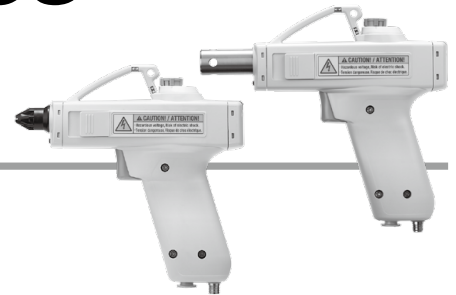

## How to Order

**IZG10-0801-01**

### One-touch fitting

Symbol	Port size
08	ø8 (Metric)
09	ø5/16" (Inch)

### AC adapter\*1, Power supply cable

Symbol	Type
01	AC adapter (With AC cord*2)
02	AC adapter (Without AC cord)
03	Power supply cable (For 24 VDC wiring)
N	None

### Nozzle type

Symbol	Type
01	Standard nozzle
02	Bypass nozzle*3

## Caution

The nozzle is specific for this product. Do not use any other nozzle. Doing so will adversely affect static neutralization performance.

- \*1 The AC adapter body and the power supply cable (For AC adapter) come as a set. Refer to the AC adapter image below under "Accessories."
- \*2 The AC cord has a rated voltage of 125 V. If using an input voltage exceeding 125 VAC, select "02" (Without AC cord) and prepare a suitable AC cord separately.
- \*3 This nozzle is compliant with the OSHA standard for hand and portable powered tools and equipment, general (1910.242b) requiring that "static pressure at the main orifice shall not exceed 30 psi (210 kPa). This requirement is necessary in order to prevent a back pressure buildup in case the nozzle is obstructed or dead ended." \* Supply pressure: 0.5 MPa or less OSHA: Occupational Safety and Health Administration

## Accessories (for Individual Parts)

### AC adapter

**IZG10-CG 1**

#### AC adapter\*1

Symbol	Type
1	With AC cord*2
2	Without AC cord



- \*1 The AC adapter body and the power supply cable (For AC adapter) come as a set.
- \*2 The AC cord has a rated voltage of 125 V. If using an input voltage exceeding 125 VAC, select "02" (Without AC cord) and prepare a suitable AC cord separately. The input (AC) side and output (DC) side of the AC adapter are not isolated. If using the AC adapter as DC power supply for a different product, this may cause an electric shock or malfunction. Do not use the AC adapter for the DC power supply of a different product.

### Power supply cable (For 24 VDC wiring)

**IZG10-CP**



Cable length: 3 m

### Nozzle assembly

**IZG10-A001-01**

#### Nozzle type

Symbol	Type
01	Standard nozzle
02	Bypass nozzle*1

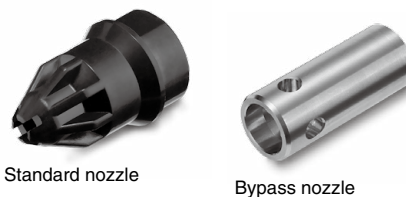

- \*1 This nozzle is compliant with the OSHA standard for hand and portable powered tools and equipment, general (1910.242b) requiring that "static pressure at the main orifice shall not exceed 30 psi (210 kPa). This requirement is necessary in order to prevent a back pressure buildup in case the nozzle is obstructed or dead ended." \* Supply pressure: 0.5 MPa or less OSHA: Occupational Safety and Health Administration

### Emitter assembly

**IZG10-NT**



- \* A protective cap is attached to the tip of the emitter when shipped. Please remove the cap before use.

### Cleaning kit

**IZS30-M2**

(With 1 felt pad, 1 rubber grindstone, and 2 replacement felt pads)

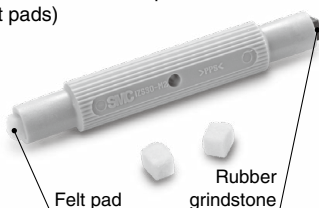

**IZS30-A0201**

(10 replacement felt pads)



**IZS30-A0202**

(1 replacement rubber grindstone)



### Removal tool

**IZG10-M1**

Use this tool to remove the emitter assembly. The removal tool is shipped together with the product. To order it separately, use the product number above. In addition, refer to the operation manual for replacement instructions.

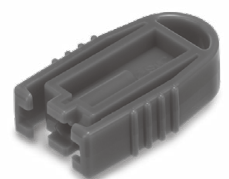



## Specifications

Ionizer model	<b>IZG10</b>	
Ion generation method	Corona discharge type	
Method of applying high voltage	High frequency AC type	
Applied voltage*1	±2.5 kV	
Offset voltage*2	Within ±10 V	
Air supply*3	Fluid	Air (Clean, dry air)
	Operating pressure	0.05 to 0.6 MPa
	Connecting tube size	ø8 (Metric), ø5/16" (Inch)
Power supply voltage	24 VDC ±10% (21.6 to 26.4 V)	
Current consumption	90 mA (typ.)	
Ambient temperature	0 to 40°C (No freezing)	
Ambient humidity	35 to 65%RH (No condensation)	
Material	Case: PBT Emitter: Tungsten	
Weight (Body only)	Standard nozzle	200 g
	Bypass nozzle	250 g
Standards/Directive	CE (EMC directive, RoHS directive), UKCA	

- \*1 Measured with a high pressure probe of 1000 MΩ and 5 pF
- \*2 Measurement value based on a charged plate (Dimensions: 150 mm x 150 mm, Capacitance: 20 pF) as defined in the U.S. ANSI standards (ANSI/ESD STM3.1-2015)  
When the distance between the charged plate and the ionizer is 150 mm, and the operating pressure is 0.2 MPa
- \*3 Static neutralization is not possible without supplying compressed air. Without compressed air, ozone or nitrogen oxides generated by the ion generation process may accumulate and adversely affect the product and peripheral equipment.

## AC Adapter Specifications

Input voltage*4	100 to 240 VAC 50/60 Hz
Output voltage	24 VDC ±5%
Output current	0.8 A max.
Ambient temperature	0 to 40°C
Ambient humidity	20 to 80%RH
Safety standards	IEC 62368-1

- \*4 An AC cord included with an AC adapter is only for use in Japan. (Rated voltage 125 V, Plug JIS C 8303, Inlet IEC 60320-C13)

## Parts Description

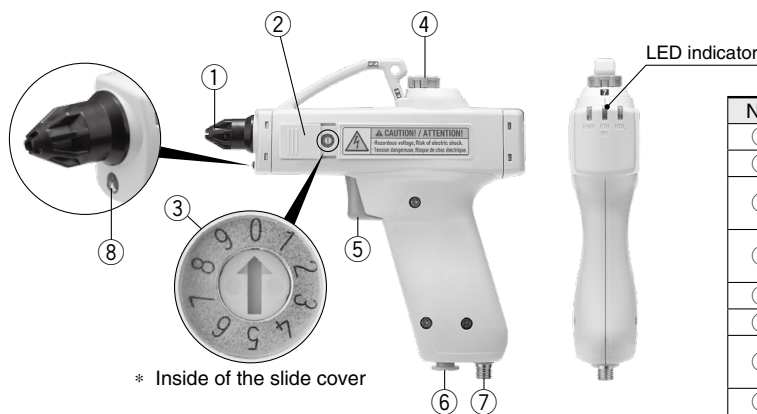

No.	Description	Contents
①	<b>Nozzle</b>	Discharge ionized air
②	<b>Slide cover</b>	Protective cover for the mode setting switch
③	<b>Mode setting switch</b>	Switch for setting blow and trigger (Default setting: Set no. 0)
④	<b>Flow adjustment knob (With indicator)</b>	Turn the knob to adjust the flow rate. Press the knob to lock the setting.
⑤	<b>Trigger</b>	Switch to turn on and off static neutralization
⑥	<b>One-touch fitting</b>	Supply port of compressed air
⑦	<b>Power supply connector</b>	Connector for power supply, F.G., and external switch inputs
⑧	<b>Lighting LED</b>	Illuminate the object during static neutralization

## Description of LED Indicators

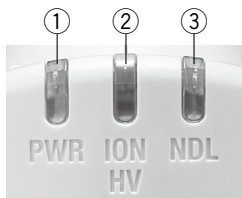

### LED Indicators

No.	Display	LED color	Description	Contents
①	PWR	Green	<b>Power supply indicator</b>	Green LED turns ON when power is supplied, and the LED flashes when the voltage is outside of the specification range.
②	ION/HV	Green/Red	<b>Static neutralization operation/incorrect high voltage indicator</b>	Green LED turns ON during static neutralization. Red LED turns ON when a high voltage abnormality is present.
③	NDL	Green	<b>Maintenance indicator</b>	Green LED turns ON when lowered static neutralization performance due to the contamination or wear of the emitter is detected.

## Alarm

The LEDs are used for notification of malfunctions. Please note that ion generation may either continue or stop depending on the type of abnormality.

Alarm name	Ion generation	LED			Description	Action to reset alarm
		PWR	ION/HV	NDL		
Power supply failure	Stop	Green (Flashing)	OFF	OFF	Connected power supply voltage is outside of specification.	Supply power again.
Incorrect high voltage	Stop	Green (ON)	Red (ON)	OFF	The high voltage output has dropped.	Supply power again.
CPU failure	Stop	Green (Flashing)	Red (Flashing)	Green (Flashing)	CPU error due to noise, etc.	Supply power again.
Maintenance indication	Continue	Green (ON)	—	Green (ON)	When static neutralization performance is reduced due to contamination, wear, or damage of the emitters	—

# IZG10 Series

## Mode Switch Setting

Blow or trigger setting can be selected by using the mode setting switch.

Open the slide cover and using a flat bladed screwdriver rotate the dial to select the setting number 0 to 9, referring to the table below.\*1  
Ensure the slide cover is closed when setting is complete.

\*1 Default setting: Set no. 0

**Table for Mode Setting Switch**

Set no.	Blow setting	Trigger setting	
0	Continuous blow	Trigger linked	
1		Trigger lock	
2		OFF timer	3 s
3			5 s
4	7 s		
5	Pulse blow	Trigger linked	
6		Trigger lock	
7		3 s	
8		5 s	
9		7 s	

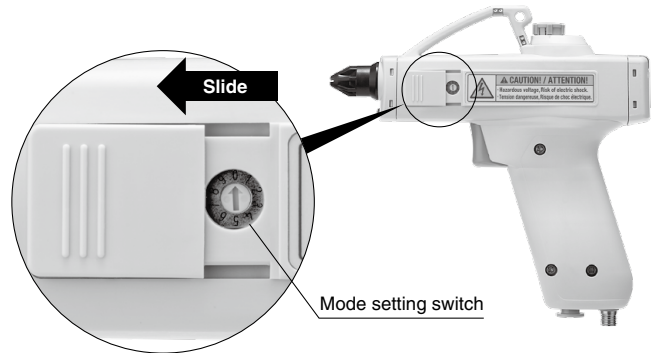

## Wiring

### AC adapter type IZG10-□01, 02

- Connect the M8 connector on the power cable for AC adapter to the power connector on the main unit. Connect the plug of the AC cord\*1 to a commercial power outlet with a ground terminal (100 to 240 VAC, 50/60 Hz).
- Ensure the ground terminal is correctly connected. The ground terminal is connected to the frame ground (F.G.) of this product. Static neutralization performance is achieved by using the F.G. connection to maintain the same electrical potential as the reference potential of the operating environment.
- The input ground terminal and the output DC (-) terminal of the AC adapter (IZG10-CG1, 2 ordered separately) are electrically connected. Do not connect any equipment other than this product. Otherwise, a failure or electric shock may result.

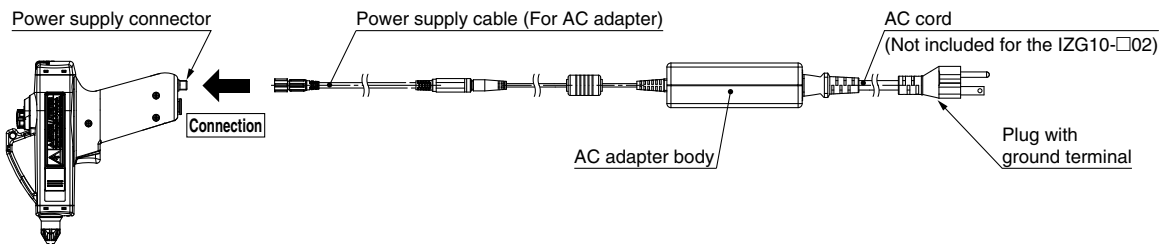

Ionizer body

AC adapter (With AC cord)

\*1 The rated voltage of the AC cable supplied with IZG10-□01 is 125 V, and the plug is JIS C 8303 type B for Japanese domestic use. If the product is used in an area with a higher voltage rating (220 or 240 VAC), select IZG10-□02 without AC power cable, and use an AC cable with an IEC 60320-C13 ground terminal connector, suitable for the power supply voltage.

### Power supply cable type IZG10-□03

- Connect the user equipment for the power supply and external switch input according to Power Supply Cable Wiring table.
- Ensure the green F.G. cable is correctly grounded. Static neutralization performance is achieved by maintaining the same electrical potential as the reference potential of the operating environment.

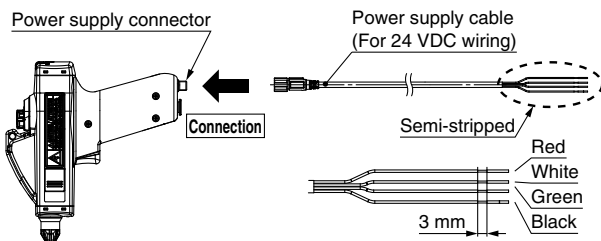

Ionizer body

Power supply cable (For 24 VDC wiring)

### Internal circuits and wiring example

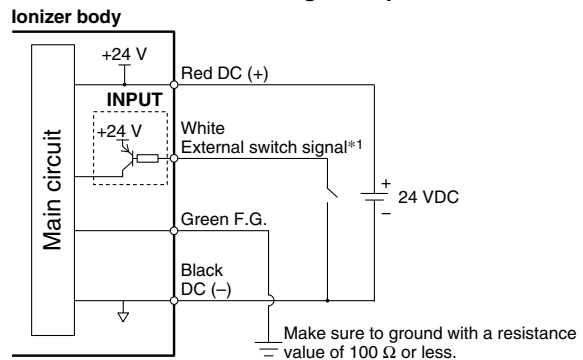

### Power Supply Cable Wiring

Identification color	Signal name	Description
Red	DC (+)	Connects to the power supply (+) terminal
White	External switch signal*1	Blow starts by connecting to DC (-).
Green	F.G.	Frame ground of the product: Make sure to ground with a resistance value of 100 Ω or less.
Black	DC (-)	Connects to the power supply (-) terminal

\*1 The external switch signal is used in an OR configuration with the trigger input. When the external switch signal is not used, cut back the semi-strip wire to prevent any contact with the conductor.

## Dimensions

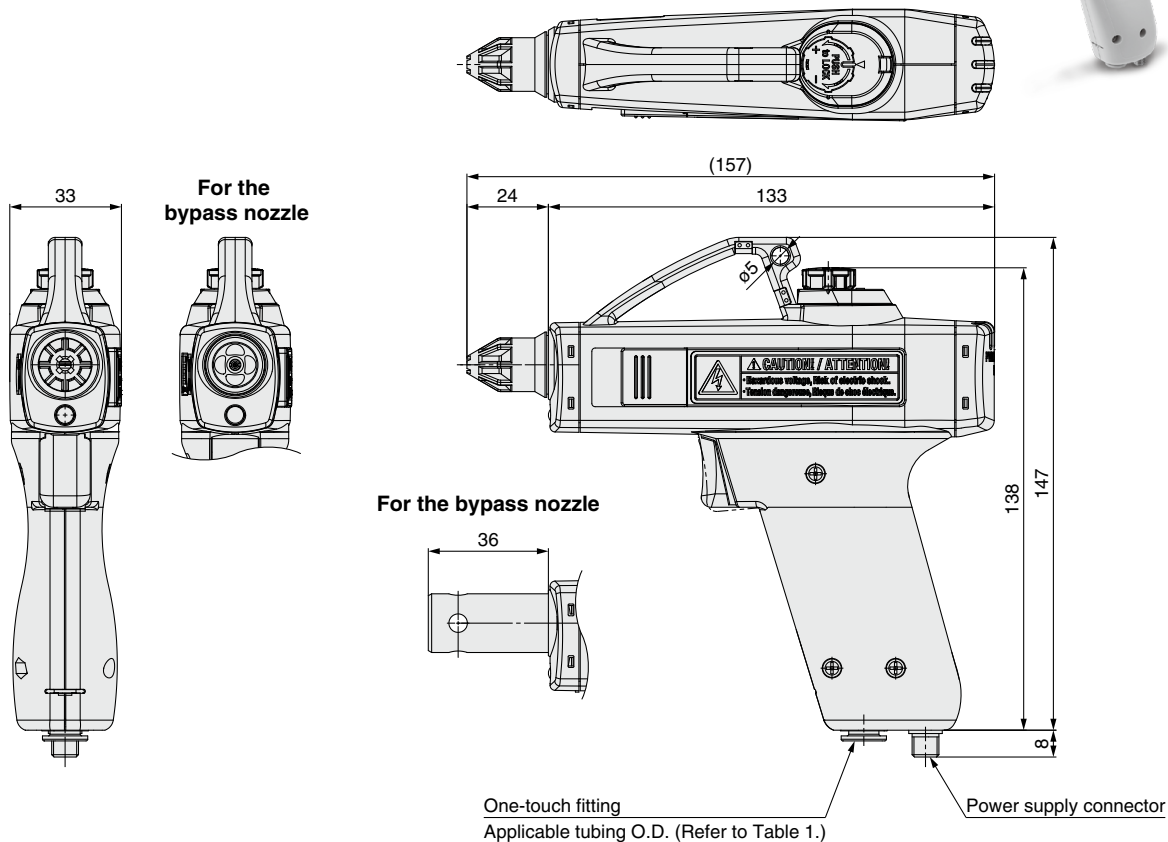

**Table 1**

Model	Applicable tubing O.D.
<b>IZG10-08□-01</b>	ø8 (Metric)
<b>IZG10-09□-01</b>	ø5/16" (Inch)

## AC adapter IZG10-CG□

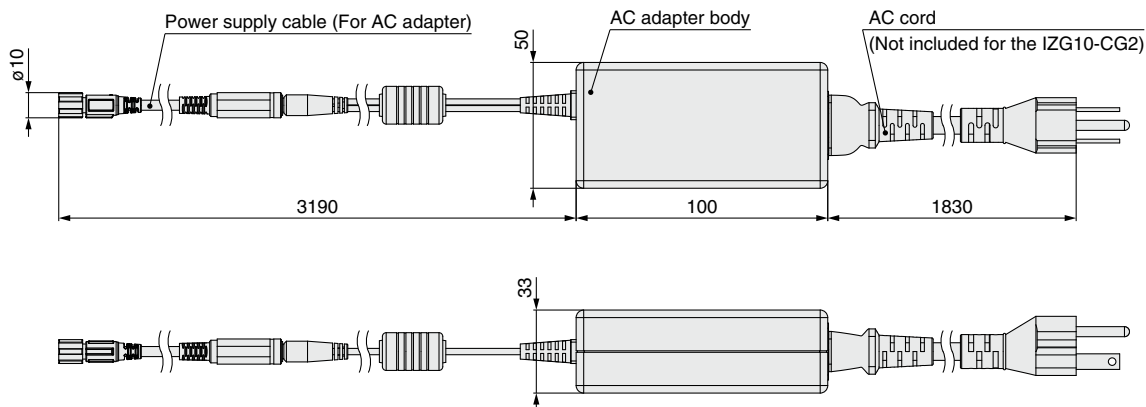

Model	AC cord
<b>IZG10-CG1</b>	Included
<b>IZG10-CG2</b>	None

## Power supply cable (For 24 VDC wiring) IZG10-CP

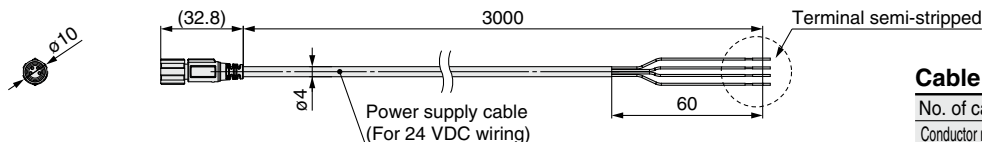

### Cable Specifications

No. of cable wires/Size	4 cores/AWG26
Conductor nominal cross section	0.15 mm <sup>2</sup>
Insulator O.D./identification color	0.85 mm/Red, Black, White, Green
Sheath material	Lead-free PVC
Outside diameter	4 mm

# IZG10 Series Related Products

## Recommended pneumatic circuit diagram

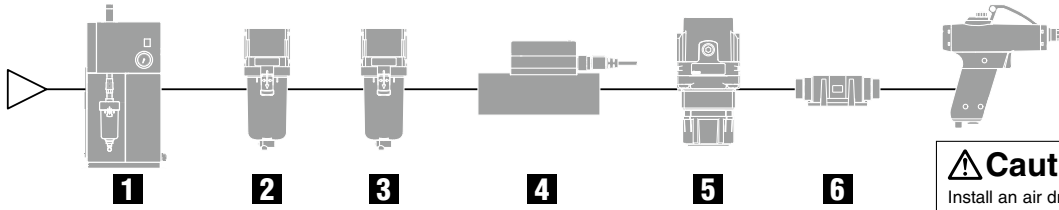

IZG10

### Caution

Install an air dryer, air filter, line filter, and/or mist separator to obtain clean compressed air (A compressed air quality of Class 2.4.3, 2.5.3, 2.6.3, or higher according to ISO 8573-1:2010 (JIS B 8392-1:2012) is recommended for operation.).

### 1 Air Dryer

Removes moisture in the compressed air

IDF Series



### 2 Air Filter, Line Filter

Eliminates solid foreign matter such as powder particles in the compressed air

AF Series

AFF Series



### 3 Mist Separator

Eliminates oil mist which is difficult to eliminate with an air filter

AFM Series

AM Series



### 4 3-Color Display Digital Flow Switch

Flow range: Max. 12000 L/min  
Flow ratio 100 : 1

PF3A7□H Series



### 2-Color Display Digital Flow Switch

Flow range: Max. 2000 L/min  
Flow ratio 100 : 1

PFMB Series



### 5 Regulator

Decreases the air consumption by setting to an appropriate pressure

AR Series



### 6 Clean Air Filter

#### For Clean Room

Built-in hollow fiber element Nominal filtration rating: 0.01 μm  
Hollow fiber elements with over 99.99% filtering efficiency do not contaminate workpieces.

SFD Series



\* Please contact SMC for clean room compatible ionizers.

### Clean Air Module

Modularized digital flow switch, regulator, ON/OFF valve, restrictor, and filter

LLB Series



## Related Products

### Polyurethane Coil Tubing

Flexible  
Max. operating pressure: 0.8 MPa (at 20°C)  
For moving applications  
\* Colors other than black are available as made-to-order specifications.

TCU Series



### S Couplers

One-touch fitting type standardized (KK)  
Uses ultra high-impact PBT resin (KKH)



### Finger Valve

The valve direction clearly indicates whether the valve is open or closed.  
Small knob operating force (0.04 to 0.14 N·m)

VHK-A Series

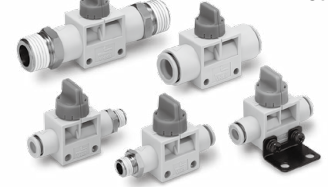



# IZG10 Series

## Specific Product Precautions 1

Be sure to read this before handling the products. Refer to page 227 for safety instructions.

### Selection

#### Warning

- This product is intended to eliminate static electricity from the equipment for factory automation.**  
If considering using the product for other applications (especially those indicated in warning (4) on page 227), please consult with SMC beforehand.
- Do not operate the product beyond the specifications.**  
If the product is used outside of the specification range, it may cause a malfunction, failure or damage to the product, leading to an electric shock, explosion, or fire.
- Do not operate the product outside of the specified ambient temperature and humidity range.**  
Malfunction, failure, or damage to the product can result. Even within the specification range, freezing and condensation can cause a malfunction, failure, or damage in environments where sudden temperature changes and temperature cycles are applied.
- Use within the specified power supply voltage range.**  
Using outside of the specified power supply voltage can cause a malfunction, damage, electric shock, or fire.
- Use clean compressed air as fluid. (A compressed air quality of Class 2.4.3, 2.5.3, 2.6.3, or higher according to ISO 8573-1:2010 (JIS B 8392-1:2012) is recommended for operation.)**  
This product is not explosion proof. Never use flammable gases or explosive gases as a fluid and never use this product in the presence of such gases. Please contact us when fluids other than compressed air are used.
- This product is not explosion-protected.**  
Never use this product in locations where the explosion of dust is likely to occur or flammable or explosive gases are used. This can cause a fire.

#### Caution

- Clean specification is not available with this product.**  
When using in a clean room environment, confirm the required cleanliness before use.  
A minute amount of particles are generated due to wearing of the emitters while the product is operating.

### Wiring / Piping

#### Warning

- Select the power supply capacity based on the product specifications.**  
If the power supply capacity and voltage do not satisfy the product specifications, it will cause product failure or malfunction.
- To maintain product performance, the power supply connected shall be UL listed Class 2 certified by National Electric Code (NEC) or evaluated as a limited power source provided by UL60950.**
- Stop the electrical supply and remove the compressed air supply before any wiring (including insertion and removal of the connector) and piping is performed. Otherwise, an electric shock or accident may occur.**

### Wiring / Piping

#### Warning

- To maintain the product performance, connect the product to power supply cable or AC adapter ground terminal with a resistance value of 100 Ω or less. If the product is not grounded, it is not possible to maintain the performance and may lead to product failure or malfunction.**
- If the ionizer wiring and high-power lines are routed together, this product may malfunction due to noise. Therefore, use a separate wiring route for this product.**
- Flush the piping before use. Before piping this product, please exercise caution to prevent particles, water drops, or oil contents from entering the piping.**
- If a valve is placed immediately before the product, regardless of the operational state of the trigger, instantaneous air release may occur when compressed air is supplied.**
- Confirm that the wiring and piping are correct before supplying power and compressed air. Incorrect wiring and piping will lead to product damage or malfunction.**
- Ensure the safety of wiring, piping, and surrounding conditions before supplying power and compressed air.**

### Handling

#### Warning

- Do not use the product without mounting the designated nozzle.**
- Confirm that the nozzle is not loose and does not have play before supplying compressed air. If the nozzle is loose, tighten it by hand until it stops turning (guideline value for hand tightening torque: 0.1 to 0.2 N·m). Static neutralizing performance is reduced if the nozzle is loose.**
- Be sure to wear protective eyewear when operating the product to protect your eyes from scattering debris.**
- Do not direct the tip of the nozzle at the face or other parts of a human body. It may cause danger to personnel.**
- Do not use the product to clean or remove toxic substances or chemicals.**
- Do not drop, step on, or hit the product. It may cause damage to the product.**
- Do not use the product to disturb public order or public hygiene.**
- This product is not a toy.**
- After blowing, make sure to hang the product on a hook, etc.**

IZS40/41/42

IZT40/41(-L)/  
42(-L)/43(-L)

IZN10E

IZF

IZG10

ZVB

IZD10/IZE11

IZH10

Antistatic  
Equipment



## IZG10 Series

# Specific Product Precautions 2

Be sure to read this before handling the products. Refer to page 227 for safety instructions.

### Handling

#### Warning

**10. Make sure that no twist, turn, tensile force or moment are applied to the One-touch fitting, tube and power cable during use or storage. Such actions may lead to product damage or wire breakage.**

**11. Do not allow foreign matter or tools to enter the nozzle.**

The inside of the nozzle contains emitters. If a metal tool makes contact with the emitters, it can cause an electric shock, resulting in a sudden movement by the operator that can cause further injuries such as hitting the body on peripheral equipment. In addition, if the tool damages the emitter, the ionizer may fail or cause an accident.

#### Danger: High Voltage

Caution: High voltage is being supplied to the emitters. Please do not touch the emitters as there is an electric shock danger when making direct contact or coming within close proximity to them. In addition, one can be injured with evasive actions taken when suddenly removing oneself from the electrical shock danger.



**12. If a valve is placed immediately before the product, regardless of the operational state of the trigger, instantaneous air release may occur when compressed air is supplied.**

**13. If the supply pressure of compressed air is less than the product specification (0.05 MPa), the valve in the product may not operate correctly. Only use the product with a supply pressure within the product specification range.**

### Operating Environment / Storage Environment

#### Warning

**1. Do not use this product in an enclosed space.**

This product utilizes the corona discharge phenomenon. A small amount of ozone and nitrogen oxides will be generated. When the product is used in an enclosed space, the ozone concentration can increase, if so the smell of the ozone may be uncomfortable or irritating. Even if the operating area is not an enclosed space, but multiple products are used in a small area, the ozone concentration can still increase. The operating environment must always be ventilated.

**2. Take preventative measures against ozone.**

Pneumatic equipment used around this product should have ozone-prevention measures in place. In addition, regularly check that there is no deterioration due to ozone present.

**3. Be sure to supply compressed air.**

Static neutralization is not possible without supplying compressed air. Without compressed air, ozone or nitrogen oxides generated by the ion generation process may accumulate and adversely affect the product or peripheral equipment.

**4. Use within the specified ambient temperature range.**

The specified ambient temperature range is 0 to 40°C. Do not use the product in locations where the ambient temperature changes suddenly, even if it stays within the specification range, or if there is a large temperature difference between the fluid and the ambient temperature as condensation may occur as a result.

### Operating Environment / Storage Environment

#### Warning

**5. Environments to avoid**

Avoid using and storing this product in the following environments as they may cause damage to the product.

- Environments where the ambient temperature is outside of the product specification
- Environments where the ambient humidity is outside of the product specification
- Environments where abrupt temperature changes may cause condensation
- Environments where corrosive gases, flammable gases, or other volatile flammable substances are stored
- Environments where the product may be exposed to conductive powder such as iron powder or dust, oil mist, salt, organic solvent, spatter, machining chips, particles, cutting oil (including water and any liquids), etc.
- Environments where ventilated air from an air conditioner is directly applied to the product
- Enclosed or poorly ventilated environments
- Environments that are exposed to direct sunlight or heat radiation
- Environments where strong electromagnetic noise is generated, such as strong electrical and magnetic fields or supply voltage spikes
- Environments where static electricity is generated
- Environments where strong, high frequencies are generated
- Environments that are subject to potential lightning strikes
- Environments where the product may receive direct impact or vibration
- Environments where the product may be subjected to forces or weight that could cause physical deformation

**6. Do not use air containing mist or dust.**

Air containing mist or dust will cause the static neutralization performance to decrease and shorten the maintenance cycle. Install an air dryer (IDF series), air filter (AF/AFF series), and/or mist separator (AFM/AM series) to obtain clean compressed air (A compressed air quality of Class 2.4.3, 2.5.3, 2.6.3, or higher according to ISO 8573-1:2010 (JIS B 8392-1:2012) is recommended for operation.).

**7. This product and AC adapter do not incorporate protection against lightning surges.**

**8. Effects on implantable medical devices**

This product may cause interference with implantable medical devices such as cardiac pacemakers and cardioverter defibrillators, resulting in the malfunction of the medical device or other adverse effects. Please exercise extreme caution when operating equipment which may have an adverse effect on your implantable medical device. Be sure to thoroughly read the precautions stated in the catalog, operation manual, etc., of your implantable medical device, or contact the manufacturer directly for further details on what types of equipment need to be avoided.



## IZG10 Series

# Specific Product Precautions 3

Be sure to read this before handling the products. Refer to page 227 for safety instructions.

### Maintenance

## Warning

### 1. Periodically inspect the ionizer and clean the emitters.

- Check the product regularly to make sure it is not operating with undetected failures.
- Maintenance must be performed by an operator who has sufficient knowledge and experience.
- If the product is used for an extended period with dust present on the emitters, the static neutralization performance will be reduced. It is recommended to clean the emitters periodically. (Emitter contamination level is different depending on the operating environment and supply pressure.)
- When the maintenance LED turns ON, clean the emitters and confirm the static neutralization performance.
- If the static neutralization performance is not recovered after cleaning, it is possible that emitters are worn. Replace the emitter assembly.

## Danger: High Voltage

This product contains a high voltage generation circuit. When performing maintenance or inspection, be sure to confirm that the power supply to the ionizer is turned OFF. Never disassemble or modify the ionizer as this may not only impair the product's functionality but could also cause an electric shock or electric leakage.

### 2. When cleaning or replacing the emitter, be sure to turn OFF the power supply or compressed air supply to the body.

Maintenance of the product with power or compressed air supplies connected can cause an electric shock or accident.

### 3. Securely mount the emitters.

If emitters are not securely mounted, they may eject or release when compressed air is supplied to the product.

### 4. Do not touch the emitters directly.

They have a sharp end and touching them may cause an injury.

### 5. Do not disassemble or modify the product.

Otherwise, an electric shock, damage, and/or a fire may occur. In addition, disassembled or modified products may not achieve the performance guaranteed in the specifications, and the products will no longer be warranted.

### 6. Do not operate the product with wet hands.

Otherwise, an electric shock or accident may occur.

## Caution

### 1. Periodically check the following items and replace the parts if necessary.

- a. Contamination and wear of emitters
- b. Loosening and damage of nozzles
- c. Twists or crushing of connected tubes
- d. Hardness and deterioration of connected tubes
- e. Air leakage

IZS40/41/42

IZT40/41(-L)/  
42(-L)/43(-L)

IZN10E

IZF

IZG10

ZVB

IZD10/IZE11

IZH10

Antistatic  
Equipment